



Prices effective February 5, 2018
Published July 2018

Canvas Office Landscape®

Wall and Private Office

Introduction	page 2
Canvas Office Landscape Wall and Private Office	3
Walls	5
Work Surfaces	177
Storage	330
Screens	423
Lighting	455
Indices	467
By Name	467
By Number	471
Appendices	
20-Day or Less/Assigned Lead-Time Order Information	
Keyed-Alike Information	
Vary Easy Program	
Fire Retardancy-Workspaces	
Stain-to-Match Program	
Surface Edge Styles	
Canvas Office Landscape Connectors and Covers Matrix	
Customer's Own Material/Customer's Own Leather Order Information-Cushion Tops	
Customer's Own Material Order Information-Workspaces	
Proprietary Textiles Application Chart-Workspaces	
Proprietary Textile Colors-Workspaces	
Maharam® Application Chart-Workspaces	
Maharam Colors-Workspaces	
Proprietary Textiles Application Chart-Seating	
Proprietary Textile Colors-Seating	
Maharam® Application Chart-Seating	
Maharam Colors-Seating	
For the latest materials information, refer to the Materials pages on HermanMiller.com.	

Introduction

A Note on the Organization of This Book

There are a few signals that will help you understand the organization of this book. Once you know them, you should be able to find your way around easily.

Like a newspaper, this book is formatted with columns of text and illustrations that run vertically.

Information wraps from one column to the next and continues for as many pages as it needs to.

Black bars are clues.

A black bar at the top of a page signals the start of information about a product.

This information is divided into two sections, each signaled by a black bar. Product Information includes a description, additional notes, and dimensional drawings. Specification Information, which always begins at the top of a column, includes a series of steps. Each step represents a decision you need to make in order to complete your product number. Steps must be followed sequentially. The number of pages needed to complete information on a product varies; some will be complete in one page; others may fill three or four pages. Just continue going through the steps until you run into the next product, signaled by the black bar at the top of the page.

Black tabs running along the outside edge of the page help you locate what section you are in or what section you want to go to. You can thumb forwards or backwards to find a section; tabs and text appear on both sides of the page.

The additional pages in the back of the book include the appendices and indices. They are signaled by a long black bar running along the outside edge of the page.

The index is presented two ways.

The first index is in alphabetical order by product name. It can be helpful if you are new to the products and numbering scheme or if you are looking for a type of product, such as work chair or round table.

The second index is by product number. It lists, in alphanumeric order, the base product number, typically a five-digit number.

This book is effective February 5, 2018, subject to change without notice. Products may be purchased from authorized Herman Miller dealers who will quote prices upon request. For more information about our products and services or to see a list of dealers, visit www.HermanMiller.com.

All prices are list prices in US Dollars. Additional services, such as planning services, design, storage, and installation, are not included and must be added to these prices when the additional services are requested.

Illustrations, specifications, and prices are based on the latest information at the time of publication. The right is reserved to make changes at any time without notice in prices, fabrics, finishes, materials, specifications, and models, and also to discontinue models and finishes.

Dimensions shown in the drawings are engineering drawing dimensions rounded up to the nearest $\frac{1}{8}$ ". Product is shipped set up or knocked down. Products that include "Shipped knocked down" in the description require some assembly. If this statement does not appear in the description, the product is shipped assembled.

Service problems are normally handled by a Herman Miller authorized dealer. Where this cannot be accomplished on a local level, service problems should be referred to the Customer Care Representative for your region, Herman Miller, Inc., Zeeland, Michigan 49464.

20-Day or Less/Assigned Lead-Time Shipments

All products and options in this price book not designated by an Assigned Program icon  will ship in **20 business days or less** after being acknowledged by Herman Miller.

Products and options designated by an  are on the assigned lead-time program and may ship in 20 days, less than 20 days, or more than 20 days from order acknowledgement.

Walls

Work Surfaces

Storage

Screens

Lighting





Frame

FT110.

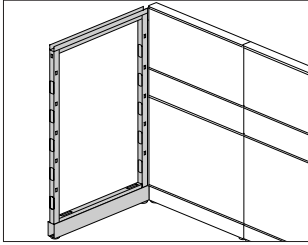

Product Information

Description

This frame holds individual tiles on both sides and is available with an open base with tapered feet, base covers, or no base. Base covers can be specified without knockouts or with knockouts that accept standard-size receptacles and data faceplates.

Notes

For frame with no base option (F), specify architectural foot (FT117.) separately.

Order the following products separately:

- 90° universal connector (FT121.) or frame-to-frame connection hardware (FT128.)
- Frame top cap (FT112.) or Frame top cap, architectural (FT11A.)

Order optional power separately:

- 4-circuit receptacle (FT155. or FT156.)
- Base power harness (FT150.)
- Power harness, low credenza height (FT15A.)
- Power harness, lower power/data tile (FT152.)
- Power harness, upper power/data tile (FT153.)
- Power harness extender (FT151.), for routing power through a connector
- Power jumper (FT154.)

To finish the end of a frame run, order finished end (FT160.) or finished end architectural, (FT16A.) separately.

When connecting 2 unequal-height frames in a straight line, order change-of-height finished end (FT161.) or finished end, architectural, change of height (FT16B.) separately.

35"-high frame cannot have power and data routed above the surface.

42"-high frame connects to 42", 53", 57" and 68"-high frames only.

53"-high frame connects to 42", 53", 68", or 79"-high frames only.

When routing cables horizontally through frame, order cable tray (FT193.) separately. Cable tray is not necessary when routing cables in top channel or in base.

For protection when routing data cabling through openings in frame, order frame grommet (FT194.) separately.

To cover knockout openings, order plastic port covers with service part number 241489 (quantity of 6).

For cable capacity information, see Cable Capacity Charts in Omni.

Dimensions

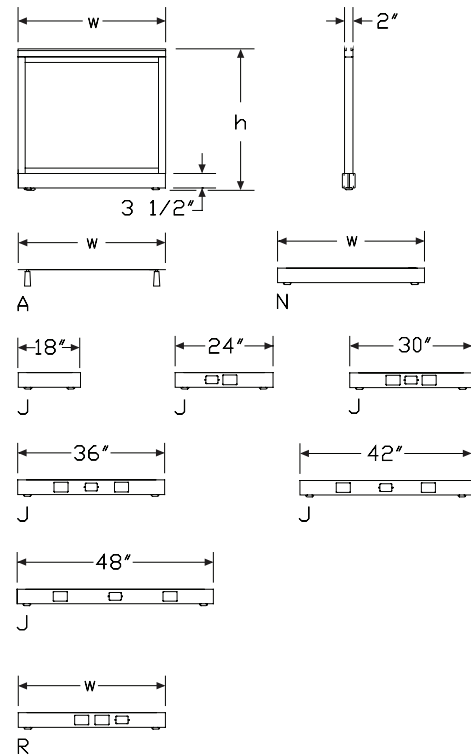

Specification Information

Step 1.

FT110.

Step 2. Height

35	35" high
42	42" high
46	46" high
53	53" high
57	57" high
68	68" high
79	79" high

Step 3. Width

18	18" wide
24	24" wide
30	30" wide
36	36" wide
42	42" wide
48	48" wide

Step 4. Base Option

For 18" wide (18)

A	open base, tapered foot
N	base covers, no knockouts
X	no base covers
F	no base, for use with architectural foot

For 24" wide (24), 30" wide (30), 36" wide (36), 42" wide (42), or 48" wide (48)

A	open base, tapered foot
N	base covers, no knockouts
J	base covers, power/data knockouts
R	base covers, power/data knockouts (meets Chicago electrical code requirements)
X	no base covers
F	no base, for use with architectural foot

Prices for Steps 1-4.

	A	N	J	R	X	F
FT110. 35 18	\$146	166	—	—	135	135
24	\$154	177	186	189	142	142
30	\$162	189	183	201	149	149
36	\$173	199	210	214	156	156
42	\$186	212	223	226	162	162
48	\$198	227	238	245	170	170

42 18	\$152	178	—	—	144	144
24	\$160	186	195	199	149	149
30	\$170	195	205	210	157	157
36	\$182	208	219	222	163	163
42	\$192	221	232	235	168	168
48	\$204	235	248	251	177	177
46 18	\$155	183	—	—	147	147
24	\$165	191	201	204	154	154
30	\$177	200	211	216	160	160
36	\$187	212	223	226	170	170
42	\$198	226	237	244	179	179
48	\$211	240	253	257	187	187
53 18	\$165	189	—	—	158	158
24	\$173	198	209	212	165	165
30	\$183	208	219	223	173	173
36	\$193	220	231	235	183	183
42	\$204	233	246	249	191	191
48	\$217	247	259	264	199	199
57 18	\$174	194	—	—	167	167
24	\$181	203	214	219	176	176
30	\$189	214	225	230	185	185
36	\$199	226	237	244	194	194
42	\$211	238	251	256	202	202
48	\$224	253	266	270	211	211
68 18	\$183	204	—	—	178	178
24	\$192	216	227	232	188	188
30	\$201	227	238	245	198	198
36	\$212	238	251	256	210	210
42	\$224	251	264	269	221	221
48	\$235	266	280	285	230	230
79 18	\$242	269	—	—	234	234
24	\$253	281	295	300	246	246
30	\$266	292	307	313	258	258
36	\$278	306	322	329	271	271
42	\$291	319	335	341	284	284
48	\$303	332	350	356	296	296

Frame *continued*

Step 5. Base Finish

For base covers, no knockouts (N), base covers, power/data knockouts (I), or base covers, power/data knockouts (meets Chicago electrical code requirements) (R)

91	white	+\$0
CL	cool grey neutral	+\$0
G1	graphite	+\$0
WN	warm grey neutral	+\$0
8Q	folkstone grey	+\$0
98	studio white	+\$0
WL	sandstone	+\$0
CN	metallic champagne	+\$0
EH	metallic bronze	+\$0
MS	metallic silver	+\$0

Gallery Panel

FT115.

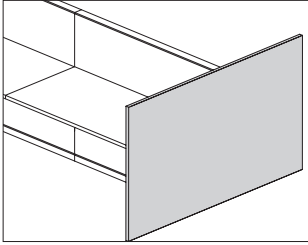

Canvas Office Landscape® Walls

Product Information

Description

This structural panel stands on the floor and attaches to a frame of equal height or taller to provide end of run support and privacy. It is 1 1/4" thick and has a laminate surface with thermoplastic edge, laminate surface with a thermoplastic backed plywood edge, or veneer surface and edge. Leveling glides and attachment hardware included.

Notes

Gallery panels 24"-72" wide are a single panel construction; 84"-144" wide are a 3 panel construction.

Attachment direction is determined by facing the gallery panel from outside the workstation. Left attachment (L) connects the left side of a gallery panel to the end of a frame. Right attachment (R) connects the right side of a gallery panel to the end of a frame. Mid attachment (M) connects the middle of a gallery panel to the end of a frame.

Mid-attached gallery panels are 3" wider than nominal dimensions.

Gallery panels 72" wide and wider require attachment to adjacent surfaces; hardware is included.

When connected to a frame of unequal height specify a Finished End, for use with Gallery Panel (FT16G.) separately.

Leveling glides provide 2" of adjustment.

29"-high gallery panels are compatible with 6", 13", or 17"-high finished ends (FT16G.).

35"-high gallery panels are compatible with 7", 11", 18", or 22"-high finished ends (FT16G.).

42"-high gallery panels are compatible with 11" or 15"-high finished ends (FT16G.).

46"-high gallery panels are compatible with 7" or 11"-high finished ends (FT16G.).

Grain direction is vertical on veneer and wood-grain laminate panel.

For additional product options, see Vary Easy Program in appendices.

Dimensions

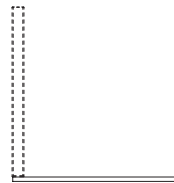
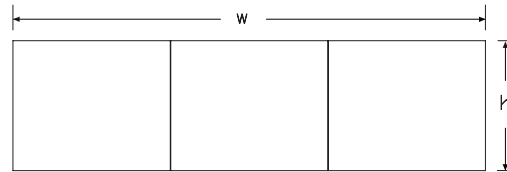
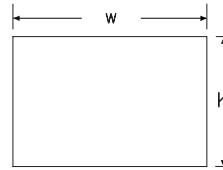

Left Attachment

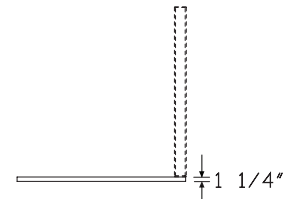

Right Attachment

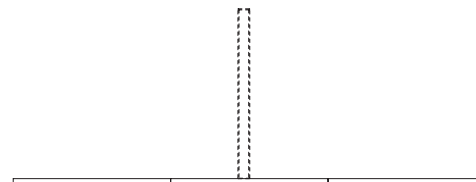

Mid Attachment

Specification Information	
Step 1.	
FT115.	A
Step 2. Height	
29	29" high A
35	35" high A
42	42" high A
46	46" high A
Step 3. Width	
24	24" wide A
30	30" wide A
36	36" wide A
42	42" wide A
48	48" wide A
60	60" wide A
72	72" wide A
84	84" wide A
96	96" wide A
120	120" wide A
144	144" wide A
Step 4. Surface Material	
L	laminate/thermoplastic edge A
W	veneer A
U	laminate/universal edge A
Step 5. Attachment Method	
<i>For 24" wide (24), 30" wide (30), 36" wide (36), or 42" wide (42)</i>	
L	left attachment A
R	right attachment A
<i>For 48" wide (48), 60" wide (60), or 72" wide (72)</i>	
M	mid attachment A
L	left attachment A
R	right attachment A
<i>For 84" wide (84), 96" wide (96), 120" wide (120), or 144" wide (144)</i>	
M	mid attachment A

Prices for Steps 1-5.						
	LM	LL	LR	WM	WL	WR
FT115. 29 24	—	\$334	334	—	674	674
30	—	\$409	409	—	898	898
36	—	\$460	460	—	1010	1010
42	—	\$537	537	—	1179	1179
48	\$613	613	613	1348	1348	1348
60	\$715	715	715	1572	1572	1572
72	\$817	817	817	1796	1796	1796
84	\$1090	—	—	2245	—	—
96	\$1190	—	—	2470	—	—
120	\$1327	—	—	2918	—	—
144	\$1531	—	—	3367	—	—
35 24	—	\$409	409	—	898	898
30	—	\$511	511	—	1123	1123
36	—	\$562	562	—	1236	1236
42	—	\$639	639	—	1403	1403
48	\$715	715	715	1572	1572	1572
60	\$817	817	817	1796	1796	1796
72	\$919	919	919	2020	2020	2020
84	\$1190	—	—	2470	—	—
96	\$1290	—	—	2694	—	—
120	\$1429	—	—	3143	—	—
144	\$1633	—	—	3592	—	—
42 24	—	\$460	460	—	1010	1010
30	—	\$562	562	—	1236	1236
36	—	\$613	613	—	1348	1348
42	—	\$689	689	—	1515	1515
48	\$766	766	766	1684	1684	1684
60	\$868	868	868	1908	1908	1908
72	\$970	970	970	2133	2133	2133
84	\$1290	—	—	2694	—	—
96	\$1390	—	—	2918	—	—
120	\$1531	—	—	3367	—	—
144	\$1735	—	—	3816	—	—
46 24	—	\$511	511	—	1123	1123
30	—	\$613	613	—	1348	1348
36	—	\$664	664	—	1460	1460
42	—	\$741	741	—	1628	1628
48	\$817	817	817	1796	1796	1796
60	\$919	919	919	2020	2020	2020
72	\$1021	1021	1021	2245	2245	2245
84	\$1390	—	—	2918	—	—
96	\$1490	—	—	3143	—	—
120	\$1633	—	—	3592	—	—
144	\$1837	—	—	4040	—	—

		UM	UL	UR
FT115.	29	—	\$303	303
	30	—	\$404	404
	36	—	\$455	455
	42	—	\$531	531
	48	\$606	606	606
	60	\$707	707	707
	72	\$808	808	808
	84	\$1010	—	—
	96	\$1111	—	—
	120	\$1313	—	—
	144	\$1515	—	—
	35	—	\$404	404
	30	—	\$505	505
	36	—	\$556	556
	42	—	\$632	632
	48	\$707	707	707
	60	\$808	808	808
	72	\$909	909	909
	84	\$1111	—	—
	96	\$1212	—	—
	120	\$1414	—	—
	144	\$1616	—	—
	42	—	\$455	455
	30	—	\$556	556
	36	—	\$606	606
	42	—	\$682	682
	48	\$758	758	758
	60	\$859	859	859
	72	\$960	960	960
	84	\$1212	—	—
	96	\$1313	—	—
	120	\$1515	—	—
	144	\$1717	—	—
	46	—	\$505	505
	30	—	\$606	606
	36	—	\$657	657
	42	—	\$733	733
	48	\$808	808	808
	60	\$909	909	909
	72	\$1010	1010	1010
	84	\$1313	—	—
	96	\$1414	—	—
	120	\$1616	—	—
	144	\$1818	—	—

Step 6.

Surface Finish

For 24" wide (24), 30" wide (30), 36" wide (36), 42" wide (42), 48" wide (48), 84" wide (84), 96" wide (96), 120" wide (120), or 144" wide (144) with laminate/thermoplastic edge (L), or laminate/universal edge (U)

8Q	folkstone grey	A	+\$0
91	white	A	+\$0
98	studio white	A	+\$0
CL	cool grey neutral	A	+\$0
HF	inner tone light	A	+\$0
HT	inner tone	A	+\$0
LU	soft white	A	+\$0
WL	sandstone	A	+\$0
WN	warm grey neutral	A	+\$0
HM	natural maple	A	+\$0
HP	light anigre	A	+\$0
HX	aged cherry	A	+\$0
HY	walnut on cherry	A	+\$0
LA	light ash	A	+\$0
LBA	clear on ash	A	+\$0
LBR	phantom ecru	A	+\$0
LBS	phantom cocoa	A	+\$0
LBU	medium matte walnut	A	+\$0
LBV	warm grey teak	A	+\$0
LBB	oak on ash	A	+\$0
LBC	walnut on ash	A	+\$0
LBD	dark brown walnut	A	+\$0
LBE	medium red walnut	A	+\$0
LBF	neutral twill	A	+\$0
LBG	sarum twill	A	+\$0
LBH	earthen twill	A	+\$0
LBJ	graphite twill	A	+\$0
LBQ	white twill	A	+\$0
LBK	pewter mesh	A	+\$0
LBL	steel mesh	A	+\$0
LBM	crisp linen	A	+\$0
LBN	classic linen	A	+\$0
LBP	casual linen	A	+\$0

Gallery Panel *continued*

Surface Finish

For 60" wide (60) or 72" wide (72) with laminate/thermoplastic edge (L),
or laminate/universal edge (U)

8Q	folkstone grey <input type="checkbox"/>	+\$0
91	white <input type="checkbox"/>	+\$0
98	studio white <input type="checkbox"/>	+\$0
CL	cool grey neutral <input type="checkbox"/>	+\$0
LU	soft white <input type="checkbox"/>	+\$0
WL	sandstone <input type="checkbox"/>	+\$0
WN	warm grey neutral <input type="checkbox"/>	+\$0

Surface Finish

For 60" wide (60) or 72" wide (72) with laminate/thermoplastic edge (L),
or laminate/universal edge (U)

LBM	crisp linen <input type="checkbox"/>	+\$0
LBN	classic linen <input type="checkbox"/>	+\$0
LBP	casual linen <input type="checkbox"/>	+\$0

Surface Finish

For 60" wide (60) or 72" wide (72) with laminate/thermoplastic edge (L),
or laminate/universal edge (U)

LBK	pewter mesh <input type="checkbox"/>	+\$0
LBL	steel mesh <input type="checkbox"/>	+\$0

Surface Finish

For 60" wide (60) or 72" wide (72) with laminate/thermoplastic edge (L),
or laminate/universal edge (U)

28	canyon <input type="checkbox"/>	+\$0
29	misted <input type="checkbox"/>	+\$0

Surface/Edge Finish

For veneer (W)

DU	cathedral recut natural maple <input type="checkbox"/>	+\$85
HU	cathedral recut light anigre <input type="checkbox"/>	+\$85
JU	cathedral recut aged cherry <input type="checkbox"/>	+\$85
VU	cathedral recut light brown walnut <input type="checkbox"/>	+\$85
WU	cathedral recut walnut on cherry <input type="checkbox"/>	+\$85
XU	cathedral recut medium red cherry <input type="checkbox"/>	+\$85
ZU	cathedral recut chocolate brown sapele <input type="checkbox"/>	+\$85

Surface/Edge Finish

For veneer (W)

2U	light brown walnut <input type="checkbox"/>	+\$85
3U	medium red cherry <input type="checkbox"/>	+\$85
40	dark brown walnut <input type="checkbox"/>	+\$85
6U	chocolate brown sapele <input type="checkbox"/>	+\$85
ED	aged cherry <input type="checkbox"/>	+\$85
EK	medium red walnut <input type="checkbox"/>	+\$85
EW	medium matte walnut <input type="checkbox"/>	+\$85
ET	clear on ash <input type="checkbox"/>	+\$85
EU	oak on ash <input type="checkbox"/>	+\$85
EV	walnut on ash <input type="checkbox"/>	+\$85
UL	natural maple <input type="checkbox"/>	+\$85
UX	walnut on cherry <input type="checkbox"/>	+\$85

Gallery Panel *continued*

Step 7. Edge Finish

For laminate/thermoplastic edge (L)

76	light brown walnut <input type="checkbox"/>	+\$0
8Q	folkstone grey <input type="checkbox"/>	+\$0
91	white <input type="checkbox"/>	+\$0
98	studio white <input type="checkbox"/>	+\$0
CL	cool grey neutral <input type="checkbox"/>	+\$0
LA	light ash <input type="checkbox"/>	+\$0
LBA	clear on ash <input type="checkbox"/>	+\$0
LBR	phantom ecru <input type="checkbox"/>	+\$0
LBS	phantom cocoa <input type="checkbox"/>	+\$0
LBU	medium matte walnut <input type="checkbox"/>	+\$0
LBV	warm grey teak <input type="checkbox"/>	+\$0
LBB	oak on ash <input type="checkbox"/>	+\$0
LBC	walnut on ash <input type="checkbox"/>	+\$0
LBD	dark brown walnut <input type="checkbox"/>	+\$0
LBE	medium red walnut <input type="checkbox"/>	+\$0
LBF	neutral twill <input type="checkbox"/>	+\$0
LBG	sarum twill <input type="checkbox"/>	+\$0
LBH	earthen twill <input type="checkbox"/>	+\$0
LBJ	graphite twill <input type="checkbox"/>	+\$0
LBK	pewter mesh <input type="checkbox"/>	+\$0
LBL	steel mesh <input type="checkbox"/>	+\$0
LBM	crisp linen <input type="checkbox"/>	+\$0
LBN	classic linen <input type="checkbox"/>	+\$0
LBP	casual linen <input type="checkbox"/>	+\$0
LBQ	white twill <input type="checkbox"/>	+\$0
WL	sandstone <input type="checkbox"/>	+\$0
WN	warm grey neutral <input type="checkbox"/>	+\$0
HF	inner tone light <input type="checkbox"/>	+\$0
HM	natural maple <input type="checkbox"/>	+\$0
HP	light anigre <input type="checkbox"/>	+\$0
HT	inner tone <input type="checkbox"/>	+\$0
HX	aged cherry <input type="checkbox"/>	+\$0
HY	walnut on cherry <input type="checkbox"/>	+\$0
LU	soft white <input type="checkbox"/>	+\$0

For laminate/universal edge (U)

PLY	plywood edge <input type="checkbox"/>	+\$50
------------	---------------------------------------	-------

Architectural Foot

FT117.

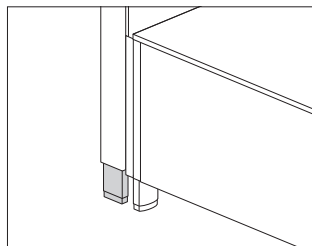

Product Information

Description

This individual foot supports 1 end of a frame, adjacent frames within a run, or multiple frames at a 2-, 3-, or 4-way connection. It has 2" leveling adjustability. Attachment hardware included.

Notes

Specify frame(s) with no base, for use with architectural foot option (FT110.xxxxF).

Dimensions

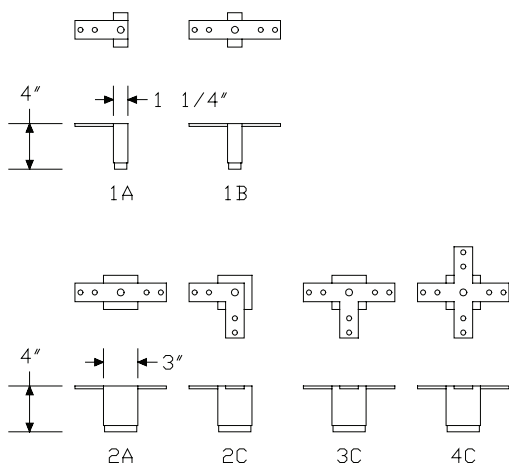

Specification Information

Step 1.

FT117.

Step 2. Configuration

- 1A** end-of-frame
- 1B** shared, frame-to-frame connection
- 2C** 2-way 90° connection
- 2A** 2-way 180° connection
- 3C** 3-way 90° connection
- 4C** 4-way 90° connection

Prices for Steps 1-2.

FT117. 1A	\$119
1B	\$125
2C	\$236
2A	\$236
3C	\$241
4C	\$248

Step 3. Surface Finish

8Q folkstone grey	+\$0
98 studio white	+\$0
WL sandstone	+\$0

Bright Sand Texture Paint

91 white	+\$0
CL cool grey neutral	+\$0
G1 graphite	+\$0
WN warm grey neutral	+\$0

Metallic Paint

CN metallic champagne	+\$0
EH metallic bronze	+\$0
MS metallic silver	+\$0

Support Bracket, Low Credenza-to-Frame

FT292.

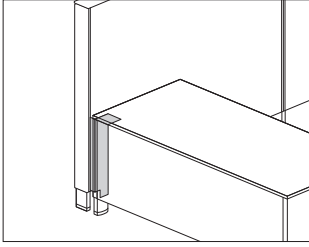

Canvas Office Landscape® Walls

Product Information

Description

This bracket attaches between a Canvas wood or metal credenza and a frame. It allows the credenza to attach parallel or perpendicular to the frame, providing support to a frame run in place of a return wall or work surface support.

Notes

Bracket attaches credenza with no gap or with a 1" gap from the front of the frame to allow room for cords and cables.

Support bracket attaches to low credenza with 4" foot only.

Support bracket also attaches to back of a 60" wide or wider low credenza where 2 units are joined.

Support bracket orientation (left or right) is determined by the frame orientation as you are facing the frame. Credenza can be attached parallel or perpendicular to a frame. Bracket attaches to the back left or back right of the low credenza.

Dimensions

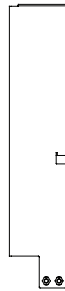
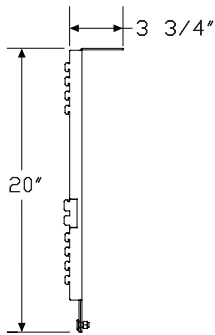
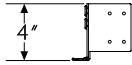

Specification Information

Step 1.

FT292.

Step 2. Storage Type

M for use with metal low credenza with 4" high foot

C for use with wood low credenza with 4" high foot A

Step 3. Frame Attachment Location

L left end of frame

R right end of frame

Step 4. Storage Attachment Position

N no gap, for storage tight to wall

G 1" gap, for cord drop

Prices for Steps 1-4.

		N	G
FT292.	M L	\$129	129
	R	\$129	129
	C L	\$129	129
	R	\$129	129

Step 5. Surface Finish

Bright Sand Texture Paint

91	white	+\$0
CL	cool grey neutral	+\$0
G1	graphite	+\$0
WN	warm grey neutral	+\$0
8Q	folkstone grey	+\$0
98	studio white	+\$0
WL	sandstone	+\$0

Metallic Paint

CN	metallic champagne	+\$0
EH	metallic bronze	+\$0
MS	metallic silver	+\$0

Stacking Frame

FT111.

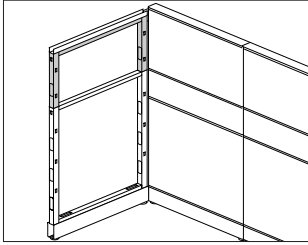

Product Information

Description

This frame attaches to the top of a base frame to extend the overall height and holds individual tiles on both sides. Attachment hardware is included for attaching the stacking frame to the base frame and an adjacent in-line frame. Light seal included; finish is black.

Notes

A maximum of one 22"-high or two 11"-high stacking frames can attach to a frame; the total frame height cannot exceed 90".

53"-high frame can accept one 11"-high stacking frame.

Stacking frame cannot be used on top of a window tile or open tile.

To finish exposed end of frame, order finished end (FT160.) or finished end, architectural (FT16A.) separately.

When adjacent frames are same height or higher than stacked frame, order 90° universal stacking connector (FT122.) separately.

When stacking frames are the same height at a corner connector, order connector cover to match the overall height of the 2 frames.

For appropriate planning applications, see Canvas Planning Guide.

Dimensions

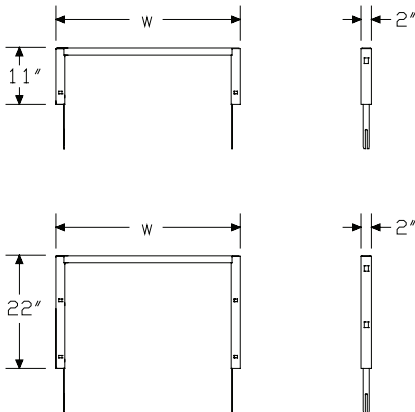

Specification Information

Step 1.

FT111.

Step 2. Height

11	11" high
22	22" high

Step 3. Width

18	18" wide
24	24" wide
30	30" wide
36	36" wide
42	42" wide
48	48" wide

Prices for Steps 1-3.

		18	24	30	36	42	48
FT111. 11		\$142	148	155	161	167	174
	22	\$155	161	167	174	182	188

Step 4. Application

LD	stacking on 35", 46", 57", 68", 79" base frame	+\$0
JL	stacking on 42" or 53"-high base frame	+\$40

Top Channel Cable Support

FT910.

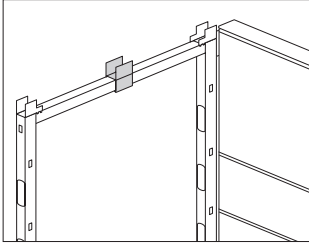

Canvas Office Landscape® Walls

Product Information

Description

This optional cable support clips to the top of a frame to provide extra support for cables routed in the top channel prior to tile installation.

Package of 12.

Notes

Use 1 support per frame for 24"- and 30"-wide frames. Use 2 supports per frame for 36", 42", and 48"-wide frames.

Top channel cable support does not interfere with attachment of tiles.

Dimensions

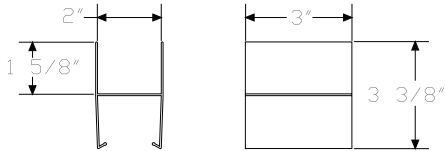

Specification Information

Step 1.

FT910.12

\$48

Thin-Profile Stacking Window

FT187.

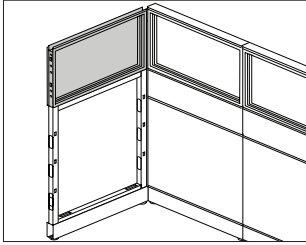

Product Information

Description

This window stacks on top of a frame or stacking frame and is finished on both sides. It has a thin-profile frame, $\frac{1}{8}$ "-thick single-pane glass or acrylic insert, and a horizontal bead along the top. A limited number of cables can be routed along the top channel. Attachment hardware is included for attaching the stacking window to the base frame and an adjacent in-line frame. Light seal included; finish is black.

A maximum of 1 22"-high or 11"-high window can stack on a frame; the overall height (frame plus stacking window) cannot exceed 90". Stacking window cannot be used above a window tile or open tile.

Notes

53"-high frame can accept one 11"-high stacking window.

Specify 18", 24", 30", 36", 42" or 48"-wide stacking window to match width of frame. Specify 60", 66", 72", 78", 84", 90", or 96"-wide stacking window to span 2 frames.

18", 24", 30", 36", 42", and 48"-wide stacking windows have a tempered glass insert. 60", 66", 72", 78", 84", 90", and 96"-wide windows have an acrylic insert.

Order frame top cap (FT112.) or frame top cap, architectural (FT11A.) separately.

Components cannot hang from stacking window.

22" thin profile stacking window is not compatible with privacy door lock post (FT118. or FT992.).

When adjacent frames are the same height or higher than stacking window at a corner connector, order 90° universal stacking connector (FT122.) separately.

When frames and stacking windows are the same height at a corner connector, order connector cover to match the overall height.

To finish exposed end of frame and stacking window, order finished end (FT160.) or finished end, architectural (FT16A.) separately to match combined height of frame and stacking window.

A frame with a thin-profile stacking window (FT187.) cannot be placed off module to a spine wall frame.

For cable capacity information, see Cable Capacity Charts in Omni.

Dimensions

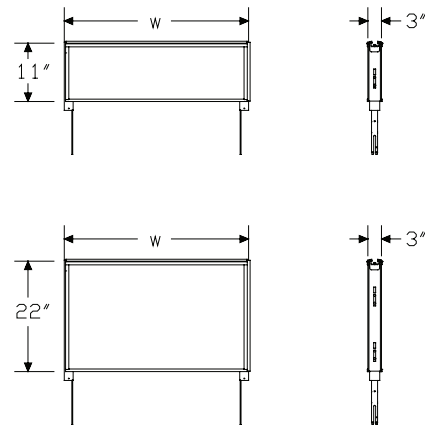

Thin-Profile Stacking Window

continued

Specification Information

Step 1.

FT187.

Step 2. Height

11	11" high
22	22" high

Step 3. Width

For 11" high (11)

18	18" wide
24	24" wide
30	30" wide
36	36" wide
42	42" wide
48	48" wide
60	60" wide
66	66" wide
72	72" wide
78	78" wide
84	84" wide
90	90" wide
96	96" wide

For 22" high (22)

18	18" wide
24	24" wide
30	30" wide
36	36" wide
42	42" wide
48	48" wide

Prices for Steps 1-3.

	18	24	30	36	42	48
FT187. 11	\$312	340	368	395	425	453
22	\$407	437	471	505	542	575
	60	66	72	78	84	90
FT187. 11	\$625	648	740	767	792	821
						96
FT187. 11						\$847

Step 4. Frame Finish

Bright Sand Texture Paint

8Q	folkstone grey	+\$0
91	white	+\$0
CL	cool grey neutral	+\$0
G1	graphite	+\$0
WN	warm grey neutral	+\$0
98	studio white	+\$0
WL	sandstone	+\$0

Metallic Paint

CN	metallic champagne	+\$0
EH	metallic bronze	+\$0
MS	metallic silver	+\$0

Step 5. Glass Finish

TR	clear	+\$0
34	opal glaze	+\$50

Step 6. Horizontal Bead Finish

8Q	folkstone grey	+\$0
91	white	+\$0
98	studio white	+\$0
CL	cool grey neutral	+\$0
G1	graphite	+\$0
LU	soft white	+\$0
MT	medium tone	+\$0
WL	sandstone	+\$0
WN	warm grey neutral	+\$0
CN	metallic champagne	+\$0
EH	metallic bronze	+\$0
MS	metallic silver	+\$0

Step 7. Application

LD	stacking on 35", 46", 57", 68", 79" base frame	+\$0
JL	stacking on 42" or 53"-high base frame	+\$40

Privacy Door

FT118.

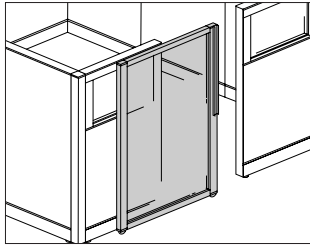

Product Information

Description

This sliding door provides enclosure and added privacy to a workstation. It has an aluminum frame, urethane wheels, and a fabric or plastic infill. The door attaches to an equal-height frame and is specified to close to the left or right. The lock option locks the door from outside the workstation; a built-in safety feature allows the door to be unlocked from the inside.

Door handle and lock assembly conform to the Americans with Disabilities Act (ADA) guidelines.

Notes

Door and adjacent frames must be the same height.

To use privacy door with architectural trim, order frame top cap, architectural, privacy door (FT11B.) separately.

Door attachment is identified when facing the door from outside the station. A left (L6) door attaches to a frame on the left. A right (R6) door attaches to a frame on the right.

Door direction cannot be reversed in the field.

Privacy door lock post is not compatible with 22" high thin profile stacking window (FT187.22xx).

Fluted translucent infill option (FW) has a Class A fire-retardant rating.

For fluted translucent infill option (FW), flute direction is vertical.

Clear (TR) and opal frosted (J) infills are acrylic.

Opal frosted (J) infill complements opal glass.

For keyed-alike locks, see Keyed-Alike Information in Appendices.

Dimensions

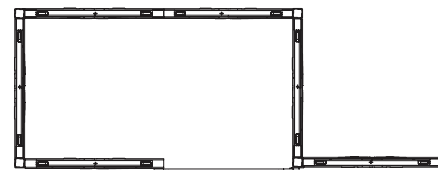
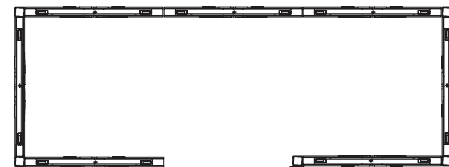
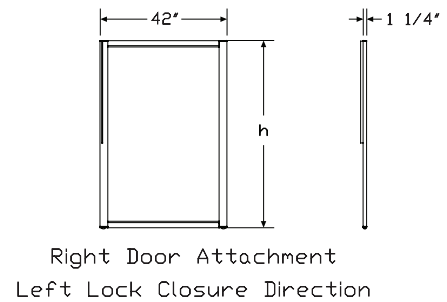
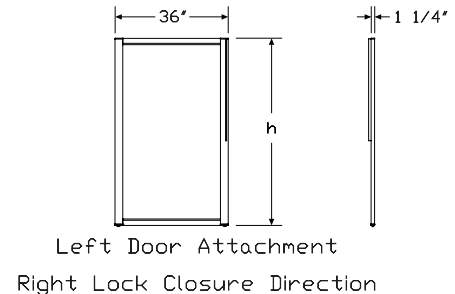

Specification Information

Step 1.

FT118. A

Step 2. Height

57 57" high A

68 68" high A

Step 3. Width

36 36" wide A

42 42" wide A

Step 4. Material

A translucent plastic A

F fabric A

Step 5. Door Attachment

L6 left A

R6 right A

Step 6. Lock Application

NFA in-line frame attachment A

CCA corner connector attachment A

Prices for Steps 1-6.

		AL6NFA	AL6CCA	AR6NFA	AR6CCA	FL6NFA	FL6CCA
FT118. 57	36	\$2419	2419	2419	2419	3337	3337
	42	\$2484	2484	2484	2484	3412	3412
68	36	\$2504	2504	2504	2504	3439	3439
	42	\$2577	2577	2577	2577	3523	3523

		FR6NFA	FR6CCA
FT118. 57	36	\$3337	3337
	42	\$3412	3412
68	36	\$3439	3439
	42	\$3523	3523

Step 7. Lock

NL no lock A +\$0

KA keyed alike A +\$270

KD keyed differently A +\$270

Step 8. Frame Finish

8Q folkstone grey A +\$0

98 studio white A +\$0

WL sandstone A +\$0

Bright Sand Texture Paint

91 white A +\$0

CL cool grey neutral A +\$0

G1 graphite A +\$0

WN warm grey neutral A +\$0

Metallic Paint

CN metallic champagne A +\$0

EH metallic bronze A +\$0

MS metallic silver A +\$0

Step 9. Infill Finish

For fabric (F)

Price Category 1 +\$0

Price Category 2 +\$73

Price Category 3 +\$131

Price Category 4 +\$197

Price Category 5 +\$323

Price Category B +\$151

Price Category C +\$226

Price Category D +\$299

Price Category E +\$347

For translucent plastic (A)

FW fluted translucent A +\$0

TR clear A +\$335

J9 opal frosted A +\$955

Privacy Door Lock Post Kit

FT992.

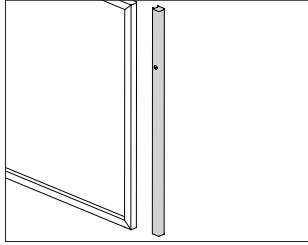

Product Information

Description

This kit converts a non-locking privacy door to a locking privacy door. It locks the door from outside the workstation. It includes a safety latch allowing the door to be unlocked from inside the workstation. Lock assembly conforms to the Americans with Disabilities Act (ADA) guidelines.

Notes

Specify lock kit left attachment (FT992.xxL) for use with left-attached door (FT118.xxxxL6).
 Specify lock kit right attachment (FT992.xxR) for use with right-attached door (FT118.xxxxR6).
 Privacy door lock post is not compatible with 22" high thin profile stacking window (FT187.22xx).
 For keyed-alike locks, order lock plugs separately. See Keyed-Alike Information in Appendices.

Dimensions

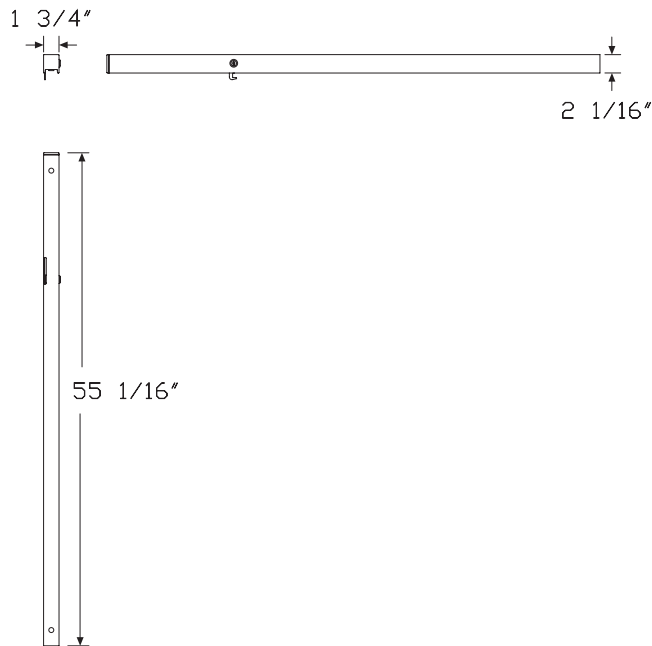

Specification Information

Step 1.

FT992. A

Step 2. Height

57 57" high A
68 68" high A

Step 3. Attachment

L left A
R right A

Step 4. Application

F in-line frame attachment A
C corner connector attachment A

Prices for Steps 1-4.

	F	C
FT992. 57 L	\$423	423
R	\$423	423
68 L	\$462	462
R	\$462	462

Step 5. Lock Option

KA keyed alike <input type="checkbox"/> A	-\$10
KD keyed differently <input type="checkbox"/> A	+\$0
NL no lock <input type="checkbox"/> A	+\$0

Step 6. Finish

8Q folkstone grey <input type="checkbox"/> A	+\$0
98 studio white <input type="checkbox"/> A	+\$0
WL sandstone <input type="checkbox"/> A	+\$0

Bright Sand Texture Paint

91 white <input type="checkbox"/> A	+\$0
CL cool grey neutral <input type="checkbox"/> A	+\$0
G1 graphite <input type="checkbox"/> A	+\$0
WN warm grey neutral <input type="checkbox"/> A	+\$0

Metallic Paint

CN metallic champagne <input type="checkbox"/> A	+\$0
EH metallic bronze <input type="checkbox"/> A	+\$0
MS metallic silver <input type="checkbox"/> A	+\$0

Upmount Screen

FT113.

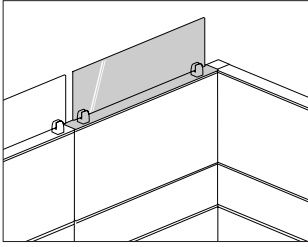

Canvas Office Landscape® Walls

Product Information

Description

This 11"-high glass screen attaches to the top of a frame to increase overall height. Frame top cap and attachment brackets included.

Notes

Glass is 3/4" thick.

Match width of upmount screen to frame width.

Cables cannot be routed along top channel of frame where screen is attached.

Screen cannot attach to top of thin-profile stacking window (FT187.).

A frame with upmount screen (FT113.) cannot be placed off module to a spine wall frame.

Dimensions

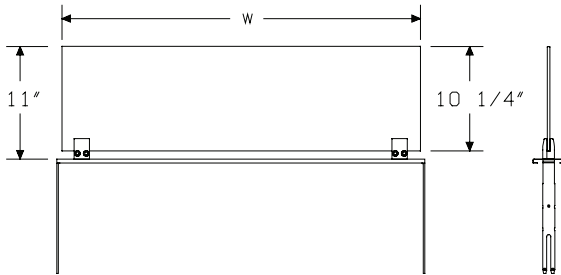

Specification Information

Step 1.

FT113.1

Step 2. Width

18G	18" wide
24G	24" wide
30G	30" wide
36G	36" wide
42G	42" wide
48G	48" wide

Step 3. Top Cap Material

P	painted standard top cap
W	veneer standard top cap A
A	painted architectural top cap

Prices for Steps 1-3.

		P	W	A
FT113.1	18G	\$242	319	301
	24G	\$254	342	324
	30G	\$272	377	352
	36G	\$289	413	377
	42G	\$307	448	404
	48G	\$324	482	433

Step 4. Screen Finish

TR	clear			+\$0
34	opal glaze			+\$50
5A	opal etched			+\$50
NN	no glass- for customer's own glass A			-\$150

Step 5. Clip Finish

Bright Sand Texture Paint

8Q	folkstone grey			+\$0
91	white			+\$0
98	studio white			+\$0
CL	cool grey neutral			+\$0
G1	graphite			+\$0
WL	sandstone			+\$0
WN	warm grey neutral			+\$0

Metallic Paint

CN	metallic champagne			+\$0
EH	metallic bronze			+\$0
MS	metallic silver			+\$0

Step 6. Top Cap Finish

For painted standard top cap (P) or painted architectural top cap (A)

8Q	folkstone grey	+\$0
91	white	+\$0
98	studio white	+\$0
CL	cool grey neutral	+\$0
G1	graphite	+\$0
WL	sandstone	+\$0
WN	warm grey neutral	+\$0

For painted standard top cap (P) or painted architectural top cap (A)

CN	metallic champagne	+\$0
EH	metallic bronze	+\$0
MS	metallic silver	+\$0

For veneer standard top cap (W)

2U	light brown walnut <input type="checkbox"/>	+\$0
40	dark brown walnut <input type="checkbox"/>	+\$0
ED	aged cherry <input type="checkbox"/>	+\$0
EK	medium red walnut <input type="checkbox"/>	+\$0
EW	medium matte walnut <input type="checkbox"/>	+\$0
ET	clear on ash <input type="checkbox"/>	+\$0
EU	oak on ash <input type="checkbox"/>	+\$0
EV	walnut on ash <input type="checkbox"/>	+\$0
UL	natural maple <input type="checkbox"/>	+\$0
UX	walnut on cherry <input type="checkbox"/>	+\$0

Step 7. Application

LD	stacking on 35", 46", 57", 68", 79" base frame	+\$0
JL	stacking on 42" or 53"-high base frame	+\$40

Frame Top Screen

FT114.

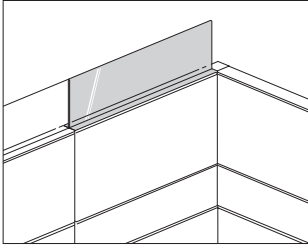

Canvas Office Landscape® Walls

Product Information

Description

This glass screen attaches to the top of a frame (or frames) to increase the overall height. It has concealed attachment brackets that eliminate the gap between the top of the frame and the bottom of the screen. Frame top cap and attachment hardware included.

Notes

Specify width of screen to match the width of 1 frame, or the combined width of 2 frames.

18"- to 48"-wide frame top screens can only span 1 frame. 54"-wide and wider can span 2 frames.

Cables cannot be routed along top channel of frame where screen is attached.

Screen cannot attach to top of thin-profile stacking window (FT187.)

Screen cannot be used in in-line, frame-to-frame, change-of-height applications.

Screen cannot be used on frames with veneer finished ends.

Screen cannot be used next to connector-attached power poles (FT143., FT14A.).

A frame with a frame top screen (FT114.) cannot be placed off module to a spine wall frame.

Options (F) and (G) are for 54"-wide and wider top cap to span the combined width of 2 adjacent frames placed between 2 universal connectors or a universal connector and a finished end.

Options (H) and (J) are for 54"-wide and wider top cap to span the combined width of 2 adjacent frames in runs of 3 frames or more.

Dimensions

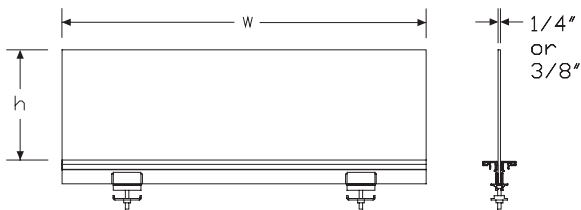

Specification Information

Step 1.

FT114.

Step 2. Height

07	7" high
11	11" high
15	15" high

Step 3. Width

18	18" wide
24	24" wide
30	30" wide
36	36" wide
42	42" wide
48	48" wide
54	54" wide
60	60" wide
66	66" wide
72	72" wide
78	78" wide
84	84" wide
90	90" wide
96	96" wide

Step 4. Top Cap Material

For 18" wide (18), 24" wide (24), 30" wide (30), 36" wide (36), 42" wide (42), or 48" wide (48)

- A painted architectural top cap A
- P painted standard top cap

For 54" wide (54), 60" wide (60), 66" wide (66), 72" wide (72), 78" wide (78), 84" wide (84), 90" wide (90), or 96" wide (96)

- F painted extended architectural top cap to span 2 frames A
- G painted extended standard top cap to span 2 frames A
- H painted extended architectural top cap to span 2 frames in runs of 3 frames or more A
- J painted extended standard top cap to span 2 frames in runs of 3 frames or more A

Frame Top Screen *continued*

Step 5. Surface Finish

For painted architectural top cap (A), painted extended architectural top cap to span 2 frames (F), or painted extended architectural top cap to span 2 frames in runs of 3 frames or more (H)

TR	clear glass - 1/4" thick	A
5A	opal etched - 1/4" thick	A
NN	no glass- for customer's own glass	A
C3	clear glass - 3/8" thick	A
G3	opal glass - 3/8" thick	A
N3	no glass, for customer's own 3/8" thick glass	A

For painted standard top cap (P), painted extended standard top cap to span 2 frames (G), or painted extended standard top cap to span 2 frames in runs of 3 frames or more (I)

TR	clear glass - 1/4" thick
5A	opal etched - 1/4" thick
NN	no glass- for customer's own glass

Prices for Steps 1-5.

	ATR	A5A	ANN	AC3	AG3	AN3
FT114. 07 18	\$287	346	207	353	442	207
24	\$306	381	224	383	478	224
30	\$333	419	251	416	523	251
36	\$363	466	276	456	581	276
42	\$397	512	303	496	640	303
48	\$433	560	339	541	698	339
11 18	\$317	387	207	397	489	207
24	\$334	420	224	420	526	224
30	\$360	459	251	449	574	251
36	\$390	513	276	489	640	276
42	\$425	574	303	533	717	303
48	\$461	629	339	581	787	339
15 18	\$346	416	207	424	515	207
24	\$360	451	224	452	567	224
30	\$387	496	251	486	625	251
36	\$418	560	276	523	698	276
42	\$452	629	303	567	787	303
48	\$488	716	339	611	896	339

	PTR	P5A	PNN	FTR	F5A	FNN
FT114. 07 18	\$247	310	159	—	—	—
24	\$258	333	174	—	—	—
30	\$276	363	195	—	—	—
36	\$300	402	215	—	—	—
42	\$328	442	234	—	—	—
48	\$356	482	261	—	—	—
54	—	—	—	\$440	595	374
60	—	—	—	\$482	662	406
66	—	—	—	\$523	697	433
72	—	—	—	\$569	733	451
78	—	—	—	\$618	778	478
84	—	—	—	\$663	831	497
90	—	—	—	\$725	882	530
96	—	—	—	\$778	922	554
11 18	\$265	342	159	—	—	—
24	\$285	372	174	—	—	—
30	\$305	402	195	—	—	—
36	\$328	450	215	—	—	—
42	\$356	504	234	—	—	—
48	\$383	551	261	—	—	—
54	—	—	—	\$466	676	374
60	—	—	—	\$508	744	406
66	—	—	—	\$548	800	433
72	—	—	—	\$595	852	451
78	—	—	—	\$642	896	478
84	—	—	—	\$689	969	497
90	—	—	—	\$751	1024	530
96	—	—	—	\$802	1083	554
15 18	\$295	372	159	—	—	—
24	\$313	402	174	—	—	—
30	\$333	442	195	—	—	—
36	\$356	496	215	—	—	—
42	\$383	560	234	—	—	—
48	\$411	638	261	—	—	—
54	—	—	—	\$502	764	374
60	—	—	—	\$541	840	406
66	—	—	—	\$584	918	433
72	—	—	—	\$634	977	451
78	—	—	—	\$686	1059	478
84	—	—	—	\$730	1117	497
90	—	—	—	\$791	1169	530
96	—	—	—	\$844	1216	554

	FC3	FG3	FN3	GTR	G5A	GNN
FT114. 07 54	\$551	745	374	362	517	296
60	\$604	827	406	396	577	319
66	\$656	872	433	430	605	341
72	\$711	917	451	469	634	351
78	\$772	972	478	510	672	370
84	\$827	1038	497	551	716	385
90	\$906	1102	530	595	753	399
96	\$972	1151	554	638	781	415
11 54	\$583	845	374	388	598	296
60	\$634	932	406	423	657	319
66	\$687	999	433	455	707	341
72	\$745	1069	451	495	753	351
78	\$803	1121	478	535	789	370
84	\$862	1214	497	577	856	385
90	\$938	1278	530	621	892	399
96	\$1003	1354	554	665	944	415
15 54	\$628	955	374	425	686	296
60	\$676	1048	406	455	753	319
66	\$731	1148	433	491	826	341
72	\$793	1221	451	535	878	351
78	\$859	1324	478	579	951	370
84	\$914	1396	497	618	1002	385
90	\$989	1464	530	660	1040	399
96	\$1055	1524	554	704	1076	415
	HTR	H5A	HNN	HC3	HG3	HN3
FT114. 07 54	\$440	595	374	551	745	374
60	\$482	662	406	604	827	406
66	\$523	697	433	656	872	433
72	\$569	733	451	711	917	451
78	\$618	778	478	772	972	478
84	\$663	831	497	827	1038	497
90	\$725	882	530	906	1102	530
96	\$778	922	554	972	1151	554
11 54	\$466	676	374	583	845	374
60	\$508	744	406	634	932	406
66	\$548	800	433	687	999	433
72	\$595	852	451	745	1069	451
78	\$642	896	478	803	1121	478
84	\$689	969	497	862	1214	497
90	\$751	1024	530	938	1278	530
96	\$802	1083	554	1003	1354	554

15 54	\$502	764	374	628	955	374
60	\$541	840	406	676	1048	406
66	\$584	918	433	731	1148	433
72	\$634	977	451	793	1221	451
78	\$686	1059	478	859	1324	478
84	\$730	1117	497	914	1396	497
90	\$791	1169	530	989	1464	530
96	\$844	1216	554	1055	1524	554
	JTR	J5A	JNN			
FT114. 07 54	\$362	517	296			
60	\$396	577	319			
66	\$430	605	341			
72	\$469	634	351			
78	\$510	672	370			
84	\$551	716	385			
90	\$595	753	399			
96	\$638	781	415			
11 54	\$388	598	296			
60	\$423	657	319			
66	\$455	707	341			
72	\$495	753	351			
78	\$535	789	370			
84	\$577	856	385			
90	\$621	892	399			
96	\$665	944	415			
15 54	\$425	686	296			
60	\$455	753	319			
66	\$491	826	341			
72	\$535	878	351			
78	\$579	951	370			
84	\$618	1002	385			
90	\$660	1040	399			
96	\$704	1076	415			

Step 6. Top Cap Finish

8Q	folkstone grey	+\$0
91	white	+\$0
98	studio white	+\$0
CL	cool grey neutral	+\$0
G1	graphite	+\$0
WL	sandstone	+\$0
WN	warm grey neutral	+\$0
CN	metallic champagne	+\$0
EH	metallic bronze	+\$0
MS	metallic silver	+\$0

Pari Screen, Frame Top

FT355.

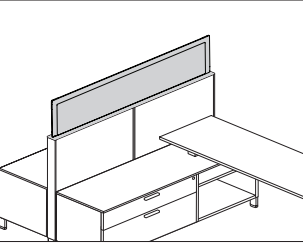

Product Information

Description

This tackable fabric screen attaches to the top of a Canvas frame (or frames) to provide boundary with a tackable surface. Bayonets extend through the top cap for attachment, which allows the screen to sit cleanly on the top cap. Frame top cap and attachment hardware included.

Notes

Specify width of screen to match the width of 1 frame, or the combined width of 2 frames.

24"- to 48"-wide frame top screens can only span 1 frame. 54"-wide and wider can span 2 frames.

Screen comes with metal alignment piece that attaches into the top of 2 screens to align them along a run.

15"-high screen will align with top of upmount unit (FT415.), but not with other frame top screens.

Cables cannot be routed along top channel of frame where screen is attached.

Screen cannot attach to top of thin-profile stacking window (FT187.)

Screen cannot be used in in-line, frame-to-frame, change-of-height applications.

Screen cannot be used on frames with veneer finished ends.

Screen cannot be used next to connector-attached power poles (FT143., FT14A.).

A frame with a Pari screen, frame top (FT355.) cannot be placed off module to a spine wall frame.

Options (F) and (G) are for 54"-wide and wider top cap to span the combined width of 2 adjacent frames placed between 2 universal connectors or a universal connector and a finished end.

Options (H) and (J) are for 54"-wide and wider top cap to span the combined width of 2 adjacent frames in runs of 3 frames or more.

Order screen attached marker board (FD125.) separately.

Screen accepts Customer's Own Material (COM). Yardage is estimated for nondirectional 54"-wide fabrics.

For vertical fabric direction (T):

Height—Yardage

11—1.04

15—1.30

For horizontal fabric direction (R):

Width—Yardage

24—0.95

30—1.14

36—1.32

42—1.51

48—1.71

54—1.90

60—2.07

66—2.27

72—2.46

For information on multiple quantities or directional fabrics, contact COM Department. See Order Information in Appendices.

Dimensions

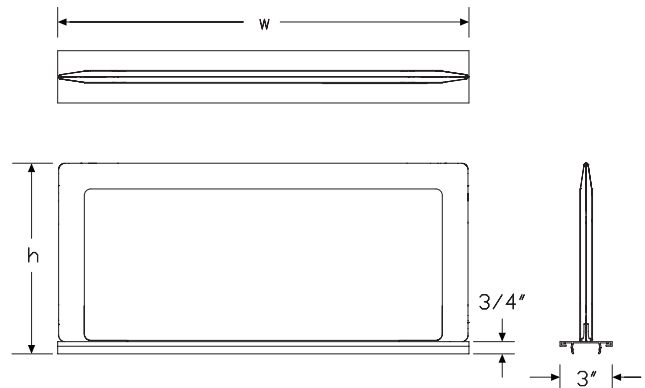

Specification Information

Step 1.

FT355. A

Step 2. Height

11 11" high A
15 15" high A

Step 3. Width

24 24" wide A
30 30" wide A
36 36" wide A
42 42" wide A
48 48" wide A
54 54" wide A
60 60" wide A
66 66" wide A
72 72" wide A

Step 4. Surface Material

For 24" wide (24), 30" wide (30), 36" wide (36), 42" wide (42), or 48" wide (48)

R tackable fabric, horizontal A
T tackable fabric A

For 54" wide (54), 60" wide (60), 66" wide (66), or 72" wide (72)

R tackable fabric, horizontal A

Step 5. Top Cap Material

For 24" wide (24), 30" wide (30), 36" wide (36), 42" wide (42), or 48" wide (48)

A painted architectural top cap A
P painted standard top cap A

For 54" wide (54), 60" wide (60), 66" wide (66), or 72" wide (72)

F painted extended architectural top cap to span 2 frames A
G painted extended standard top cap to span 2 frames A
H painted extended architectural top cap to span 2 frames in runs of 3 frames or more A
J painted extended standard top cap to span 2 frames in runs of 3 frames or more A

Prices for Steps 1-5.

		RA	RF	RG	RP	RH	RJ
FT355.	11 24	\$740	—	—	705	—	—
	30	\$780	—	—	738	—	—
	36	\$820	—	—	772	—	—
	42	\$860	—	—	805	—	—
	48	\$900	—	—	838	—	—
	54	—	\$940	872	—	940	872
	60	—	\$980	905	—	980	905
	66	—	\$1005	928	—	1005	928
	72	—	\$1030	950	—	1030	950
	15 24	\$755	—	—	720	—	—
30	\$800	—	—	758	—	—	
36	\$855	—	—	807	—	—	
42	\$905	—	—	850	—	—	
48	\$945	—	—	878	—	—	
54	—	\$980	912	—	980	912	
60	—	\$1035	965	—	1035	965	
66	—	\$1090	1013	—	1090	1013	
72	—	\$1150	1070	—	1150	1070	

		TA	TP
FT355.	11 24	\$740	705
	30	\$780	738
	36	\$820	772
	42	\$860	805
	48	\$900	838
	15 24	\$755	720
	30	\$800	758
	36	\$855	807
	42	\$905	850
	48	\$945	878

Step 6. Top Cap Finish

8Q	folkstone grey A	+\$0
91	white A	+\$0
98	studio white A	+\$0
CL	cool grey neutral A	+\$0
G1	graphite A	+\$0
WL	sandstone A	+\$0
WN	warm grey neutral A	+\$0
CN	metallic champagne A	+\$0
EH	metallic bronze A	+\$0
MS	metallic silver A	+\$0

Pari Screen, Frame Top *continued*

Step 7. Fabric

For 24" wide (24) or 30" wide (30)

Price Category 1	+\$0
Price Category 2	+\$15
Price Category 3	+\$35
Price Category 4	+\$61
Price Category E	+\$216

For 36" wide (36), 42" wide (42), or 48" wide (48)

Price Category 1	+\$0
Price Category 2	+\$17
Price Category 3	+\$40
Price Category 4	+\$70
Price Category E	+\$216

For 54" wide (54) or 60" wide (60)

Price Category 1	+\$0
Price Category 2	+\$25
Price Category 3	+\$60
Price Category 4	+\$104

For 66" wide (66) or 72" wide (72)

Price Category 1	+\$0
Price Category 2	+\$30
Price Category 3	+\$71
Price Category 4	+\$124
Price Category E	+\$216

Single Sided Base Cover Kit

FT963.

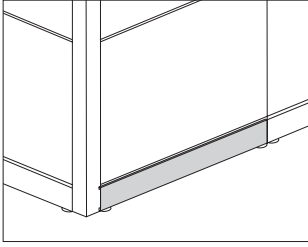

Canvas Office Landscape® Walls

Product Information	
Description	This base cover attaches to one side of a frame (or frames) with no base covers (FT110.xxxX) to enclose the base when a to-the-floor tile is used on the opposite side. Attachment hardware included.
Notes	Match width of base cover to width of 1 frame, or the combined width of 2 frames. Specify no attachment clips option (NN) when retrofitting the single-sided base cover kit to an existing frame with base.
Dimensions	

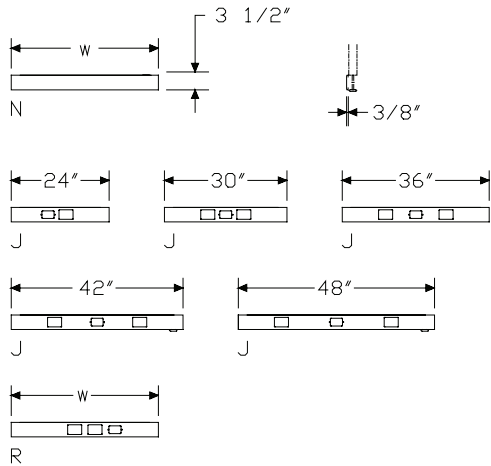

Specification Information

Step 1.

FT963.

Step 2. Width

18	18" wide
24	24" wide
30	30" wide
36	36" wide
42	42" wide
48	48" wide
54	54" wide
60	60" wide
66	66" wide
72	72" wide
78	78" wide
84	84" wide
90	90" wide
96	96" wide

Step 3. Base Option

For 24" wide (24), 30" wide (30), 36" wide (36), 42" wide (42), or 48" wide (48)

N	no knockouts
J	power/data knockouts
R	power/data knockouts (meets Chicago electrical code requirements)

For 18" wide (18), 54" wide (54), 60" wide (60), 66" wide (66), 72" wide (72), 78" wide (78), 84" wide (84), 90" wide (90), or 96" wide (96)

N	no knockouts
----------	--------------

Step 4. Attachment

For 18" wide (18), 24" wide (24), 30" wide (30), 36" wide (36), 42" wide (42), or 48" wide (48)

TF	to-the-floor tiles on 1 side
NN	no attachment clips

For 54" wide (54), 60" wide (60), 66" wide (66), 72" wide (72), 78" wide (78), 84" wide (84), 90" wide (90), or 96" wide (96)

TF	to-the-floor tiles on 1 side
BC	base covers on 2 sides
NN	no attachment clips

Single Sided Base Cover Kit *continued*

Prices for Steps 1-4.

	TF	BC	NN
FT963. 18 N	\$37	—	24
24 N	\$39	—	29
J	\$39	—	29
R	\$39	—	29
30 N	\$41	—	34
J	\$41	—	34
R	\$41	—	34
36 N	\$44	—	39
J	\$44	—	39
R	\$44	—	39
42 N	\$48	—	45
J	\$48	—	45
R	\$48	—	45
48 N	\$53	—	50
J	\$53	—	50
R	\$53	—	50
54 N	\$70	70	65
60 N	\$76	76	70
66 N	\$81	81	76
72 N	\$85	85	80
78 N	\$89	89	84
84 N	\$94	94	87
90 N	\$99	99	90
96 N	\$106	106	93

Step 5. Surface Finish

8Q	folkstone grey <input type="checkbox"/> A	+\$0
98	studio white <input type="checkbox"/> A	+\$0
WL	sandstone <input type="checkbox"/> A	+\$0

Bright Sand Texture Paint

91	white	+\$0
CL	cool grey neutral	+\$0
G1	graphite	+\$0
WN	warm grey neutral	+\$0

Metallic Paint

CN	metallic champagne	+\$0
EH	metallic bronze	+\$0
MS	metallic silver	+\$0

Base Cover Retrofit Kit

FT163.

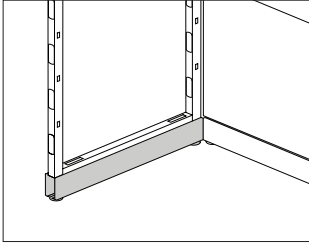

Canvas Office Landscape® Walls

Product Information

Description

This kit converts a frame with an open base to a frame with a base cover. Attachment hardware and glides are included.

Notes

Specify 1 kit per frame (2 base covers are included).

For powered base, order base power harness (FT150.) separately.

Dimensions

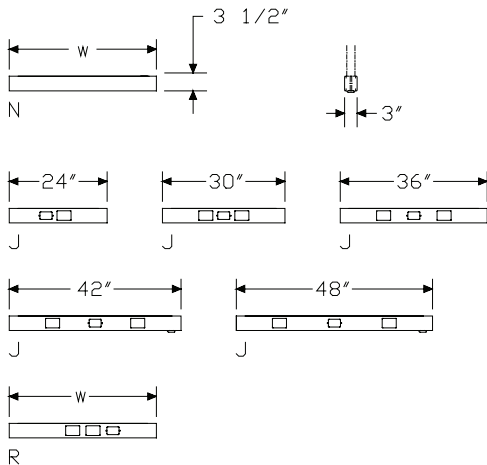

Specification Information

Step 1.

FT163.

Step 2. Width

- 18** 18" wide
- 24** 24" wide
- 30** 30" wide
- 36** 36" wide
- 42** 42" wide
- 48** 48" wide

Step 3. Base Option

For 18" wide (18)

- N** no knockouts

For 24" wide (24), 30" wide (30), 36" wide (36), 42" wide (42), or 48" wide (48)

- N** no knockouts
- J** power/data knockouts
- R** power/data knockouts (meets Chicago electrical code requirements)

Prices for Steps 1-3.

	N	J	R
FT163. 18	\$62	—	—
24	\$64	64	64
30	\$67	67	67
36	\$70	70	70
42	\$74	74	74
48	\$77	77	77

Step 4. Finish

- 8Q** folkstone grey **A** +\$0
- 98** studio white **A** +\$0
- WL** sandstone **A** +\$0

Bright Sand Texture Paint

- 91** white +\$0
- CL** cool grey neutral +\$0
- G1** graphite +\$0
- WN** warm grey neutral +\$0

Base Cover Retrofit Kit *continued*

Metallic Paint		
CN	metallic champagne	+\$0
EH	metallic bronze	+\$0
MS	metallic silver	+\$0

Open Base Retrofit Kit, Tapered Foot FT164.

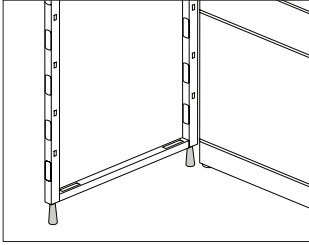

Canvas Office Landscape® Walls

Product Information

Description

This kit converts a frame with a base cover to an open base frame with tapered feet. Attachment hardware and glides are included.

Notes

Specify 1 kit per frame.

Dimensions

Specification Information

Step 1.

FT164.

\$33

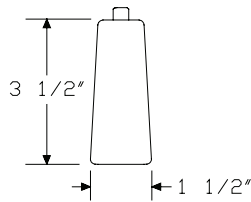

Retrofit Base Cover for Power Entry

FT162.

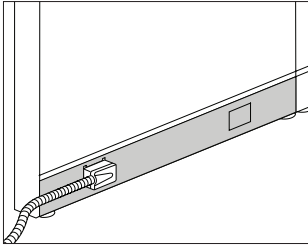

Product Information

Description

This base cover replaces an existing frame base cover. It allows for easier installation of an external direct connect power entry.

Notes

Specify 1 retrofit base cover per frame.

Order external direct connect power entry (FT140.) separately.

Covers are included for unused openings.

Dimensions

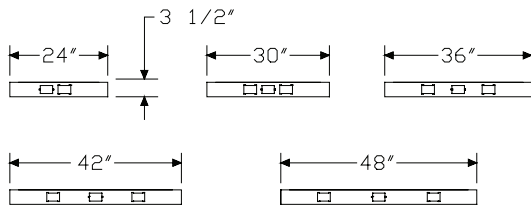

Specification Information

Step 1.

FT162.

Step 2. Width

24	24" wide
30	30" wide
36	36" wide
42	42" wide
48	48" wide

Prices for Steps 1-2.

FT162. 24	\$37
30	\$41
36	\$47
42	\$50
48	\$53

Step 3. Finish

8Q	folkstone grey <input type="checkbox"/> A	+\$0
98	studio white <input type="checkbox"/> A	+\$0
WL	sandstone <input type="checkbox"/> A	+\$0

Bright Sand Texture Paint

91	white	+\$0
CL	cool grey neutral	+\$0
G1	graphite	+\$0
WN	warm grey neutral	+\$0

Metallic Paint

CN	metallic champagne	+\$0
EH	metallic bronze	+\$0
MS	metallic silver	+\$0

Frame-to-Frame Connection
Hardware

FT128.

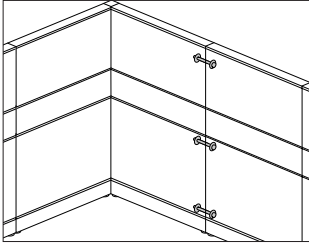

Canvas Office Landscape® Walls

Product Information

Description

This hardware connects 2 frames of equal or unequal heights in a straight line. Light seal is included; finish is black.

Notes

When connecting frames of unequal heights, specify height to match lower frame.

35", 42"- and 46"-high hardware includes 2 bolts; 53", 57", 68"- and 79"-high hardware includes 3 bolts.

Dimensions

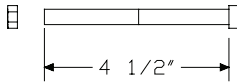
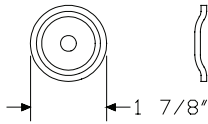

Specification Information

Step 1.

FT128.

Step 2. Frame Height

35	35" high
42	42" high
46	46" high
53	53" high
57	57" high
68	68" high
79	79" high

Prices for Steps 1-2.

FT128. 35	\$23
42	\$24
46	\$24
53	\$30
57	\$32
68	\$33
79	\$34

90° Universal Connector

FT121.

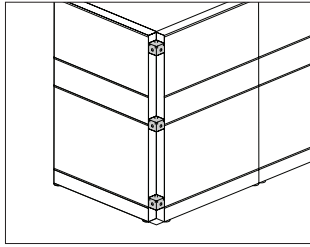

Product Information

Description

This connector joins 2, 3, or 4 frames of equal or unequal heights at a 90° angle. Attachment hardware and light seal included. Light seal finish is black.

Notes

For 53"-high frames and higher, specify 57"-high 90° universal connector (FT121_57).

For 2-way connections, specify connector to match height of lower connecting frame. For 3-way and 4-way connections, specify connector to match height of higher connecting frame.

Order the following products separately:

- 90° connector cover (FT123.) or 90° architectural connector cover (FT12B.)
- 90° connector top cap (FT126.) or 90° architectural connector top cap (FT12A.)

To pass power in a straight line through connector, order power harness extender (FT151.) separately.

FT121_46 includes 2 blocks for frames 46"-high and lower; FT121_57 includes 3 blocks for frames 53"-high and higher.

4-way connector kit includes enough hardware to complete a 2-way, 3-way, or 4-way 90° connection.

Additional hardware and light seals are available through Service Parts to convert connectors to different configurations.

Dimensions

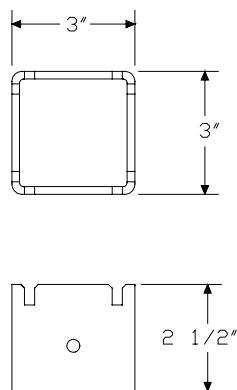

Specification Information

Step 1.

FT121.

Step 2. Configuration

- 2** 2 way, 90° or 180°
- 3** 3 way
- 4** 4 way

Step 3. Frame Height

- 46** for 46"-high frames and lower
- 57** for 53"-high frames and higher

Prices for Steps 1-3.

	46	57
FT121. 2	\$60	94
3	\$71	106
4	\$83	118

120° Universal Connector

FT131.

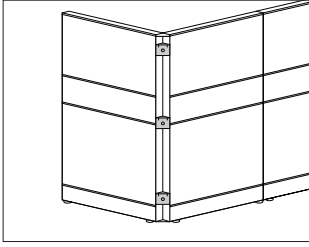

Canvas Office Landscape® Walls

Product Information

Description

This connector joins 2 or 3 frames of equal or unequal heights at a 120° angle. Attachment hardware and light seal included. Light seal finish is black.

Notes

For 53"-high frames and higher, specify 57"-high 120° universal connector (FT131_57).

For 2-way connections, specify connector to match height of lower connecting frame. For 3-way connections, specify connector to match height of higher connecting frame.

Order 120° connector cover (FT133.) and 120° connector top cap (FT136.) separately.

FT131_46 includes 2 blocks for frames 46"-high and lower; FT131_57 includes 3 blocks for frames 53"-high and higher.

3-way connector kit includes enough hardware and light seals to complete a 2-way or 3-way 120° connection.

Additional hardware and light seals are available through Service Parts to convert connectors to different configurations.

Dimensions

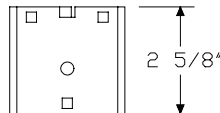
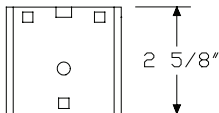
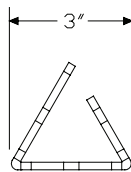
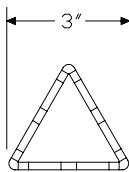

Specification Information

Step 1.

FT131.

Step 2. Configuration

2	2 way
3	3 way

Step 3. Frame Height

46	for 46"-high frames and lower
57	for 53"-high frames and higher

Prices for Steps 1-3.

	46	57
FT131. 2	\$96	147
3	\$107	160

Off-Module 90° Connector Kit

FT127.

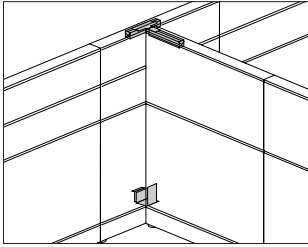

Product Information

Description

This hardware kit connects a return frame to a spine wall frame at 90° in an off-module application. It works with open base frames, frames with architectural feet, and frames with base covers.

Notes

Option A is used with frames with standard top caps to connect an equal-height return frame anywhere along a spine wall frame when an off-module upper tile is not used. Option B is used with frames with standard or architectural top caps and connects an equal- or lower-height return frame to the top of an off-module upper tile in 1" intervals. Use option B when:

- Architectural frame top caps are used.
- Return frame is the same height and the spine wall frame has an off-module tile with storage at the top. Specify off-module upper tile (FT188.) separately.
- Return frame is a lower change-of-height (COH). Specify off-module change-of-height support rail (FT166.) and off-module upper tile (FT188.) separately.

When using option B, top of off-module upper tile must match height of return frame.

Off-module return frame cannot attach within 2" of spine wall frame ends on frames with a base or open base with tapered foot, or 4" from the end of a frame with architectural foot.

Power/data cannot be routed from spine wall frame to off-module return frame.

Connector kit cannot be used for off module placement to a spine wall of a frame with any of the following products:

- Upmount screen (FT113.)
- Frame top screen (FT114.)
- Thin profile stacking window (FT187.)
- Pari screen, frame top (FT355.)

Dimensions

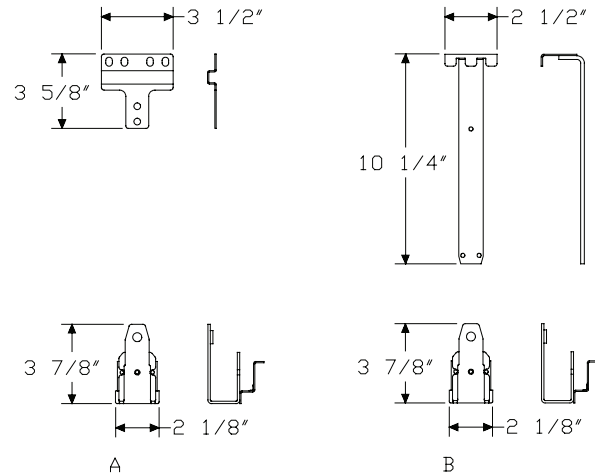

Off-Module 90° Connector Kit

continued

Canvas Office Landscape® Walls

Specification Information

Step 1.

FT127.

Step 2. Application

A for equal-height frames (no off-module tile)

B for off-module tile (equal or COH frames)

Prices for Steps 1-2.

FT127. A \$253

B \$218

Off-Module Change-of-Height Support Rail

FT166.

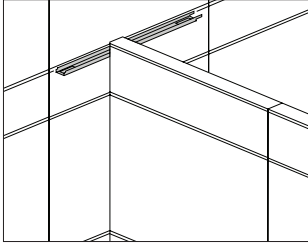

Product Information

Description

This rail attaches to the interior of a standard or stacking frame, or at the intersection of a base frame and stacking frame, to provide reinforcement for an off-module tile on 1 or both sides. It is used when connecting a return frame of lower height in an off-module application, or when attaching overhead storage in the middle location of the frame in an off-module application.

Notes

Specify off-module upper tile (FT188.) separately.

Location of support rail and top of off-module upper tile must match height of return frame.

Use middle frame position option (A) when top of off-module tile will be below the top of a standard frame or 22" high stacking frame.

Use base frame/stacking frame intersection option (B) when top of off-module tile will be at the top of a base frame with a stacking frame above.

Rail cannot be used for off module placement to a spine wall of a frame with any of the following products:

- Upmount screen (FT113.)
- Frame top screen (FT114.)
- Thin profile stacking window (FT187.)
- Pari screen, frame top (FT355.)

Dimensions

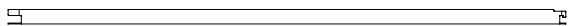
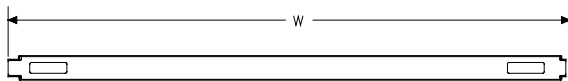

Specification Information

Step 1.

FT166.

Step 2. Width/Application

24A	24" wide, middle frame location
30A	30" wide, middle frame location
36A	36" wide, middle frame location
42A	42" wide, middle frame location
48A	48" wide, middle frame location
00B	base frame/stacking frame intersection

Prices for Steps 1-2.

FT166. 24A	\$66
30A	\$74
36A	\$84
42A	\$89
48A	\$93
00B	\$29

90° Universal Stacking Connector FT122.

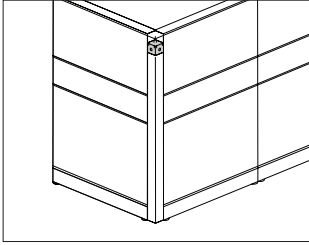

Canvas Office Landscape® Walls

Product Information

Description
 This stacking connector joins 1, 2, 3, or 4 stacking frames of equal or unequal heights at a 90° angle. It is used to attach an 11"- or 22"-high stacking frame to an adjacent frame or frames. Attachment hardware, light seal, and 1 block are included. Block has 1 removable side for cable routing capability.

Notes

The total connector height cannot exceed 90".
 Order the following products separately:
 • 90° connector cover (FT123.) or 90° architectural connector cover (FT12B.)
 • 90° connector top cap (FT126.) or 90° architectural connector top cap (FT12A.)
 Specify height of connector cover as combined height of connector and stacking connector.
 To extend height of adjacent frames, order stacking frame (FT111.) separately.
 To pass power in a straight line through connector, order power harness extender (FT151.) separately.
 4-way connector kit includes enough hardware to complete a 2-way, 3-way, or 4-way 90° connection.
 Additional hardware and light seals are available through Service Parts to convert connectors to different configurations.

Dimensions

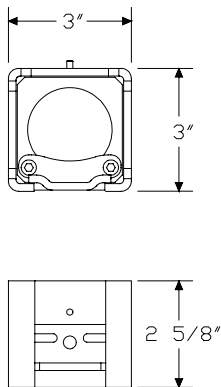

Specification Information

Step 1.

FT122.

Step 2. Configuration

2	2 way, 90° or 180°
3	3 way
4	4 way

Prices for Steps 1-2.

FT122. 2	\$39
3	\$47
4	\$53

120° Universal Stacking Connector

FT132.

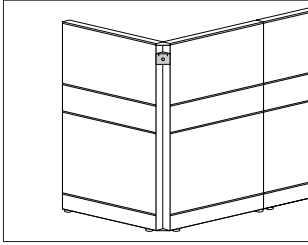

Product Information

Description

This stacking connector joins a stacking frame to another frame(s) at a 2- or 3-way 120° connector. It is used to attach an 11"- or 22"-high stacking frame to an adjacent frame(s) that is the same height or higher than the stacked frame. The total frame height cannot exceed 90". Attachment hardware, light seal, and 1 top block are included. Light seal finish is black.

Notes

Order 120° connector top cap (FT136.) and 120° connector cover (FT133.) separately. Specify height of connector cover as combined height of connector and stacking connector.

To extend height of adjacent frames, order stacking frame (FT111.) separately.

3-way connector kit includes enough hardware and light seals to complete a 2-way or 3-way 120° connection.

Additional hardware and light seals are available through Service Parts to convert connectors to different configurations.

Dimensions

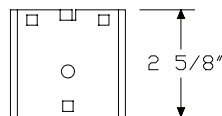
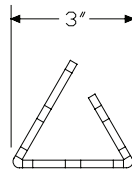

Specification Information

Step 1.

FT132.

Step 2. Configuration

2	2 way
3	3 way

Prices for Steps 1-2.

FT132. 2	\$62
3	\$67

90° Connector Cover

FT123.

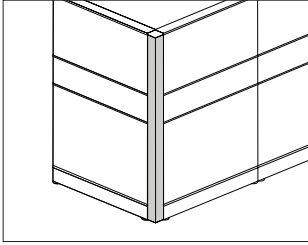

Canvas Office Landscape® Walls

Product Information

Description
This connector cover attaches to a connector or stacking connector of equal height. It has a painted or veneer surface. Attachment hardware included.

Notes

Specify connector cover to match height of frame and number of connector sides that are exposed.
For change-of-height application, specify connector cover height to match exposed height of lower frames; specify a separate cover(s) to match the exposed height of the higher frame(s).
7", 11", 15", 18", 22", 26", and 33"-high connector covers are only used in change-of-height applications. 7", 15", 18", and 26"-high connector covers are intended for use with 42" and 53"-high frames.
Light seals are included with change-of-height connectors only.
When 35"-high or higher 1-sided covers are used at a 2-way 180° connection, light seals are needed for at least 1 connector cover. Specify Service Part U1B3THG separately.
For application information, see Connector Cover Matrix in Canvas Planning Guide.

Dimensions

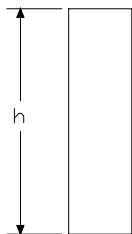
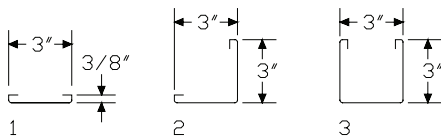

Specification Information

Step 1.

FT123.

Step 2. Configuration

- 1 1 side covered
- 2 2 sides covered
- 3 3 sides covered

Step 3. Height

For 1 side covered (1) or 2 sides covered (2)

- 07 7" high (for 42" and 53" high frames only)
- 11 11" high
- 15 15" high (for use with 42" or 53" high frames)
- 18 18" high (for use with 42" or 53" high frames)
- 22 22" high
- 26 26" high (for use with 42" or 53" high frames)
- 33 33" high
- 35 35" high
- 42 42" high
- 46 46" high
- 53 53" high
- 57 57" high
- 64 64" high
- 68 68" high
- 79 79" high
- 90 90" high

For 3 sides covered (3)

- 07 7" high (for 42" and 53" high frames only)
- 11 11" high
- 15 15" high (for use with 42" or 53" high frames)
- 18 18" high (for use with 42" or 53" high frames)
- 22 22" high
- 26 26" high (for use with 42" or 53" high frames)
- 33 33" high

Step 4. Base Option

For 7" high (for 42" and 53" high frames only) (07), 11" high (11), 15" high (for use with 42" or 53" high frames) (15), 18" high (for use with 42" or 53" high frames) (18), 22" high (22), 26" high (for use with 42" or 53" high frames) (26), or 33" high (33)

- N no base

For 35" high (35), 42" high (42), 46" high (46), 53" high (53), 57" high (57), 64" high (64), 68" high (68), 79" high (79), or 90" high (90)

- A** open base, tapered foot
- B** base cover/to-the-floor tile

Step 5. Surface Material

- P** painted
- W** veneer A

Prices for Steps 1-5.

		AP	AW	NP	NW	BP	BW
FT123. 1	07	—	—	\$38	156	—	—
	11	—	—	\$39	167	—	—
	15	—	—	\$41	182	—	—
	18	—	—	\$45	194	—	—
	22	—	—	\$47	206	—	—
	26	—	—	\$49	222	—	—
	33	—	—	\$53	246	—	—
	35	\$36	149	—	—	38	161
	42	\$38	171	—	—	41	182
	46	\$41	184	—	—	44	196
53	\$44	203	—	—	46	215	
57	\$46	222	—	—	49	234	
64	\$49	240	—	—	51	251	
68	\$51	258	—	—	53	269	
79	\$55	294	—	—	57	306	
90	\$59	332	—	—	61	343	
2	07	—	—	\$45	167	—	—
	11	—	—	\$47	185	—	—
	15	—	—	\$49	216	—	—
	18	—	—	\$52	239	—	—
	22	—	—	\$53	259	—	—
	26	—	—	\$55	289	—	—
	33	—	—	\$59	333	—	—
	35	\$49	223	—	—	51	238
	42	\$52	257	—	—	54	271
	46	\$54	281	—	—	56	296
53	\$57	309	—	—	59	325	
57	\$59	339	—	—	61	353	
64	\$62	368	—	—	65	383	
68	\$65	396	—	—	67	411	
79	\$71	454	—	—	73	469	
90	\$76	511	—	—	79	527	

3	07	—	—	\$62	213	—	—
	11	—	—	\$65	227	—	—
	15	—	—	\$68	261	—	—
	18	—	—	\$70	292	—	—
	22	—	—	\$71	310	—	—
	26	—	—	\$74	344	—	—
	33	—	—	\$77	394	—	—

Step 6. Surface Finish

Bright Sand Texture Paint

For painted (P)

91	white	+\$0
CL	cool grey neutral	+\$0
G1	graphite	+\$0
WN	warm grey neutral	+\$0

For painted (P)

8Q	folkstone grey	+\$0
98	studio white	+\$0
WL	sandstone	+\$0

Metallic Paint

For painted (P)

CN	metallic champagne	+\$0
EH	metallic bronze	+\$0
MS	metallic silver	+\$0

Wood Veneer

For veneer (W)

2U	light brown walnut A	+\$0
40	dark brown walnut	+\$0
ED	aged cherry A	+\$0
EK	medium red walnut	+\$0
EW	medium matte walnut	+\$0
ET	clear on ash A	+\$0
EU	oak on ash A	+\$0
EV	walnut on ash A	+\$0
UL	natural maple A	+\$0
UX	walnut on cherry A	+\$0

90° Connector Cover, Architectural

FT12B.

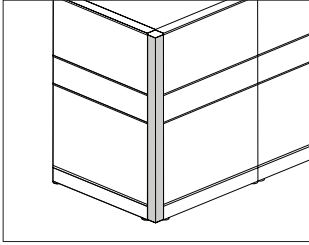

Canvas Office Landscape® Walls

Product Information

Description

This painted connector cover attaches to a connector or stacking connector of equal height. Attachment hardware included.

Notes

Specify connector cover to match overall height of frame(s) and number of connector sides that are exposed.

Order 90° connector top cap, architectural (FT12A.) separately.

For change-of-height application, specify connector cover height to match exposed height of lower frames; specify a separate cover(s) to match the exposed height of the higher frame(s).

7", 11", 15", 18", 22", 26", and 33"-high connector covers are only used in change-of-height applications. 7", 15", 18", and 26"-high connector covers are intended for use with 42" and 53"-high frames.

Light seals are included with change-of-height connectors only.

When 35"-high or higher 1-sided covers are used at a 2-way 180° connection, light seals are needed for at least 1 connector cover. Specify Service Part U1B3THG separately.

Dimensions

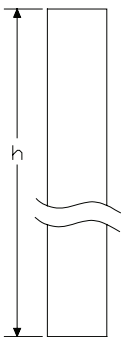
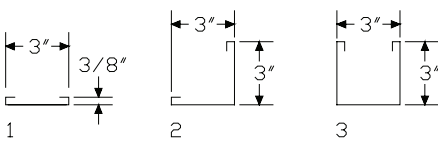

Specification Information

Step 1.

FT12B.

Step 2. Configuration

- | | |
|----------|-----------------|
| 1 | 1 side covered |
| 2 | 2 sides covered |
| 3 | 3 sides covered |

Step 3. Height

For 1 side covered (1) or 2 sides covered (2)

- | | |
|-----------|--|
| 07 | 7" high (for 42" and 53" high frames only) |
| 11 | 11" high |
| 15 | 15" high (for use with 42" or 53" high frames) |
| 18 | 18" high (for use with 42" or 53" high frames) |
| 22 | 22" high |
| 26 | 26" high (for use with 42" or 53" high frames) |
| 33 | 33" high |
| 35 | 35" high |
| 42 | 42" high |
| 46 | 46" high |
| 53 | 53" high |
| 57 | 57" high |
| 64 | 64" high |
| 68 | 68" high |
| 79 | 79" high |
| 90 | 90" high |

For 3 sides covered (3)

- | | |
|-----------|--|
| 07 | 7" high (for 42" and 53" high frames only) |
| 11 | 11" high |
| 15 | 15" high (for use with 42" or 53" high frames) |
| 18 | 18" high (for use with 42" or 53" high frames) |
| 22 | 22" high |
| 26 | 26" high (for use with 42" or 53" high frames) |
| 33 | 33" high |

Step 4. Base Option

For 7" high (for 42" and 53" high frames only) (07), 11" high (11), 15" high (for use with 42" or 53" high frames) (15), 18" high (for use with 42" or 53" high frames) (18), 22" high (22), 26" high (for use with 42" or 53" high frames) (26), or 33" high (33)

- | | |
|----------|---------|
| N | no base |
|----------|---------|

90° Connector Cover,
Architectural *continued*

For 35" high (35), 42" high (42), 46" high (46), 53" high (53), 57" high (57), 64" high (64), 68" high (68), 79" high (79), or 90" high (90)

- A** open base / architectural foot
- B** base cover / floor-length tiles

Step 5. Surface Material

- P** painted

Prices for Steps 1-5.

		AP	NP	BP
FT12B. 1	07	—	\$54	—
	11	—	\$56	—
	15	—	\$59	—
	18	—	\$61	—
	22	—	\$62	—
	26	—	\$67	—
	33	—	\$70	—
	35	\$70	—	73
	42	\$73	—	77
	46	\$77	—	81
	53	\$82	—	84
	57	\$84	—	88
	64	\$89	—	93
	68	\$91	—	95
	79	\$98	—	101
	90	\$106	—	111
2	07	—	\$69	—
	11	—	\$71	—
	15	—	\$74	—
	18	—	\$76	—
	22	—	\$78	—
	26	—	\$81	—
	33	—	\$84	—
	35	\$84	—	88
	42	\$88	—	91
	46	\$91	—	94
	53	\$94	—	97
	57	\$97	—	100
	64	\$101	—	106
	68	\$105	—	108
	79	\$112	—	116
	90	\$119	—	122

3	07	—	\$79	—
	11	—	\$81	—
	15	—	\$84	—
	18	—	\$86	—
	22	—	\$88	—
	26	—	\$91	—
	33	—	\$94	—

Step 6. Surface Finish

8Q	folkstone grey	+\$0
98	studio white	+\$0
WL	sandstone	+\$0

Bright Sand Texture Paint

91	white	+\$0
CL	cool grey neutral	+\$0
G1	graphite	+\$0
WN	warm grey neutral	+\$0

Metallic Paint

CN	metallic champagne	+\$0
EH	metallic bronze	+\$0
MS	metallic silver	+\$0

120° Connector Cover

FT133.

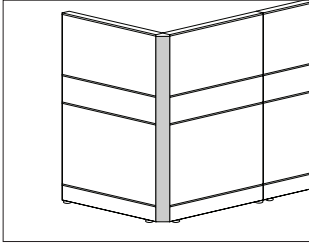

Canvas Office Landscape® Walls

Product Information

Description
This connector cover attaches to a 120° connector of equal height. It has a painted or veneer surface. Attachment hardware is included.

Notes
Specify connector cover(s) to match height of frame and match the number of connector sides that are exposed.

For change-of-height application, specify connector cover height to match exposed height of lower frames; specify a separate cover(s) to match the exposed height of the higher frame(s).
7", 11", 15", 18", 22", 26", and 33"-high connector covers are only used in change-of-height applications.

Light seals are included with change-of-height connectors only.
For application information, see Connector Cover Matrix in Canvas Planning Guide.

Dimensions

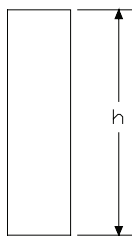
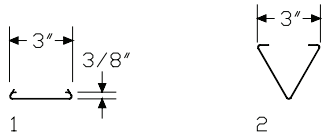

Specification Information

Step 1.

FT133.

Step 2. Configuration

- 1 1 side covered
- 2 2 sides covered

Step 3. Height

For 1 side covered (1)

- 07 7" high (for 42" and 53" high frames only)
- 11 11" high
- 15 15" high (for use with 42" or 53" high frames) A
- 18 18" high (for use with 42" or 53" high frames)
- 22 22" high
- 26 26" high (for use with 42" or 53" high frames) A
- 33 33" high
- 35 35" high
- 42 42" high
- 46 46" high
- 53 53" high
- 57 57" high
- 64 64" high
- 68 68" high
- 79 79" high
- 90 90" high

For 2 sides covered (2)

- 07 7" high (for 42" and 53" high frames only)
- 11 11" high
- 15 15" high (for use with 42" or 53" high frames) A
- 18 18" high (for use with 42" or 53" high frames)
- 22 22" high
- 26 26" high (for use with 42" or 53" high frames) A
- 33 33" high

Step 4. Base Option

For 7" high (for 42" and 53" high frames only) (07), 11" high (11), 15" high (for use with 42" or 53" high frames) (15), 18" high (for use with 42" or 53" high frames) (18), 22" high (22), 26" high (for use with 42" or 53" high frames) (26), or 33" high (33)

- N no base

120° Connector Cover *continued*

For 35" high (35), 42" high (42), 46" high (46), 53" high (53), 57" high (57), 64" high (64), 68" high (68), 79" high (79), or 90" high (90)

- A** open base, tapered foot
- B** base cover/to-the-floor tile

Step 5. Surface Material

- P** painted
- W** veneer A

Prices for Steps 1-5.

	AP	AW	NP	NW	BP	BW
FT133. 1 07	—	—	\$60	218	—	—
11	—	—	\$64	227	—	—
15	—	—	\$67	245	—	—
18	—	—	\$70	265	—	—
22	—	—	\$74	278	—	—
26	—	—	\$76	298	—	—
33	—	—	\$79	331	—	—
35	\$64	313	—	—	67	293
42	\$74	338	—	—	76	330
46	\$77	356	—	—	79	350
53	\$83	346	—	—	88	330
57	\$89	428	—	—	91	397
64	\$95	410	—	—	98	381
68	\$100	500	—	—	105	467
79	\$114	570	—	—	117	509
90	\$121	642	—	—	121	563
2 07	—	—	\$77	232	—	—
11	—	—	\$79	252	—	—
15	—	—	\$83	291	—	—
18	—	—	\$86	322	—	—
22	—	—	\$89	349	—	—
26	—	—	\$91	390	—	—
33	—	—	\$97	447	—	—

Step 6. Surface Finish

For painted (P)

- 8Q** folkstone grey +\$0
- 98** studio white +\$0
- WL** sandstone +\$0

Bright Sand Texture Paint

For painted (P)

- 91** white +\$0
- CL** cool grey neutral +\$0
- G1** graphite +\$0
- WN** warm grey neutral +\$0

Metallic Paint

For painted (P)

- CN** metallic champagne +\$0
- EH** metallic bronze +\$0
- MS** metallic silver +\$0

Wood Veneer

For veneer (W)

- 2U** light brown walnut A +\$0
- 40** dark brown walnut +\$0
- ED** aged cherry A +\$0
- EK** medium red walnut +\$0
- EW** medium matte walnut +\$0
- ET** clear on ash A +\$0
- EU** oak on ash A +\$0
- EV** walnut on ash A +\$0
- UL** natural maple A +\$0
- UX** walnut on cherry A +\$0

Connector Base Filler

FT165.

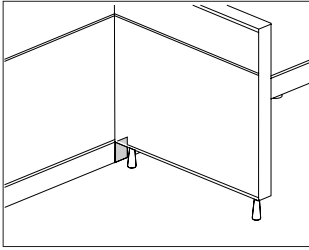

Canvas Office Landscape® Walls

Product Information

Description
This filler covers the space at the base of a connector when frames with base covers and frames with open bases are connected to one another. Attachment hardware is included.

Notes
For usage information, see Canvas Planning Guide.

Dimensions

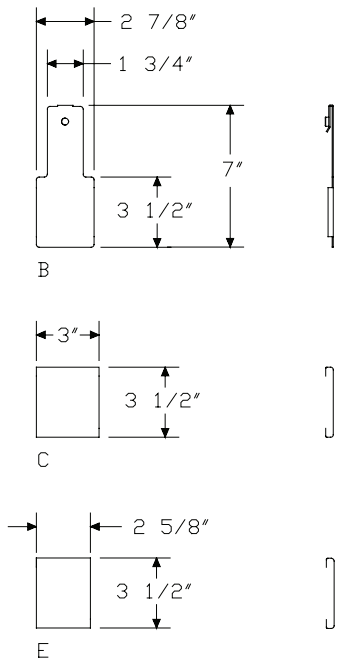

Specification Information

Step 1.

FT165.

Step 2. Usage

- B** for use at end of frame
- C** for use between 2 base covers
- E** for use between base cover and connector cover

Prices for Steps 1-2.

FT165. B	\$38
C	\$38
E	\$38

Step 3. Finish

Bright Sand Texture Paint

91	white	+\$0
CL	cool grey neutral	+\$0
G1	graphite	+\$0
WN	warm grey neutral	+\$0
8Q	folkstone grey	+\$0
98	studio white	+\$0
WL	sandstone	+\$0

Metallic Paint

CN	metallic champagne	+\$0
EH	metallic bronze	+\$0
MS	metallic silver	+\$0

Finished End

FT160.

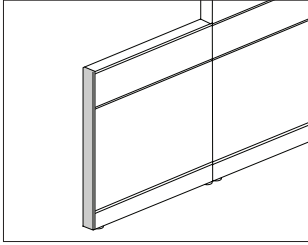

Product Information

Description

This cover finishes the exposed end of a single frame or covers the combined height of a frame and stacking frames. It has a painted or veneer surface and a black light seal. Attachment hardware is included.

Notes

Specify finished end height to match height of frame or combined height of frame and stacking frame(s). When using stacking frame at the end of a run, remove shorter finished end and add finished end for the total frame height.

Order frame top cap (FT112.) separately.

Dimensions

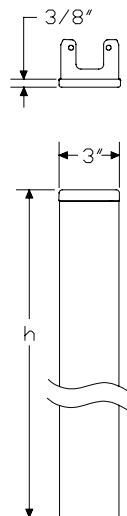

Specification Information

Step 1.

FT160.

Step 2. Height

35	35" high
42	42" high
46	46" high
53	53" high
57	57" high
64	64" high
68	68" high
79	79" high
90	90" high

Step 3. Base Option

A	open base, tapered foot
B	base cover/to-the-floor tile

Step 4. Surface Material

P	painted
W	veneer <input type="checkbox"/> A

Prices for Steps 1-4.

		P	W
FT160. 35	A	\$49	258
	B	\$54	270
42	A	\$52	280
	B	\$57	291
46	A	\$54	293
	B	\$59	306
53	A	\$57	320
	B	\$62	329
57	A	\$59	329
	B	\$64	340
64	A	\$62	351
	B	\$67	362
68	A	\$64	364
	B	\$69	375
79	A	\$69	398
	B	\$75	411
90	A	\$75	439
	B	\$80	450

Step 5. Surface Finish

For painted (P)

8Q	folkstone grey	+\$0
91	white	+\$0
98	studio white	+\$0
CL	cool grey neutral	+\$0
G1	graphite	+\$0
WL	sandstone	+\$0
WN	warm grey neutral	+\$0
CN	metallic champagne	+\$0
EH	metallic bronze	+\$0
MS	metallic silver	+\$0

Wood Veneer

For veneer (W)

2U	light brown walnut <input type="checkbox"/> A	+\$0
40	dark brown walnut	+\$0
ED	aged cherry <input type="checkbox"/> A	+\$0
EK	medium red walnut	+\$0
EW	medium matte walnut	+\$0
ET	clear on ash <input type="checkbox"/> A	+\$0
EU	oak on ash <input type="checkbox"/> A	+\$0
EV	walnut on ash <input type="checkbox"/> A	+\$0
UL	natural maple <input type="checkbox"/> A	+\$0
UX	walnut on cherry <input type="checkbox"/> A	+\$0

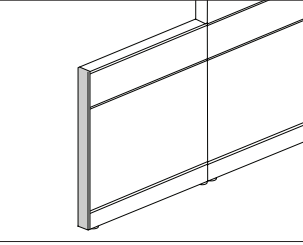

Product Information

Description

This cover finishes the exposed end of a single frame or covers the combined height of a frame and stacking frames. Light seal and attachment hardware included.

Notes

Specify finished end height to match height of frame or combined height of frame and stacking frame(s).
Order frame top cap, architectural (FT11A.) separately.

Dimensions

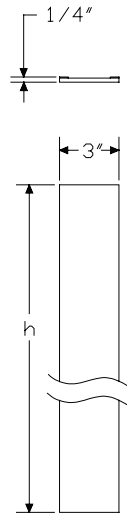

Specification Information

Step 1.

FT16A.

Step 2. Height

- 35 35" high
- 42 42" high
- 46 46" high
- 53 53" high
- 57 57" high
- 64 64" high
- 68 68" high
- 79 79" high
- 90 90" high

Step 3. Base Option

- A** open base / architectural foot
- B** base cover/to-the-floor tile

Step 4. Surface Material

- P** painted

Prices for Steps 1-4.

	P
FT16A. 35 A	\$193
B	\$202
42 A	\$202
B	\$212
46 A	\$212
B	\$219
53 A	\$221
B	\$230
57 A	\$227
B	\$235
64 A	\$238
B	\$241
68 A	\$244
B	\$251
79 A	\$261
B	\$269
90 A	\$276
B	\$285

Step 5. Surface Finish

- 8Q** folkstone grey +\$0
- 98** studio white +\$0
- WL** sandstone +\$0

Canvas Office Landscape® Walls

Bright Sand Texture Paint		
91	white	+\$0
CL	cool grey neutral	+\$0
G1	graphite	+\$0
WN	warm grey neutral	+\$0

Metallic Paint		
CN	metallic champagne	+\$0
EH	metallic bronze	+\$0
MS	metallic silver	+\$0

Finished End, Change of Height

FT161.

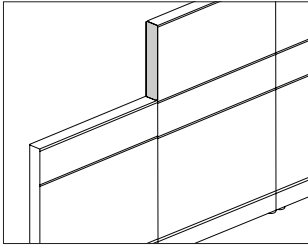

Product Information

Description

This cover finishes the exposed end of a frame when joining frames of unequal heights in a straight line. It has a painted or veneer surface and a black light seal. Attachment hardware is included.

Notes

Use change-of-height finished end for straight-line applications only (cannot use at connectors). For other applications, use connector covers (FT123.).

When routing cables through a finished end in a straight-line application, specify option (B).

When using stacking frame at the end of a run, remove shorter finished end and order finished end (FT160.) for the total frame height.

Dimensions

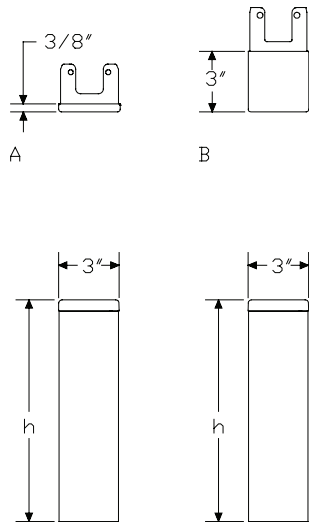

Specification Information

Step 1.

FT161.

Step 2. Height

- 07** 7" high (for 42" and 53" high frames only)
- 11** 11" high
- 15** 15" high (for use with 42" or 53" high frames)
- 18** 18" high (for use with 42" or 53" high frames)
- 22** 22" high
- 26** 26" high (for use with 42" or 53" high frames)
- 33** 33" high

Step 3. Type

- A** standard, no cable routing
- B** cable routing capability

Step 4. Surface Material

- P** painted
- W** veneer **A**

Prices for Steps 1-4.

	P	W
FT161. 07 A	\$42	172
B	\$67	213
11 A	\$44	187
B	\$69	232
15 A	\$46	205
B	\$72	264
18 A	\$48	217
B	\$74	289
22 A	\$49	228
B	\$75	315
26 A	\$51	244
B	\$77	348
33 A	\$54	268
B	\$80	396

Finished End, Change of Height

continued

Canvas Office Landscape® Walls

Step 5. Surface Finish

For painted (P)

8Q	folkstone grey	+\$0
91	white	+\$0
98	studio white	+\$0
CL	cool grey neutral	+\$0
G1	graphite	+\$0
WL	sandstone	+\$0
WN	warm grey neutral	+\$0
CN	metallic champagne	+\$0
EH	metallic bronze	+\$0
MS	metallic silver	+\$0

Wood Veneer

For veneer (W)

2U	light brown walnut <input type="checkbox"/> A	+\$0
40	dark brown walnut	+\$0
ED	aged cherry <input type="checkbox"/> A	+\$0
EK	medium red walnut	+\$0
EW	medium matte walnut	+\$0
ET	clear on ash <input type="checkbox"/> A	+\$0
EU	oak on ash <input type="checkbox"/> A	+\$0
EV	walnut on ash <input type="checkbox"/> A	+\$0
UL	natural maple <input type="checkbox"/> A	+\$0
UX	walnut on cherry <input type="checkbox"/> A	+\$0

Finished End, Architectural,
Change-Of-Height

FT16B.

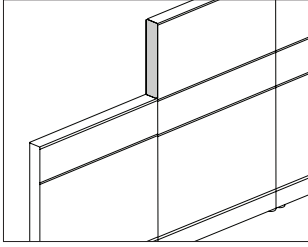

Product Information

Description

This cover finishes the exposed end of a frame when joining frames of unequal heights in a straight line. Light seal and attachment hardware included.

Notes

Change-of-height finished end can only be used in straight-line applications; it cannot be used with universal connector.

Change-of-height finished end does not have cable routing capability. Order frame top cap, architectural (FT11A.) separately.

Dimensions

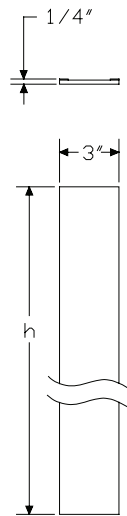

Specification Information

Step 1.

FT16B.

Step 2. Height

- 07** 7" high (for 42" and 53" high frames only)
- 11** 11" high
- 15** 15" high (for use with 42" or 53" high frames)
- 18** 18" high (for use with 42" or 53" high frames)
- 22** 22" high
- 26** 26" high (for use with 42" or 53" high frames)
- 33** 33" high

Step 3. Type

- A** standard, no cable routing

Step 4. Surface Material

- P** painted

Prices for Steps 1-4.

	P
FT16B. 07 A	\$154
11 A	\$157
15 A	\$164
18 A	\$168
22 A	\$171
26 A	\$179
33 A	\$187

Step 5. Surface Finish

8Q folkstone grey	+ \$0
98 studio white	+ \$0
WL sandstone	+ \$0

Bright Sand Texture Paint

91 white	+ \$0
CL cool grey neutral	+ \$0
G1 graphite	+ \$0
WN warm grey neutral	+ \$0

Metallic Paint

CN metallic champagne	+ \$0
EH metallic bronze	+ \$0
MS metallic silver	+ \$0

Finished End, for use with Gallery Panel FT16G.

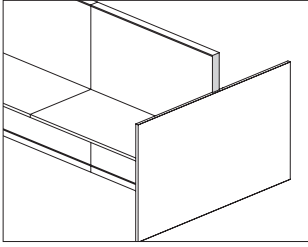

Product Information

Description

This change of height cover finishes the exposed end of a frame that is connected to a gallery panel of lower height. Attachment hardware included.

Notes

Specify this finished end only when gallery panel (FT115.) height is lower than height of attached frame.

Specify type (A) for use with architectural frame top caps (FT11A.), type (P) for use with standard painted top caps, or type (W) for use with standard veneer top caps (FT112.), ordered separately.

6", 13", or 17"-high finished ends are compatible with 29"-high gallery panels (FT115.).

7", 11", 18", or 22"-high finished ends are compatible with 35"-high gallery panels (FT115.).

11" or 15"-high finished ends are compatible with 42"-high gallery panels (FT115.).

7" or 11"-high finished ends are compatible with 46"-high gallery panels (FT115.).

Dimensions

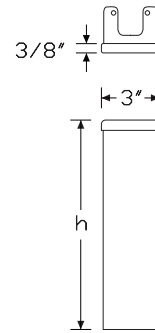

Standard

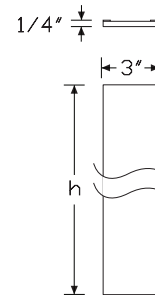

Architectural

Finished End, for use with Gallery
Panel *continued*

Specification Information

Step 1.

FT16G. A

Step 2. Height

- 06** 6" high A
- 07** 7" high A
- 11** 11" high A
- 13** 13" high A
- 15** 15" high A
- 17** 17" high A
- 18** 18" high A
- 22** 22" high A

Step 3. Type

- A** architectural trim A
- P** standard painted trim A
- W** standard veneer trim A

Prices for Steps 1-3.

	A	P	W
FT16G. 06	\$151	40	159
07	\$154	42	172
11	\$157	44	187
13	\$159	45	199
15	\$164	46	205
17	\$167	47	213
18	\$168	48	217
22	\$171	49	228

Step 4. Surface Finish

Bright Sand Texture Paint

For architectural trim (A) or standard painted trim (P)

- 91** white A +\$0
- CL** cool grey neutral A +\$0
- G1** graphite A +\$0
- WN** warm grey neutral A +\$0

For architectural trim (A) or standard painted trim (P)

- 8Q** folkstone grey +\$0
- 98** studio white +\$0
- WL** sandstone +\$0

Metallic Paint

For architectural trim (A) or standard painted trim (P)

- CN** metallic champagne A +\$0
- EH** metallic bronze A +\$0
- MS** metallic silver A +\$0

Wood Veneer

For standard veneer trim (W)

- 2U** light brown walnut A +\$0
- 40** dark brown walnut A +\$0
- ED** aged cherry A +\$0
- EK** medium red walnut A +\$0
- EW** medium matte walnut A +\$0
- ET** clear on ash A +\$0
- EU** oak on ash A +\$0
- EV** walnut on ash A +\$0
- UL** natural maple A +\$0
- UX** walnut on cherry A +\$0

Frame Top Cap

FT112.

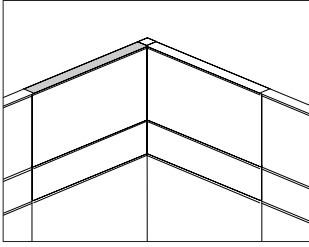

Canvas Office Landscape® Walls

Product Information

Description
This cap trims the top of a frame (or frames) and has a painted or veneer surface.

Notes
Upper tile (FT181.) must be specified on both sides of frame for top cap to attach.
Top cap with standard option (A) covers 1 frame.
Top cap with cable routing cutout on 1 end option (C) covers 1 frame and is used with a change-of-height finished end with cable routing capability.
When specifying option (C), order change-of-height finished end with cable routing capability (FT161.B) separately.
Specify option (D) for 54"-wide and wider top cap to span the combined width of 2 adjacent frames placed between 2 universal connectors or 1 universal connector and 1 finished end.
Specify option (E) for 54"-wide and wider top cap to span the combined width of 2 adjacent frames in runs of 3 frames or more.
Frame top cap is not required for frames with transaction surfaces, upmount screens, frame top screens, and frame top storage.

Dimensions

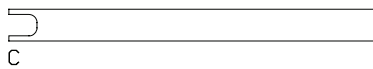
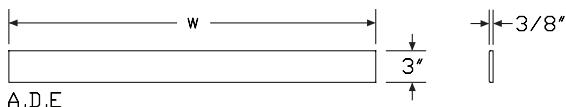

Specification Information

Step 1.
FT112.

Step 2. Width

- 18** 18" wide
- 24** 24" wide
- 30** 30" wide
- 36** 36" wide
- 42** 42" wide
- 48** 48" wide
- 54** 54" wide
- 60** 60" wide
- 66** 66" wide
- 72** 72" wide
- 78** 78" wide
- 84** 84" wide
- 90** 90" wide
- 96** 96" wide

Step 3. Type

For 18" wide (18), 24" wide (24), 30" wide (30), 36" wide (36), 42" wide (42), or 48" wide (48)
A standard
C cable routing cutout on 1 end

For 54" wide (54), 60" wide (60), 66" wide (66), 72" wide (72), 78" wide (78), 84" wide (84), 90" wide (90), or 96" wide (96)
D standard extended to span 2 frames **A**
E standard extended to span 2 frames in runs of 3 frames or more **A**

Step 4. Surface Material

For standard (A) or cable routing cutout on 1 end (C)
P painted
W veneer **A**

For standard extended to span 2 frames (D) or standard extended to span 2 frames in runs of 3 frames or more (E)
P painted

Prices for Steps 1-4.

	P	W
FT112. 18 A	\$27	124
C	\$33	122

Frame Top Cap *continued*

24 A	\$29	146
C	\$37	141
30 A	\$32	169
C	\$41	162
36 A	\$36	191
C	\$46	183
42 A	\$40	216
C	\$49	205
48 A	\$43	239
C	\$53	227
54 D	\$49	—
E	\$49	—
60 D	\$53	—
E	\$53	—
66 D	\$56	—
E	\$56	—
72 D	\$60	—
E	\$60	—
78 D	\$64	—
E	\$64	—
84 D	\$67	—
E	\$67	—
90 D	\$80	—
E	\$80	—
96 D	\$84	—
E	\$84	—

Step 5. Surface Finish

For painted (P)

8Q	folkstone grey	+\$0
91	white	+\$0
98	studio white	+\$0
CL	cool grey neutral	+\$0
G1	graphite	+\$0
WL	sandstone	+\$0
WN	warm grey neutral	+\$0
CN	metallic champagne	+\$0
EH	metallic bronze	+\$0
MS	metallic silver	+\$0

Wood Veneer

For veneer (W)

2U	light brown walnut <input type="checkbox"/> A	+\$0
40	dark brown walnut	+\$0
ED	aged cherry <input type="checkbox"/> A	+\$0
EK	medium red walnut	+\$0
EW	medium matte walnut	+\$0
ET	clear on ash <input type="checkbox"/> A	+\$0
EU	oak on ash <input type="checkbox"/> A	+\$0
EV	walnut on ash <input type="checkbox"/> A	+\$0
UL	natural maple <input type="checkbox"/> A	+\$0
UX	walnut on cherry <input type="checkbox"/> A	+\$0

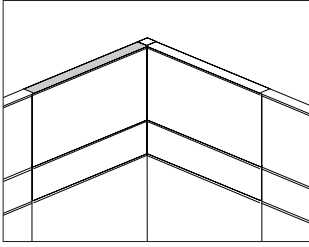

Product Information

Description

This top cap finishes the top of an individual frame, or can span 2 frames within a run. Attachment hardware included.

Notes

Frame top cap is not required for a frame with transaction surface, upmount screen, or frame top screen.

Not compatible with off-module 90° connector kit for equal-height frames (FT127.A).

Specify option (D) for 54"-wide and wider top cap to span the combined width of 2 adjacent frames placed between 2 universal connectors or 1 universal connector and 1 finished end.

Specify option (E) for 54"-wide and wider top cap to span the combined width of 2 adjacent frames in runs of 3 frames or more.

Dimensions

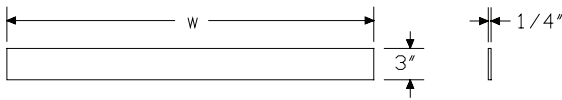

Specification Information

Step 1.

FT11A.

Step 2. Width

- 18** 18" wide
- 24** 24" wide
- 30** 30" wide
- 36** 36" wide
- 42** 42" wide
- 48** 48" wide
- 54** 54" wide
- 60** 60" wide
- 66** 66" wide
- 72** 72" wide
- 78** 78" wide
- 84** 84" wide
- 90** 90" wide
- 96** 96" wide

Step 3. Type

For 18" wide (18), 24" wide (24), 30" wide (30), 36" wide (36), 42" wide (42), or 48" wide (48)

A for single frame, no cutout

For 54" wide (54), 60" wide (60), 66" wide (66), 72" wide (72), 78" wide (78), 84" wide (84), 90" wide (90), or 96" wide (96)

D extended to span 2 frames, no cutout **A**

E extended to span 2 frames in runs of 3 frames or more, no cutout **A**

Step 4. Surface Material

P painted

Prices for Steps 1-4.

	P
FT11A. 18 A	\$56
24 A	\$66
30 A	\$76
36 A	\$85
42 A	\$94
48 A	\$106
54 D	\$113
E	\$113
60 D	\$125
E	\$125

Frame Top Cap, Architectural

continued

66 D	\$134
E	\$134
72 D	\$144
E	\$144
78 D	\$154
E	\$154
84 D	\$163
E	\$163
90 D	\$187
E	\$187
96 D	\$199
E	\$199

Step 5. Surface Finish

8Q	folkstone grey	+\$0
98	studio white	+\$0
WL	sandstone	+\$0

Bright Sand Texture Paint

91	white	+\$0
CL	cool grey neutral	+\$0
G1	graphite	+\$0
WN	warm grey neutral	+\$0

Metallic Paint

CN	metallic champagne	+\$0
EH	metallic bronze	+\$0
MS	metallic silver	+\$0

Finished End, Architectural,
Privacy Door

FT16D.

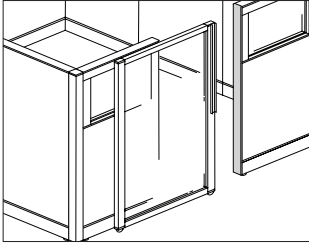

Canvas Office Landscape® Walls

Product Information

Description

This painted cover finishes the exposed end of a single frame or covers the combined height of a frame and stacking frames when a privacy door with lock is used. Light seal and attachment hardware included.

Notes

Specify finished end to match height of frame or combined height of frame and stacking frame(s).

Dimensions

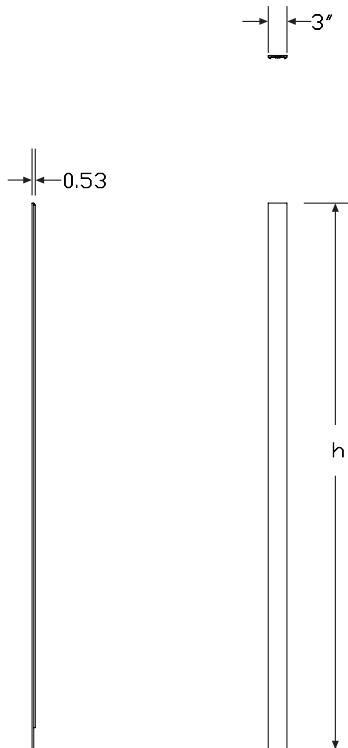

Specification Information

Step 1.

FT16D. [A]

Step 2. Height

57 57" high [A]

68 68" high [A]

Step 3. Base Option

A open base / architectural foot [A]

B base cover/to-the-floor tile [A]

Step 4. Surface Material

P painted [A]

Prices for Steps 1-4.

	P
FT16D. 57 A	\$291
B	\$300
68 A	\$319
B	\$327

Step 5. Surface Finish

8Q folkstone grey [A]	+\$0
98 studio white [A]	+\$0
WL sandstone [A]	+\$0

Bright Sand Texture Paint

91 white [A]	+\$0
CL cool grey neutral [A]	+\$0
G1 graphite [A]	+\$0
WN warm grey neutral [A]	+\$0

Metallic Paint

CN metallic champagne [A]	+\$0
EH metallic bronze [A]	+\$0
MS metallic silver [A]	+\$0

Frame Top Cap, Architectural, Privacy Door

FT11B.

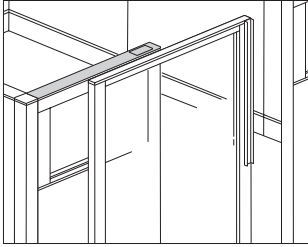

Product Information

Description

This painted top cap finishes the top of a frame when a privacy door is used with architectural trim products. Attachment hardware included.

Notes

Match width of top cap to width of frame.

Dimensions

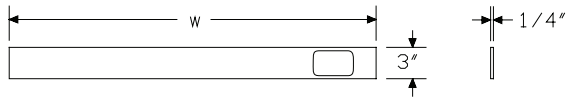

Specification Information

Step 1.

FT11B. A

Step 2. Width

- 24** 24" wide A
- 30** 30" wide A
- 36** 36" wide A
- 42** 42" wide A
- 48** 48" wide A

Prices for Steps 1-2.

FT11B. 24	\$204
30	\$220
36	\$236
42	\$254
48	\$271

Step 3. Surface Finish

Bright Sand Texture Paint

8Q	folkstone grey	+\$0
91	white <input type="checkbox"/> A	+\$0
98	studio white	+\$0
CL	cool grey neutral <input type="checkbox"/> A	+\$0
G1	graphite <input type="checkbox"/> A	+\$0
WL	sandstone	+\$0
WN	warm grey neutral <input type="checkbox"/> A	+\$0

Metallic Paint

CN	metallic champagne <input type="checkbox"/> A	+\$0
EH	metallic bronze <input type="checkbox"/> A	+\$0
MS	metallic silver <input type="checkbox"/> A	+\$0

90° Connector Top Cap

FT126.

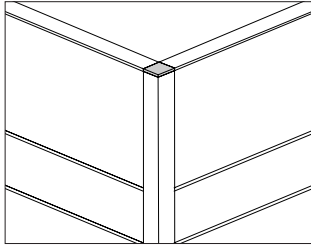

Canvas Office Landscape® Walls

Product Information

Description

This cap trims the top of a connector or stacking connector and has a painted or veneer surface. Attachment hardware is included.

Notes

Specify top cap to connect into total number of adjacent equal-height frame top caps.

Order the following products separately:

- 90° connector cover (FT123.)
- Frame top cap (FT112.)

Dimensions

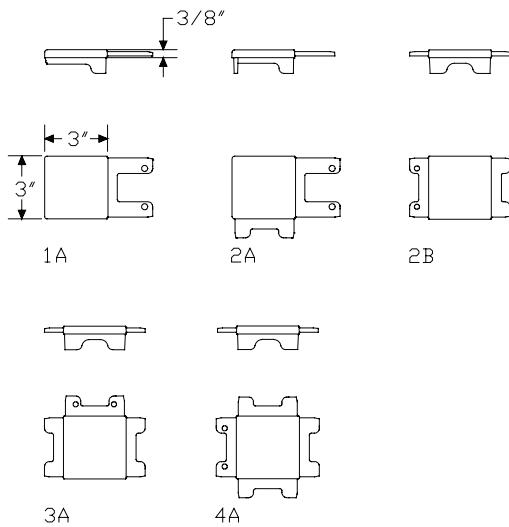

Specification Information

Step 1.

FT126.

Step 2. Configuration

- 1A** for 1 frame top cap
- 2A** for 2 frame top caps, 90°
- 2B** for 2 frame top caps, 180°
- 3A** for 3 frame top caps
- 4A** for 4 frame top caps

Step 3. Surface Material

- P** painted
- W** veneer A

Prices for Steps 1-3.

	P	W
FT126. 1A	\$31	116
2A	\$31	116
2B	\$31	116
3A	\$31	116
4A	\$31	116

Step 4. Surface Finish

Bright Sand Texture Paint

For painted (P)

91	white	+\$0
CL	cool grey neutral	+\$0
G1	graphite	+\$0
WN	warm grey neutral	+\$0

For painted (P)

8Q	folkstone grey	+\$0
98	studio white	+\$0
WL	sandstone	+\$0

Metallic Paint

For painted (P)

CN	metallic champagne	+\$0
EH	metallic bronze	+\$0
MS	metallic silver	+\$0

90° Connector Top Cap *continued*

Wood Veneer

For veneer (W)

2U	light brown walnut <input type="checkbox"/> A	+\$0
40	dark brown walnut	+\$0
ED	aged cherry <input type="checkbox"/> A	+\$0
EK	medium red walnut	+\$0
EW	medium matte walnut	+\$0
ET	clear on ash <input type="checkbox"/> A	+\$0
EU	oak on ash <input type="checkbox"/> A	+\$0
EV	walnut on ash <input type="checkbox"/> A	+\$0
UL	natural maple <input type="checkbox"/> A	+\$0
UX	walnut on cherry <input type="checkbox"/> A	+\$0

90° Connector Top Cap, Architectural

FT12A.

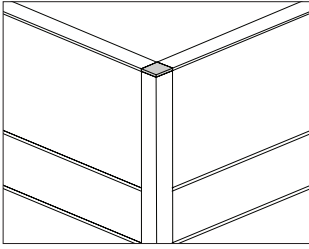

Canvas Office Landscape® Walls

Product Information

Description

This cap finishes the top of an architectural connector or stacking connector. Attachment hardware is included.

Notes

Specify top cap to connect into total number of adjacent equal-height frame top caps.

the following products separately:

- 90° connector cover, architectural (FT12B.)
- Frame top cap, architectural (FT11A.)

Dimensions

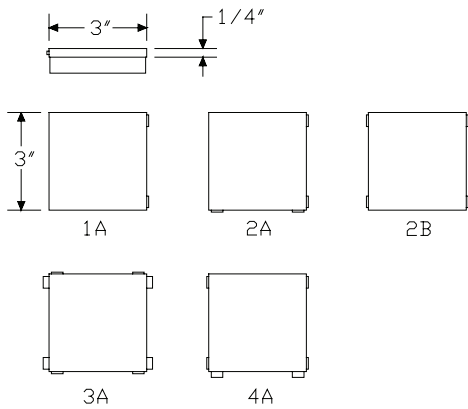

Specification Information

Step 1.

FT12A.

Step 2. Configuration

- 1A** for 1 frame top cap
- 2A** for 2 frame top caps, 90°
- 2B** for 2 frame top caps, 180°
- 3A** for 3 frame top caps
- 4A** for 4 frame top caps

Step 3. Surface Material

P painted

Prices for Steps 1-3.

	P
FT12A. 1A	\$25
2A	\$25
2B	\$25
3A	\$25
4A	\$25

Step 4. Surface Finish

8Q	folkstone grey A	+\$0
98	studio white A	+\$0
WL	sandstone A	+\$0

Bright Sand Texture Paint

91	white	+\$0
CL	cool grey neutral	+\$0
G1	graphite	+\$0
WN	warm grey neutral	+\$0

Metallic Paint

CN	metallic champagne	+\$0
EH	metallic bronze	+\$0
MS	metallic silver	+\$0

120° Connector Top Cap

FT136.

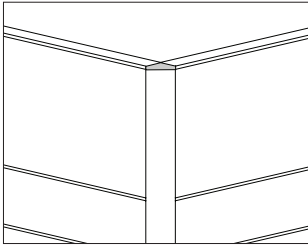

Product Information

Description

This cap trims the top of a 120° connector or 120° stacking connector and has a painted or veneer surface. Attachment hardware is included.

Notes

Specify top cap to connect into total number of adjacent equal-height frame top caps.

Order the following products separately:

- 120° connector cover (FT133.)
- Frame top cap (FT112.)

Dimensions

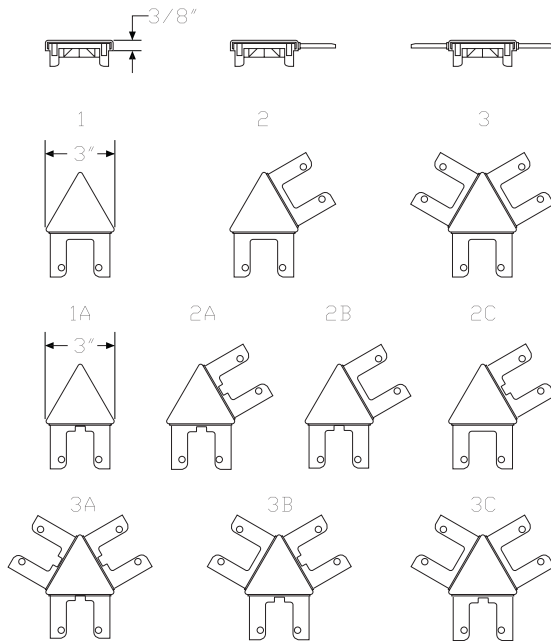

Specification Information

Step 1.

FT136.

Step 2. Configuration

- 1** connects into 1 frame top cap
- 1A** connects into 1 frame top screen
- 2** connects into 2 frame top caps
- 2A** connects into 2 frame top screens
- 2B** connects into frame top screen left, frame top cap right
- 2C** connects into frame top cap left and frame top screen right
- 3** connects into 3 frame top caps
- 3A** connects into 3 frame top screens
- 3B** connects into frame top screen 2 sides, frame top cap 1 side
- 3C** connects into frame top screen 1 side, frame top cap 2 sides

Step 3. Surface Material

For connects into 1 frame top cap (1) or connects into 2 frame top caps (2)

- P** painted
- W** veneer A

For connects into 3 frame top caps (3)

- P** painted
- W** veneer A

For connects into 1 frame top screen (1A), connects into 2 frame top screens (2A), connects into frame top screen left, frame top cap right (2B), connects into frame top cap left and frame top screen right (2C), connects into 3 frame top screens (3A), connects into frame top screen 2 sides, frame top cap 1 side (3B), or connects into frame top screen 1 side, frame top cap 2 sides (3C)

- P** painted

Prices for Steps 1-3.

	P	W
FT136. 1	\$34	106
1A	\$56	—
2	\$34	106
2A	\$56	—
2B	\$56	—
2C	\$56	—
3	\$34	106
3A	\$56	—
3B	\$56	—
3C	\$56	—

120° Connector Top Cap *continued*

Step 4. Surface Finish

For painted (P)

8Q	folkstone grey <input type="checkbox"/> A	+\$0
98	studio white <input type="checkbox"/> A	+\$0
WL	sandstone <input type="checkbox"/> A	+\$0

Bright Sand Texture Paint

For painted (P)

91	white	+\$0
CL	cool grey neutral	+\$0
G1	graphite	+\$0
WN	warm grey neutral	+\$0

Metallic Paint

For painted (P)

CN	metallic champagne	+\$0
EH	metallic bronze	+\$0
MS	metallic silver	+\$0

Wood Veneer

For veneer (W)

2U	light brown walnut <input type="checkbox"/> A	+\$0
40	dark brown walnut <input type="checkbox"/> A	+\$0
ED	aged cherry <input type="checkbox"/> A	+\$0
EK	medium red walnut <input type="checkbox"/> A	+\$0
EW	medium matte walnut <input type="checkbox"/> A	+\$0
UL	natural maple <input type="checkbox"/> A	+\$0
UX	walnut on cherry <input type="checkbox"/> A	+\$0

Wall Start

FT190.

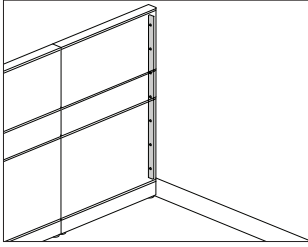

Product Information

Description

This assembly connects a frame to an architectural wall or column at a 90° angle.

Wall starts require the following quantities of fasteners:

Height—Fasteners

- 35" — 5
- 42" — 5
- 46" — 5
- 53" — 5
- 57" — 5
- 68" — 6
- 79" — 7

Notes

- Specify height of wall start to match frame height.
- Order wall fasteners (X1192.) separately.

Dimensions

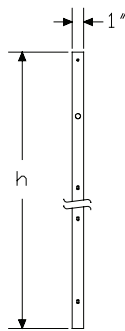

Specification Information

Step 1.

FT190.

Step 2. Height

- 35** 35" high
- 42** 42" high
- 46** 46" high
- 53** 53" high
- 57** 57" high
- 68** 68" high
- 79** 79" high

Prices for Steps 1-2.

FT190. 35	\$62
42	\$65
46	\$68
53	\$70
57	\$73
68	\$79
79	\$90

Wall Fastener

X1192.

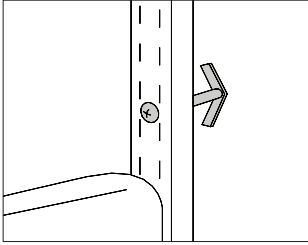

Canvas Office Landscape® Walls

Product Information

Description
 This black pan head fastener attaches a wall strip to a wall. Package contains 100.

Notes

Specify fastener based on wall construction:

- 1½"-long #10 pan head sheet metal screw (X1192.1) fastens into anchors in cement blocks, poured walls, and brick
- 3"-long #10 pan head sheet metal screw (X1192.2) fastens into studs or TC toggles in drywall
- 3"-long #10 pan head machine screw (X1192.3) fastens into toggle wall strip anchor (X1191.) or wing toggle in drywall.

For drywall applications using X1192.3 wall fasteners, toggle wall strip anchors (X1191.) or equivalent fasteners are recommended; order separately.

Specification Information

Step 1.
X1192.

Step 2. Size

- 1** no. 10, 1½" sheet metal screw
- 2** no. 10, 3" sheet metal screw
- 3** no. 10, 3" machine screw

Prices for Steps 1-2.

X1192. 1	\$32
2	\$32
3	\$55

Wall Start Filler

FT920.

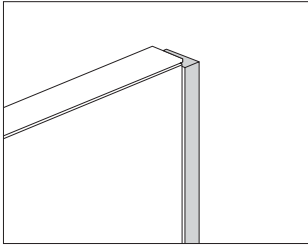

Product Information

Description

This fiberboard filler attaches between the architectural wall and a wall start used adjacent to a wall strip. Filler is coated with black primer and can be painted in the field.

Notes

Match height of wall start filler to height of wall start and frame.

Dimensions

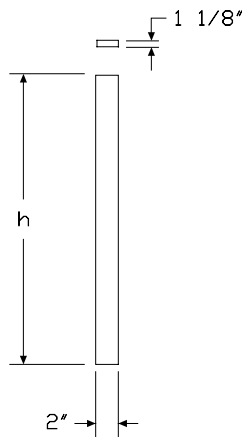

Specification Information

Step 1.

FT920.

Step 2. Height

35	35" high
42	42" high
46	46" high
53	53" high
57	57" high
68	68" high
79	79" high

Prices for Steps 1-2.

FT920. 35	\$135
42	\$141
46	\$147
53	\$162
57	\$169
68	\$175
79	\$180

Wall Strip

FT191.

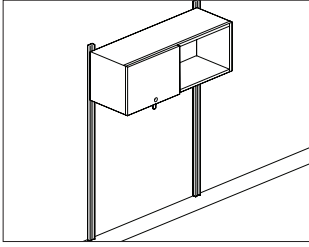

Canvas Office Landscape® Walls

Product Information

Description

This double-slotted strip attaches to an architectural wall to support hanging components. 2 wall strips are required to hang a component.

Wall strips require the following quantities of fasteners:

Height — Fasteners

- 42" — 5
- 46" — 5
- 53" — 6
- 57" — 7
- 68" — 8
- 79" — 9

Notes

Order wall fasteners (X1192.) and toggle wall strip anchors (X1191.) separately.

When attaching tiles to wall strips, order tile adapters (FT192.) and appropriate tile trim separately:

- Tile trim, wall strip (FT167.)
- Vertical trim (FT197.)

2 side-by-side hanging components can share a double-slotted wall strip.

Dimensions

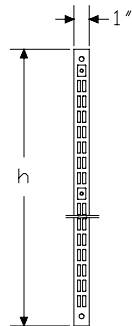

Specification Information

Step 1.

FT191.

Step 2. Height

- 42** 42" high
- 46** 46" high
- 53** 53" high
- 57** 57" high
- 68** 68" high
- 79** 79" high

Prices for Steps 1-2.

FT191. 42	\$58
46	\$60
53	\$62
57	\$64
68	\$69
79	\$75

Step 3. Finish

BU black umber	+\$0
-----------------------	------

Toggle Wall Strip Anchor

X1191.

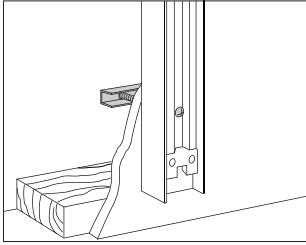

Product Information

Description

This anchor provides extra support for a wall hanger strip. Package contains 100.

Notes

Recommended for use in all drywall installations. Use with wall fastener (X1192.3).

Dimensions

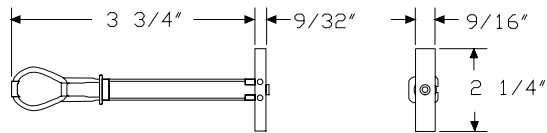

Specification Information

Step 1.

X1191.

\$381

Tile Adapters, Wall Strip

FT192.

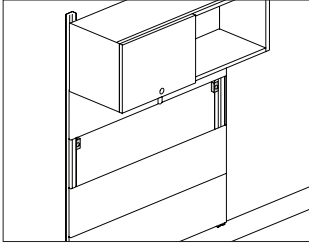

Canvas Office Landscape® Walls

Product Information

Description

These adapters are used to hang a tile from wall strips. It cannot be used with a window tile, open tile, or upper/lower power/data tile.

Notes

Specify height of tile adapters to match height of attaching tile.

Order wall strip (FT191.) and appropriate tile trim separately:

- Tile trim, wall strip (FT167.)
- Vertical Trim (FT197.)

The number of tile adapters varies by tile height; appropriate quantity is included. Tile adapter quantities are as follows:

Tile Height—Adapter Quantity

- 07"—2
- 11"—2
- 18"—2
- 19"—4
- 22"—2
- 30"—6
- 33"—4
- 37"—6
- 41" to 63"—8

Dimensions

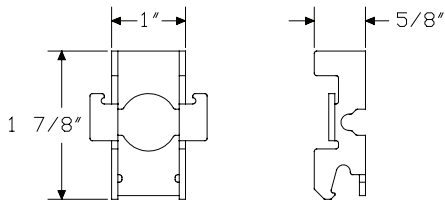

Specification Information

Step 1.

FT192.

Step 2. Tile Height

- 07** 7" high A
- 11** 11" high
- 18** 18" high A
- 19** 19" high
- 22** 22" high
- 30** 30" high
- 33** 33" high
- 37** 37" high A
- 41** 41" high
- 48** 48" high A
- 52** 52" high
- 63** 63" high

Prices for Steps 1-2.

FT192. 07	\$23
11	\$23
18	\$23
19	\$44
22	\$23
30	\$64
33	\$44
37	\$64
41	\$85
48	\$64
52	\$85
63	\$85

Tile Trim, Wall Strip

FT167.

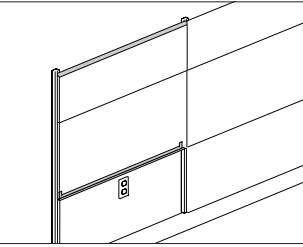

Product Information

Description

This trim kit finishes the top and bottom edges of tile(s) attached to wall strips. It secures the tile edge to the wall strips and provides a horizontal bead along the bottom edge of the lowest tile.

Notes

Specify width of tile trim to match width of attaching tiles.

1 kit finishes the top edge of the highest tile and the bottom edge of the lowest tile.

When bottom tile does not reach the base of the wall strips, specify option A. When bottom tile is placed at the base of the wall strips, specify option B.

19"- and 30"-high lower tiles and full-height tiles must always be placed at the base of the wall strips. Specify option B for these products.

Dimensions

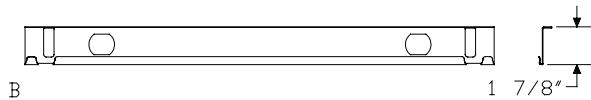
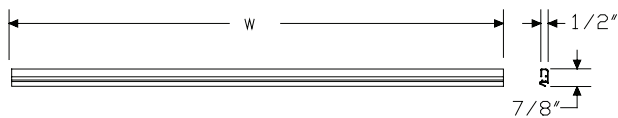
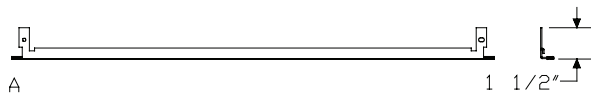
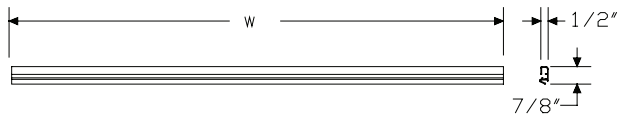

Specification Information

Step 1.

FT167.

Step 2. Width

24	24" wide
30	30" wide
36	36" wide
42	42" wide
48	48" wide

Step 3. Application

A	top/mid-level lower tile trim
B	top/base-level lower tile trim

Prices for Steps 1-3.

	A	B
FT167. 24	\$116	49
30	\$123	54
36	\$129	57
42	\$134	59
48	\$143	63

Step 4. Finish

8Q	folkstone grey	+\$0
91	white	+\$0
98	studio white	+\$0
CL	cool grey neutral	+\$0
G1	graphite	+\$0
LU	soft white	+\$0
MT	medium tone	+\$0
WL	sandstone	+\$0
WN	warm grey neutral	+\$0

Vertical Trim, Wall Strip

FT197.

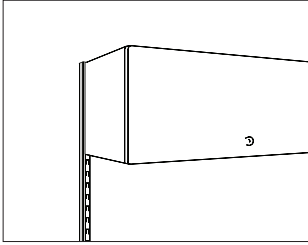

Canvas Office Landscape® Walls

Product Information

Description

This vertical trim finishes 1 exposed side edge of a wall strip.

Notes

Specify height of vertical trim to match height of wall strip.

Order wall strip (FT191.) separately.

When tile adapter is attached, vertical trim cannot be used on inside edge of wall strip.

Dimensions

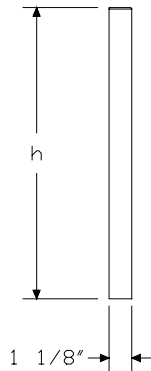

Specification Information

Step 1.

FT197.

Step 2. Height

46A	46" high
57A	57" high
68A	68" high
79A	79" high

Prices for Steps 1-2.

FT197. 46A	\$63
57A	\$71
68A	\$79
79A	\$89

Step 3. Finish

Bright Sand Texture Paint

91	white	+\$0
CL	cool grey neutral	+\$0
G1	graphite	+\$0
WN	warm grey neutral	+\$0
8Q	folkstone grey	+\$0
98	studio white	+\$0
WL	sandstone	+\$0

Base Power Harness

FT150.

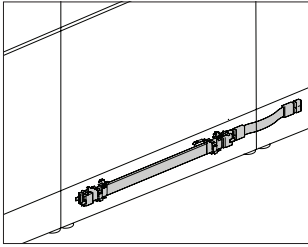

Product Information

Description

This harness converts a nonpowered frame to a powered frame at the base. It distributes up to 4 20-amp circuits and provides 2 receptacle locations on each side of the frame; 24"-wide harness has 1 receptacle location. The harness is UL listed and Canadian UL listed.

Notes

Order 4-circuit receptacle (FT155, or FT156.) separately.

When routing power through a universal connector in a straight line, order power harness extender (FT151.) separately.

Harness must be field installed.

Dimensions

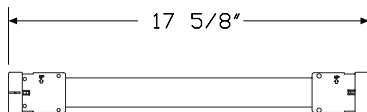
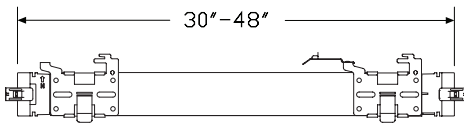
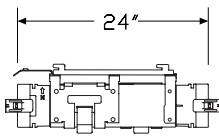

Specification Information

Step 1.

FT150.

Step 2. Width

24	24" wide
30	30" wide
36	36" wide
42	42" wide
48	48" wide

Prices for Steps 1-2.

FT150. 24	\$126
30	\$131
36	\$136
42	\$143
48	\$151

Step 3. Wiring Type

LZ	PVC-free	+\$0
-----------	----------	------

Power Harness, Lower Power/
Data Tile FT152.

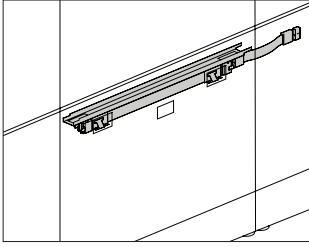

Product Information

Description

This power harness is used with a lower power/data tile. It distributes up to 4 20-amp circuits and includes a support bar for attaching the harness to the frame. The harness can be used just above the surface (except on a 35"-high frame), just below the surface, or near the frame's base. It is UL listed and Canadian UL listed.

24"-wide harness has 1 receptacle location on each side of the frame;
30"- to 48"-wide harnesses have 2 receptacle locations on each side.

Notes

Order the following products separately:

- 4-circuit receptacle (FT155, or FT156.)
- Lower power/data tile (FT171., FT172., FT17R. or FT36R.)

When routing power through universal connectors in a straight line, order power harness extender (FT151.) separately.

Dimensions

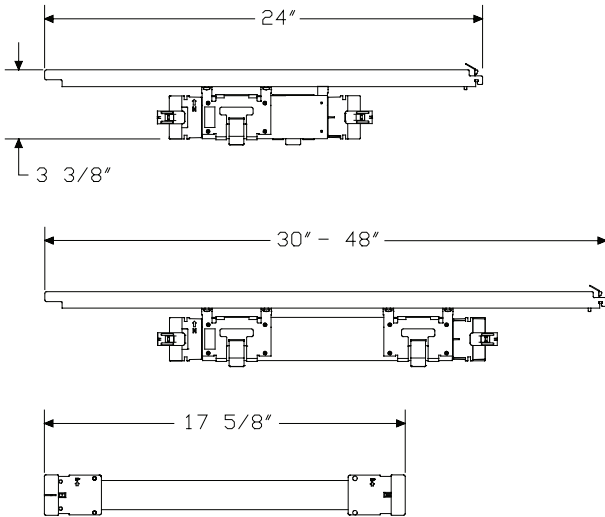

Specification Information

Step 1.

FT152.

Step 2. Width

24	24" wide
30	30" wide
36	36" wide
42	42" wide
48	48" wide

Prices for Steps 1-2.

FT152. 24	\$172
30	\$180
36	\$184
42	\$189
48	\$194

Step 3. Wiring Type

LZ	PVC-free	+\$0
-----------	----------	------

Power Harness, Upper Power/
Data Tile

FT153.

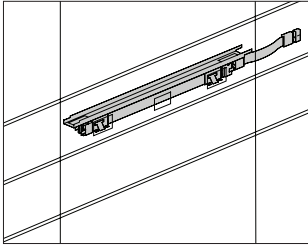

Product Information

Description

This power harness is used with an upper power/data tile. It distributes up to 4 20-amp circuits, provides 2 receptacle locations on each side of a frame, and includes a support bar for attaching the harness to the frame. The harness is UL listed and Canadian UL listed.

The harness can be used on a 46"-high or higher frame, in the activity zone at 46", 57", or 68", or used on a 22"-high stacking frame. Harness used on a 22"-high stacking frame can be used at the bottom of the tile. 24"-wide harness has 1 receptacle location on each side of the frame; 30"- to 48"-wide harnesses have 2 receptacle locations on each side.

Notes

Order the following products separately:

- 4-circuit receptacle (FT155, or FT156.)
- Upper power/data tile (FT184.)

When routing power through universal connectors in a straight line, order power harness extender (FT151.) separately.

Dimensions

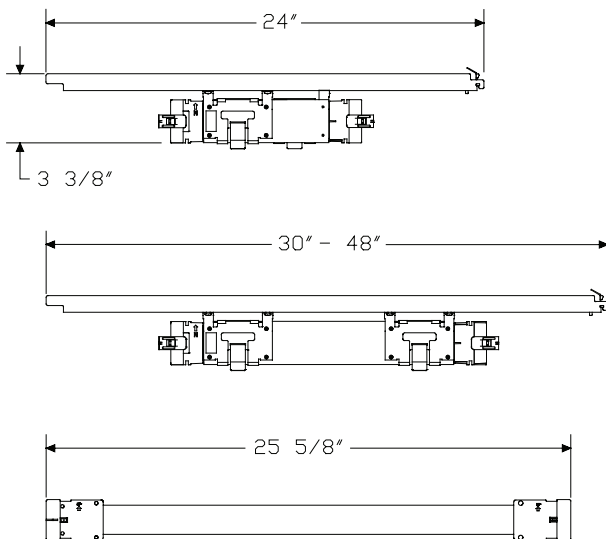

Specification Information

Step 1.

FT153.

Step 2. Width

24	24" wide
30	30" wide
36	36" wide
42	42" wide
48	48" wide

Prices for Steps 1-2.

FT153. 24	\$183
30	\$191
36	\$195
42	\$199
48	\$205

Step 3. Wiring Type

LZ	PVC-free	+\$0
-----------	----------	------

Power Harness, Low Credenza Height

FT15A.

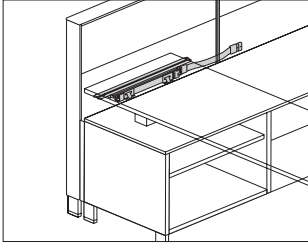

Canvas Office Landscape® Walls

Product Information

Description

This power harness is used with a low credenza height power/data tile. It distributes up to 4 20-amp circuits and includes a support bar for attaching the harness to the frame at a height just above a low credenza. It is UL listed and Canadian UL listed. Attachment hardware included.

Order the following products separately:

- 4-circuit receptacle (FT155, or FT156.)
- Lower power/data tile, low credenza height (FT371., FT372., or FT37R.)

Notes

When routing power through universal connectors in a straight line, order power harness extender (FT151.) separately.

Receptacle locations for the 3 duplex power harness (FT15A.3) are back-to-back and offset from center (left or right) of a frame. If 3 duplex receptacles are needed on both sides of a frame, order the 3 duplex low credenza height tile (FT371., FT372., FT37R.) with left orientation (F) option on 1 side of the frame, and with right orientation (G) option on the other side of the frame.

Dimensions

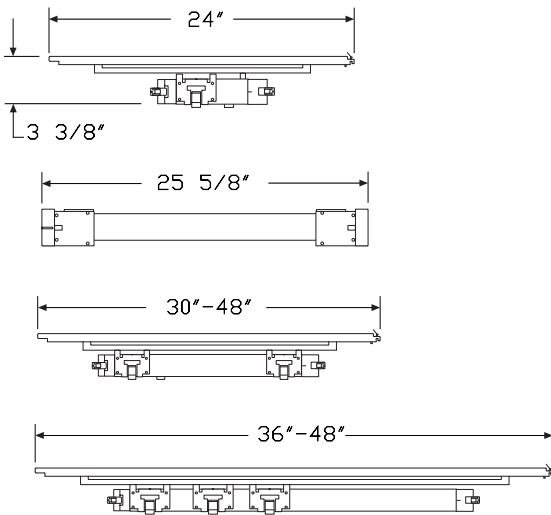

Specification Information

Step 1.

FT15A. A

Step 2. Harness Type

- 1 for 1 duplex receptacle A
- 2 for 2 duplex receptacles A
- 3 for 3 duplex receptacles A

Step 3. Width

For 1 duplex receptacle (1)

24 24" wide A

For 2 duplex receptacles (2)

- 30 30" wide A
- 36 36" wide A
- 42 42" wide A
- 48 48" wide A

For 3 duplex receptacles (3)

- 36 36" wide A
- 42 42" wide A
- 48 48" wide A

Prices for Steps 1-3.

	24	30	36	42	48
FT15A. 1	\$223	—	—	—	—
2	—	\$238	251	266	292
3	—	—	\$283	299	316

Step 4. Wiring Type

LZ PVC-free + \$0

Hardwire Mounting Kit

FT157.

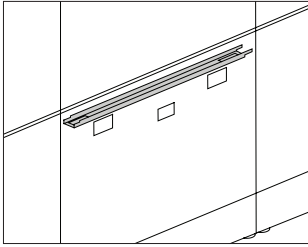

Product Information

Description

This rail is used to mount a hardwired junction box above a frame's base. It can be used with a lower power/data tile or upper power/data tile. Attachment hardware is included.

Notes

Junction boxes are not included; order separately through local supplier. Mounting rail will not attach to the location immediately above a low credenza. To place hardwire power in this location, specify hardwire mounting kit, low credenza (FT15C.) separately.

Order lower power/data tile (FT171. or FT172.) or upper power/data tile (FT184.) separately.

When using hardwired junction boxes in base of frame, hardwire mounting rail is not required.

Mounting rail's primary use is for Chicago.

Dimensions

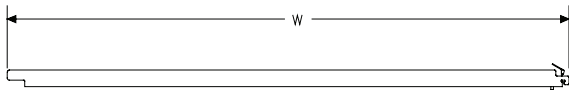

Specification Information

Step 1.

FT157.

Step 2. Width

24	24" wide
30	30" wide
36	36" wide
42	42" wide
48	48" wide

Prices for Steps 1-2.

FT157. 24	\$33
30	\$35
36	\$38
42	\$41
48	\$43

Hardwire Mounting Kit, Low Credenza Height

FT15C.

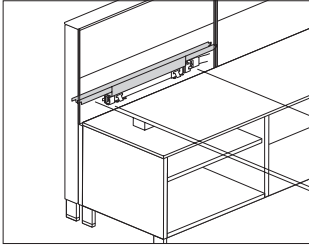

Canvas Office Landscape® Walls

Product Information	
Description	
This rail is used with a low credenza height power/data tile for mounting a hardwired junction box within a frame at a height just above a low credenza. Attachment hardware included.	
Notes	
Junction boxes are not included. Order lower power/data tile, low credenza height (FT371., FT372., or FT37R.) separately.	
Dimensions	

Specification Information	
Step 1.	
FT15C. <input type="checkbox"/> A	
Step 2. Width	
36	36" wide <input type="checkbox"/> A
42	42" wide <input type="checkbox"/> A
48	48" wide <input type="checkbox"/> A
Prices for Steps 1-2.	
FT15C. 36	\$101
42	\$114
48	\$123

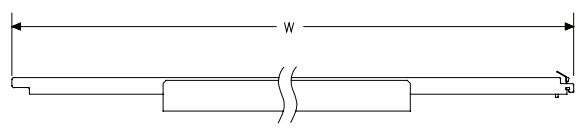

Power Harness Extender

FT151.

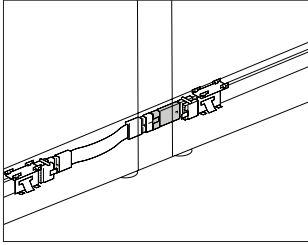

Product Information

Description

This product extends a power harness by 3" when used to route power through a connector in a straight line. It can be used at the base, at surface height, or any height where power can be routed through the frame (every 11").

Notes

Harness extender is not required when routing power harness through a connector at a 90° or 120° angle.

Dimensions

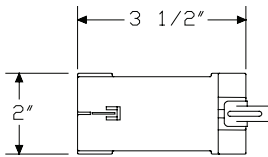

Specification Information

Step 1.

FT151.

\$29

Power Jumper

FT154.

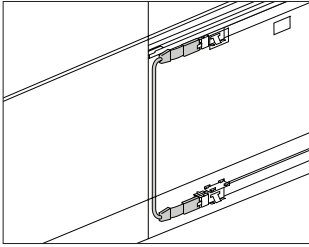

Canvas Office Landscape® Walls

Product Information

Description

This power jumper connects power vertically from 1 power harness to another. It connects power within a frame or between adjacent frames. The power jumper connects into the end of a harness; it does not connect into a receptacle location. The power jumper is UL listed and Canadian UL listed.

The power jumper cannot be used with a window tile or open tile.

Dimensions

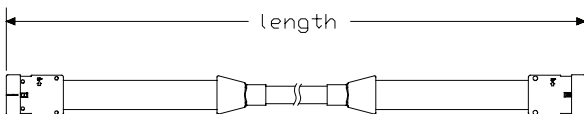
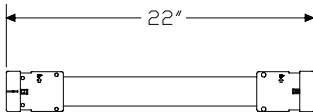

Specification Information

Step 1.

FT154.

Step 2. Length

- 1 22" long
- 2 36" long
- 3 47" long
- 4 58" long
- 5 69" long
- 6 80" long

Prices for Steps 1-2.

FT154. 1	\$72
2	\$100
3	\$114
4	\$126
5	\$137
6	\$147

Step 3. Wiring Type

LZ	PVC-free	+ \$0
-----------	----------	-------

Power Entry, Internal Direct Connect, 4 Circuit

FT144.

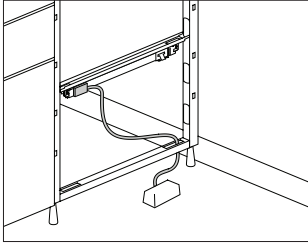

Product Information

Description

This power entry connects a building's electrical supply from a wall, floor, or column to a powered frame. It enters the frame through 2 rectangular cutouts in the bottom rail of an open-base frame. The power entry plugs into the left-hand receptacle outlet on a power harness and includes a cable that can be field cut to the appropriate length. Due to the location of the power entry connection, only 3 receptacle locations remain available in the frame harness. It is UL listed and Canadian UL listed.

Notes

Power entry connects directly to the harness above the open base or connects above or below a surface.

Power entry cannot route through a connector.

When bringing power in from the floor, power entry cannot be used on frames with a base. Order power entry external direct connect (FT140.) for this application.

Power entry not compatible with 3-receptacle version of the low credenza height power harness (FT15A.3).

Licensed electrician must wire power entry.

PVC coated liquid tight conduit.

Dimensions

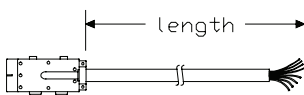

Specification Information

Step 1.

FT144.

Step 2. Length

06	6' long
12	12' long
18	18' long
24	24' long

Prices for Steps 1-2.

FT144. 06	\$199
12	\$276
18	\$335
24	\$395

Step 3. Wiring Type

LZ	PVC-free	+\$0
-----------	----------	------

Power Entry, External Direct Connect

FT140.

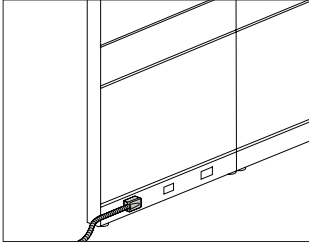

Canvas Office Landscape® Walls

Product Information

Description

This power entry connects a building's electrical supply from a wall, floor, or column to the base of a powered frame. It plugs directly into a receptacle location on the frame's base to distribute up to 4 20-amp circuits. The power entry is manufactured in a right-hand direction but can be field converted to a left-hand direction. The cable is available in 4 lengths and can be field cut to the appropriate length. It is UL listed and Canadian UL listed.

Notes

Licensed electrician must wire power entry.
 PVC coated liquid tight conduit.
 For easier installation of power entry, order retrofit base cover for power entry (FT162.) separately.

Dimensions

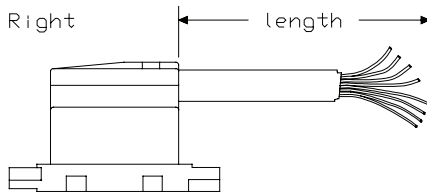

Top View

Specification Information

Step 1.

FT140.

Step 2. Length

06	6' long
12	12' long
18	18' long
24	24' long

Prices for Steps 1-2.

FT140. 06	\$175
12	\$235
18	\$299
24	\$362

Step 3. Wiring Type

LZ	PVC-free	+\$0
-----------	----------	------

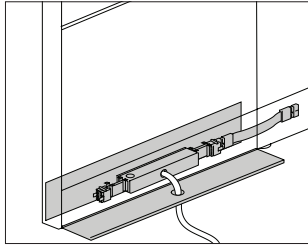

Product Information

Description

This power entry connects a building's electrical supply from a wall, floor, or column into a frame. It includes a junction box, 8" of wire, 1 or 2 harnesses, and optional base. The power entry does not provide receptacle access. It is UL listed and Canadian UL listed.

Notes

For power entry used with base covers (FT141.B), 2 base covers are included to replace standard base covers included with a frame.
 If entering power at location other than the base, mounting rail must be used (mounting rail is included with the power entry).

Dimensions

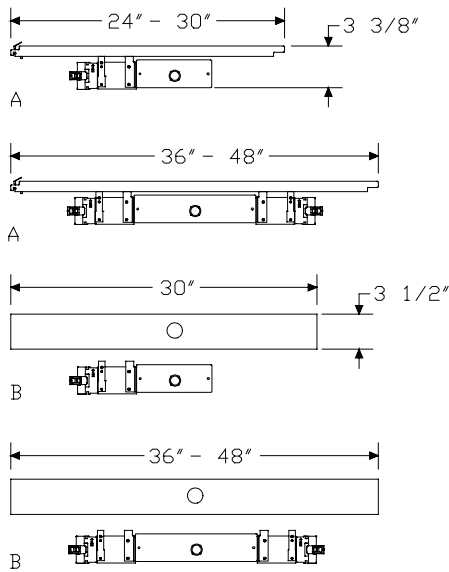

Specification Information

Step 1.

FT141.

Step 2. Width

24	24" wide
30	30" wide
36	36" wide
42	42" wide
48	48" wide

Step 3. Usage

For 24" wide (24)

A use with open base

For 30" wide (30), 36" wide (36), 42" wide (42), or 48" wide (48)

A use with open base

B use with base covers

Prices for Steps 1-3.

	A	B
FT141. 24	\$545	—
30	\$569	589
36	\$589	608
42	\$631	654
48	\$674	696

Step 4. Wiring Type

LZ PVC-free +\$0

Step 5. Base Finish

For use with base covers (B)

Bright Sand Texture Paint

8Q	folkstone grey	+\$0
91	white	+\$0
98	studio white	+\$0
CL	cool grey neutral	+\$0
G1	graphite	+\$0
WL	sandstone	+\$0
WN	warm grey neutral	+\$0

Metallic Paint

CN	metallic champagne	+\$0
EH	metallic bronze	+\$0
MS	metallic silver	+\$0

Ceiling Power Entry, End of Run FT142.

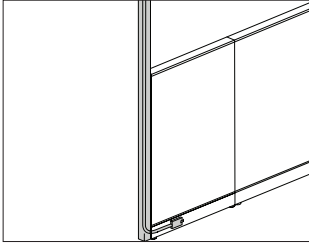

Product Information

Description
 This power entry connects a ceiling's electrical supply to the end of a frame run. It distributes up to 4 20-amp circuits. The power entry has a 10'-high pole that can be field cut to the appropriate length, ceiling trim, connecting hardware, conduit, and a factory-installed electrical harness. The power entry plugs into the end of the harness; it does not connect into a receptacle location. The power entry is UL listed and Canadian UL listed.

Notes

Finished end is not required for frames with an end-of-run ceiling power entry.
 When using with stacking frames, specify frame height of power entry to match the combined height of the frame and stacking frame.
 Licensed electrical must wire power entry.
 For cable capacity information, see Cable Capacity Charts in Omni.

Dimensions

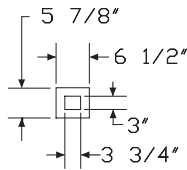

Specification Information

Step 1.
FT142.

Step 2. Frame Height

42	42" high
46	46" high
53	53" high
57	57" high
64	64" high
68	68" high
79	79" high

Step 3. Base Option

A	open base, tapered foot
B	base cover

Step 4. Power

For open base, tapered foot (A)

N	nonpowered
A	4-circuit power connects above surface

For base cover (B)

N	nonpowered
A	4-circuit power connects above surface
E	4-circuit power connects in base

Prices for Steps 1-4.

		N	A	E
FT142. 42	A	\$506	814	—
	B	\$506	814	814
46	A	\$508	818	—
	B	\$508	818	818
53	A	\$513	832	—
	B	\$513	832	832
57	A	\$517	847	—
	B	\$517	847	847
64	A	\$540	868	—
	B	\$540	868	868
68	A	\$565	889	—
	B	\$565	889	889
79	A	\$612	939	—
	B	\$612	939	939

Ceiling Power Entry, End of Run

continued

Step 5. Finish		
8Q	folkstone grey	+\$0
91	white	+\$0
98	studio white	+\$0
CL	cool grey neutral	+\$0
G1	graphite	+\$0
WL	sandstone	+\$0
WN	warm grey neutral	+\$0

Ceiling Power Entry, Connector FT143.

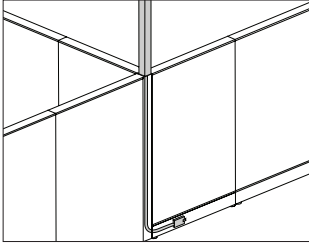

Canvas Office Landscape® Walls

Product Information

Description

This power entry connects a ceiling's electrical supply to the top of a 90° universal connector. It distributes up to 4 20-amp circuits. The power entry can be used with ceiling heights up to 10' and includes ceiling trim, connecting hardware, conduit, and a factory-installed electrical harness. The power entry plugs into the end of the harness; it does not connect into a receptacle location. The power entry is UL listed and Canadian UL listed.

Notes

Specify frame height of power entry to match highest frame at the connection.

Connector top cap is not required for connectors with a connector ceiling power entry.

Power harness must be used at a matching location of an adjacent frame (power locations A, C, and E).

Frame top screen (FT114.) cannot be used next to this power pole. For cable capacity information, see Cable Capacity Charts in Omni.

Dimensions

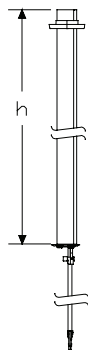
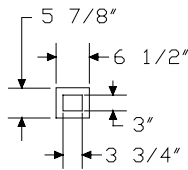

Specification Information

Step 1.

FT143.

Step 2. Frame Height

42	42" high
46	46" high
53	53" high
57	57" high
64	64" high
68	68" high
79	79" high A

Step 3. Power

N	nonpowered
A	4-circuit power connects above surface
C	4-circuit power connects below surface
E	4-circuit power connects in base

Prices for Steps 1-3.

	N	A	C	E
FT143. 42	\$745	1005	1005	1005
46	\$718	988	988	988
53	\$683	954	954	954
57	\$657	938	938	938
64	\$633	903	903	903
68	\$597	884	884	884
79	\$584	873	873	873

Step 4. Wiring Type

LZ	PVC-free			+\$0
-----------	----------	--	--	------

Step 5. Finish

8Q	folkstone grey			+\$0
98	studio white			+\$0
WL	sandstone			+\$0

Bright Sand Texture Paint

91	white			+\$0
CL	cool grey neutral			+\$0
G1	graphite			+\$0
WN	warm grey neutral			+\$0

Metallic Paint

CN	metallic champagne			+\$0
EH	metallic bronze			+\$0
MS	metallic silver			+\$0

Ceiling Power Entry, Architectural Trim, Connector FT14A.

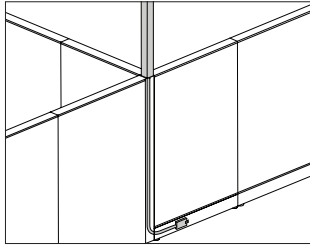

Product Information

Description

This power entry connects a ceiling's electrical supply to the top of a 90° universal connector. It distributes up to 4 20-amp circuits. The power entry can be used with ceiling heights up to 10' and includes ceiling trim, connecting hardware, conduit, and a factory-installed electrical harness. The power entry plugs into the end of the harness; it does not connect into a receptacle location. The power entry is UL listed and Canadian UL listed.

Notes

Specify height of power entry to match highest frame at the connection. Connector top cap is not required for connector with a connector ceiling power entry.

Power Entry can only be used with architectural connector covers and frame top caps.

Power harness must be used at a matching location of an adjacent frame (power locations A, C, and E).

Frame top screen (FT114.) cannot be used next to this power pole.

Dimensions

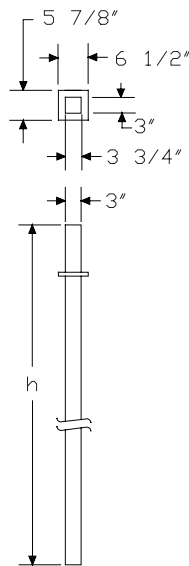

Specification Information

Step 1.

FT14A. [A]

Step 2. Frame Height

42	42" high	[A]
46	46" high	[A]
53	53" high	
57	57" high	[A]
64	64" high	
68	68" high	[A]
79	79" high	[A]

Step 3. Power

N	nonpowered	[A]
A	4-circuit power connects above surface	[A]
C	4-circuit power connects below surface	[A]
E	4-circuit power connects in base	[A]

Prices for Steps 1-3.

	N	A	C	E
FT14A. 42	\$1123	1276	1276	1276
46	\$1078	1237	1237	1237
53	\$1062	1225	1225	1225
57	\$1043	1200	1200	1200
64	\$1021	1174	1174	1174
68	\$1007	1166	1166	1166
79	\$973	1132	1132	1132

Step 4. Wiring Type

LZ	PVC-free			+\$0
-----------	----------	--	--	------

Step 5. Finish

8Q	folkstone grey			+\$0
98	studio white			+\$0
WL	sandstone			+\$0

Bright Sand Texture Paint

91	white	[A]		+\$0
CL	cool grey neutral	[A]		+\$0
G1	graphite	[A]		+\$0
WN	warm grey neutral	[A]		+\$0

Metallic Paint

CN	metallic champagne	[A]		+\$0
EH	metallic bronze	[A]		+\$0
MS	metallic silver	[A]		+\$0

Receptacle, 15 Amp (package of 6) FT155.

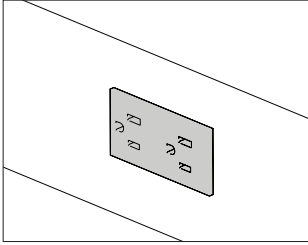

Product Information

Description

This receptacle locks into the power harness of a frame. Package contains 6 receptacles. It is UL listed and Canadian UL listed.

Dimensions

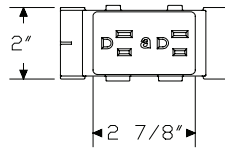
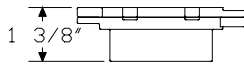

Duplex

Specification Information

Step 1.

FT155.

Step 2. Type

- A** duplex, circuit a
- B** duplex, circuit b
- C** duplex, circuit c
- DN** duplex, circuit d
- BI** duplex, circuit b, isolated ground
- CI** duplex, circuit c, isolated ground
- D** duplex, circuit d, isolated ground

Prices for Steps 1-2.

FT155. A	\$182
B	\$182
C	\$182
DN	\$182
BI	\$182
CI	\$182
D	\$182

Step 3. Finish

8Q folkstone grey	+\$0
91 white	+\$0
98 studio white	+\$0
CL cool grey neutral	+\$0
G1 graphite	+\$0
WL sandstone	+\$0
WN warm grey neutral	+\$0

Controlled Receptacle, 15 Amp FT155M
(package of 6)

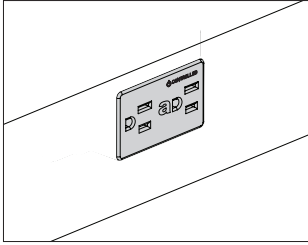

Product Information

Description

This receptacle is to be used for ASHRAE90.1 and Title 24 compliance. A controlled receptacle should be used for any receptacles that are under automated control by the energy management system. The receptacle locks into the power harness of a frame. Package contains 6 receptacles. It is UL listed and Canadian UL listed.

Dimensions

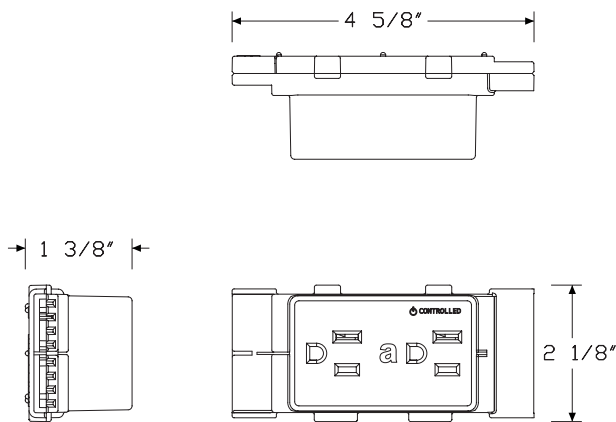

Specification Information

Step 1.

FT155M. A

Step 2. Type

- A** duplex, circuit a A
- B** duplex, circuit b A
- C** duplex, circuit c A
- DN** duplex, circuit d A
- BI** duplex, circuit b, isolated ground A
- CI** duplex, circuit c, isolated ground A
- D** duplex, circuit d, isolated ground A

Prices for Steps 1-2.

FT155M. A	\$182
B	\$182
C	\$182
DN	\$182
BI	\$182
CI	\$182
D	\$182

Step 3. Finish

8Q folkstone grey	+\$0
91 white	+\$0
98 studio white	+\$0
CL cool grey neutral	+\$0
G1 graphite	+\$0
WL sandstone	+\$0
WN warm grey neutral	+\$0

Receptacle, 4 Circuit, 20 Amp

FT156.

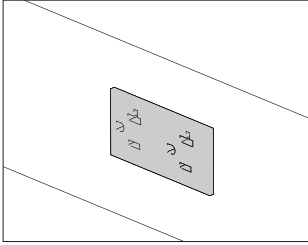

Canvas Office Landscape® Walls

Product Information

Description

This receptacle locks into a 4-circuit power harness to provide power to equipment with a 20-amp standard plug head or cap. It also accepts 15-amp standard plug heads or caps. The receptacle is UL listed; includes 1 receptacle.

Notes

Avoid overloading circuit by ensuring total connected load does not exceed 16 amps. If 1 piece of equipment requires all available power, do not use receptacle's second outlet or install additional receptacles on that circuit. In many cases, equipment requiring this receptacle will use all available power.

Dimensions

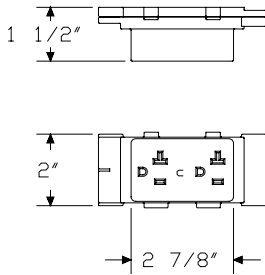

Specification Information

Step 1.

FT156.

Step 2. Type

AT	circuit a
BT	circuit b
CT	circuit c
DTN	circuit d
BIT	circuit b, isolated ground
CIT	circuit c, isolated ground
DT	circuit d, isolated ground

Prices for Steps 1-2.

FT156. AT	\$47
BT	\$47
CT	\$47
DTN	\$47
BIT	\$47
CIT	\$47
DT	\$47

Step 3. Finish

8Q	folkstone grey	+\$0
91	white	+\$0
98	studio white	+\$0
CL	cool grey neutral	+\$0
G1	graphite	+\$0
WL	sandstone	+\$0
WN	warm grey neutral	+\$0

Controlled Receptacle, 4-Circuit, FT156M 20 Amp

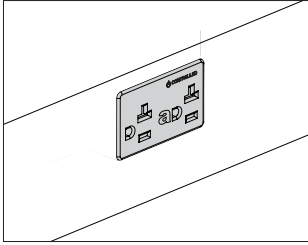

Product Information

Description

This receptacle is to be used for ASHRAE90.1 and Title 24 compliance. A controlled receptacle should be used for any receptacles that are under automated control by the energy management system. The receptacle locks into a 4-circuit power harness to provide power to equipment with a 20-amp standard plug head or cap. It also accepts 15-amp standard plug heads or caps. Package contains 1 receptacle. Receptacle is UL listed.

Notes

Avoid overloading circuit by ensuring total connected load does not exceed 16 amps. If 1 piece of equipment requires all available power, do not use receptacles second outlet or install additional receptacles on that circuit. In many cases, equipment requiring this receptacle will use all available power.

Dimensions

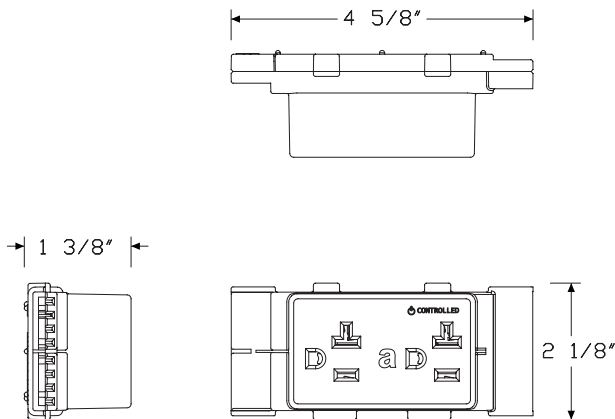

Specification Information

Step 1.

FT156M. A

Step 2. Type

AT	circuit a	<input type="checkbox"/> A
BT	circuit b	<input type="checkbox"/> A
CT	circuit c	<input type="checkbox"/> A
DTN	circuit d	<input type="checkbox"/> A
BIT	circuit b, isolated ground	<input type="checkbox"/> A
CIT	circuit c, isolated ground	<input type="checkbox"/> A
DT	circuit d, isolated ground	<input type="checkbox"/> A

Prices for Steps 1-2.

FT156M. AT	\$47
BT	\$47
CT	\$47
DTN	\$47
BIT	\$47
CIT	\$47
DT	\$47

Step 3. Finish

8Q	folkstone grey	+\$0
91	white	+\$0
98	studio white	+\$0
CL	cool grey neutral	+\$0
G1	graphite	+\$0
WL	sandstone	+\$0
WN	warm grey neutral	+\$0

Controlled Receptacle Decal
(12 per sheet)

G9999.

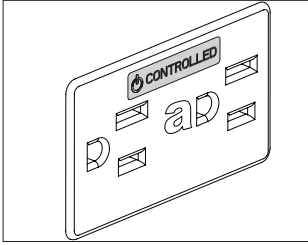

Canvas Office Landscape® Walls

Product Information

Description

This decal is to be used for ASHRAE90.1 and Title 24 compliance. The decal is used to mark standard receptacles (new or existing) that are under automated control by the energy management system. 1 sheet includes 12 clear decals with white or black print.

Dimensions

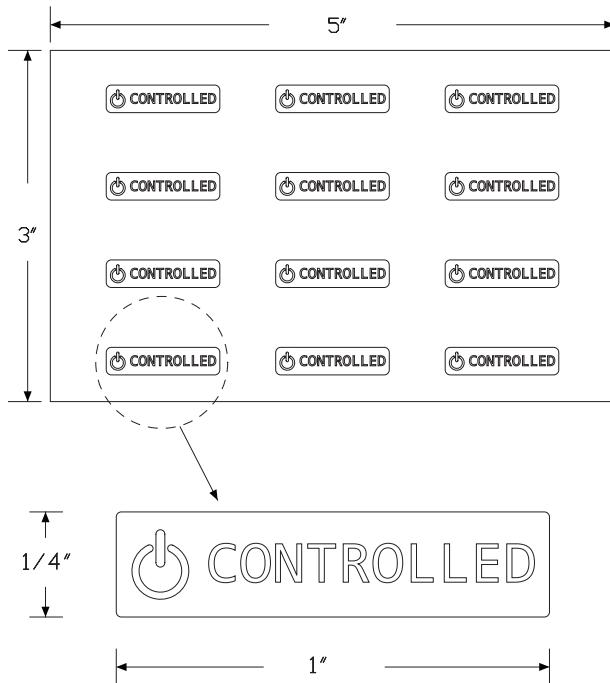

Specification Information

Step 1.

G9999. A

Step 2. Color

B black print A

W white print A

Prices for Steps 1-2.

G9999. B	\$8
W	\$8

Dual USB Charging Module, 2 Amp FT15U.

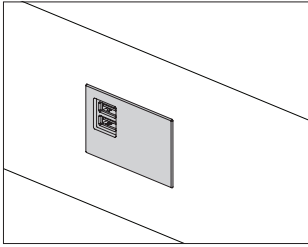

Product Information

Description

This dual USB charging module locks into the power harness of a Canvas frame. Total output for both USB ports combined is 10 watts. The charging module must be powered through circuit a.

Notes

The USB outlets can charge 2 devices, rated 2 amps (10 watts) or less, simultaneously. It can charge 1 tablet and 1 phone, or 2 phones. Maximum rating for both ports combined is 10 watts.

Dimensions

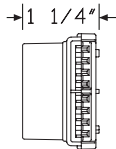
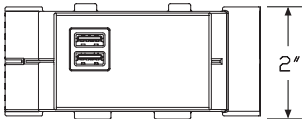
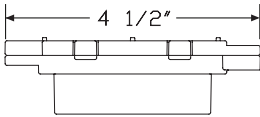

Specification Information

Step 1.

FT15U. A \$135

Step 2. Finish

8Q	folkstone grey	+\$0
91	white A	+\$0
98	studio white	+\$0
CL	cool grey neutral A	+\$0
G1	graphite A	+\$0
WL	sandstone	+\$0
WN	warm grey neutral A	+\$0

Cable Tray

FT193.

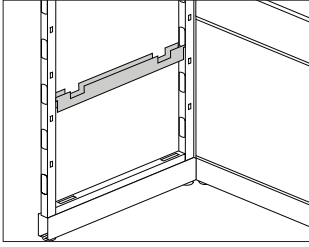

Canvas Office Landscape® Walls

Product Information

Description

This tray supports cables running horizontally within a frame. It spans the width of the frame and allows cables and power jumper to pass through the frame vertically. The cable tray is used at any 11"-high location along the frame.

Notes

Specify width of cable tray to match width of frame.

Cable tray is not required when routing cables horizontally in the base or top channel.

For cable capacity information, see Cable Capacity Charts in Omni.

Dimensions

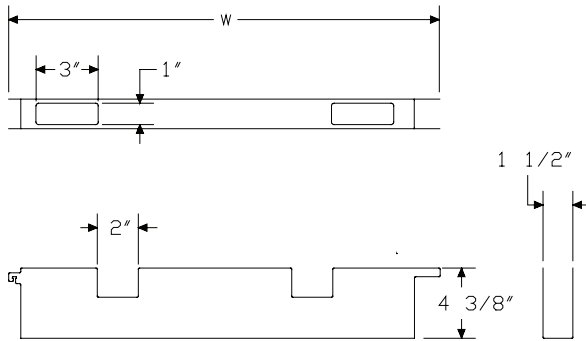

Specification Information

Step 1.

FT193.

Step 2. Width

- 18** 18" wide
- 24** 24" wide
- 30** 30" wide
- 36** 36" wide
- 42** 42" wide
- 48** 48" wide

Prices for Steps 1-2.

FT193. 18	\$45
24	\$49
30	\$51
36	\$54
42	\$57
48	\$60

Communication Port Faceplate Reducer

G1189.

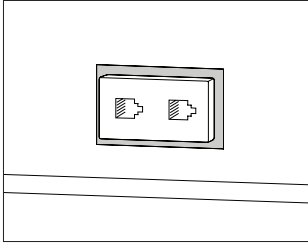

Product Information

Description

This faceplate fits into a communication port cutout and reduces the size of the cutout to fit specific telecommunications outlet/connector faceplates. Finish is black. Package contains 6.

Faceplate fits into the following communication port cutouts:

- Action Office® Series 2, or Ethospace® cable management side cover
- Action Office Series 2 cable management panel face
- Ethospace cable-access tile upper port
- Passage® data cover
- Canvas communication port cutouts

Notes

Purchase preconfigured voice/data outlets/connector faceplates separately from their manufacturers.

When specifying faceplate for Action Office Series 2 panel or Ethospace frame, order “J” or “G” power option with communication port locations.

When specifying faceplate for Action Office Series 2 cable management panel, order panel face side 1 (A1181.C) and side 2 (A1182.C) separately.

When specifying faceplate for Ethospace grooved face tile or frame with grooved side covers, order both reducer (G1189.A) and extender (G1189.B).

Dimensions

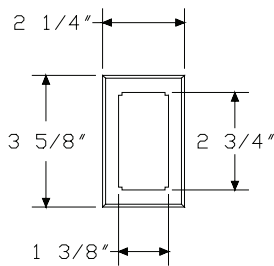

Specification Information

Step 1.

G1189.A

\$51

Frame Grommet

FT194.

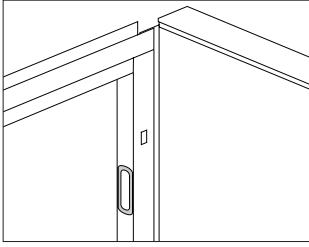

Canvas Office Landscape® Walls

Product Information

Description

This grommet is used inside a frame for extra protection when routing data cabling through openings in a frame. Package contains 12.

Dimensions

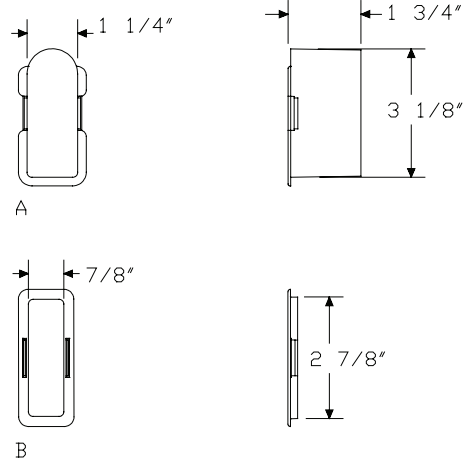

Specification Information

Step 1.

FT194.

Step 2. Usage

- A** for vertical frame stiles
- B** for horizontal frame rails

Prices for Steps 1-2.

FT194. A	\$54
B	\$54

Communication Port Faceplate Extender

G1189.

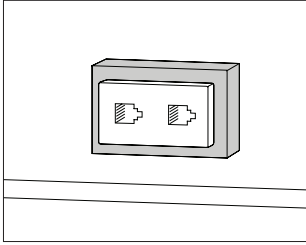

Product Information

Description

This faceplate fits over the communication port cutout of the following products: Action Office® Series 2 or Ethospace® cable management side cover; Action Office Series 2 cable management panel face; Ethospace cable access tile upper port; Resolve® data faceplate housing; or a Passage® voice/data outlet. It allows installation of specific cable communication modules without interfering with cable distribution capacity. Attachment hardware is included. Package contains 6.

Notes

Purchase preconfigured voice/data modules/faceplates separately from their manufacturers.

When specifying faceplate for Action Office Series 2 panel or Ethospace frame, order "J" or "G" power option with communication port locations.

When specifying faceplate for Action Office Series 2 cable management panel, order panel face side 1 (A1181.C) and side 2 (A1182.C) separately.

When specifying faceplate for Ethospace grooved face tile or frame with grooved side covers, order both reducer (G1189.A) and extender (G1189.B).

When specifying faceplate for Resolve data faceplate housing, order housing (R1360.) separately.

Dimensions

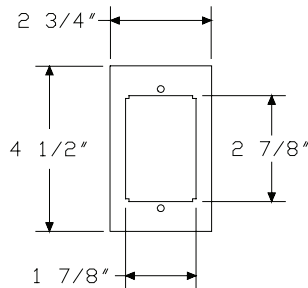

Specification Information

Step 1.

G1189.B \$64

Step 2. Surface Finish

8Q	folkstone grey	+\$0
91	white	+\$0
98	studio white <input type="checkbox"/> A	+\$0
BU	black umber	+\$0
CL	cool grey neutral	+\$0
G1	graphite	+\$0
HF	inner tone light	+\$0
LU	soft white	+\$0
MT	medium tone	+\$0
SG	slate grey	+\$0
WL	sandstone	+\$0
WN	warm grey neutral	+\$0

Cable Management Clips

FT198.

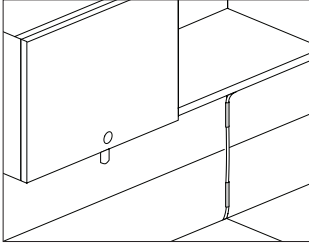

Canvas Office Landscape® Walls

Product Information

Description

These clips attach to a frame at an in-line connection, corner, or end of a frame run (90° and 120° applications) to vertically manage task light cables. At least 2 clips are recommended to manage cables from 1 task light to below a surface. Finish is black.

Notes

Clips are available in a package of 12 or 36.

Dimensions

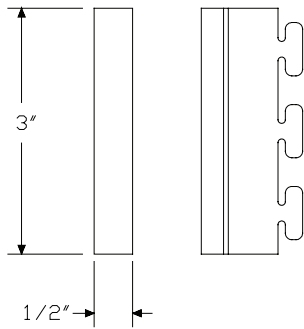
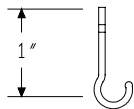

Specification Information

Step 1.

FT198.

Step 2. Quantity

12 12 clips

36 36 clips

Prices for Steps 1-2.

FT198. 12	\$53
36	\$144

Communication Faceplate
Extender

X1313.

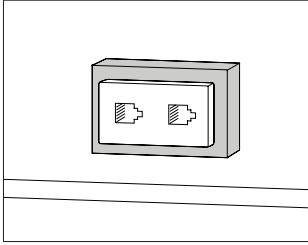

Product Information

Description

This faceplate fits over a Canvas communication port cutout. It allows installation of specific cable communication modules without reducing cable distribution capacity. The extender adds $\frac{3}{8}$ " of depth behind the communication module. Attachment hardware is included. Package contains 6.

Dimensions

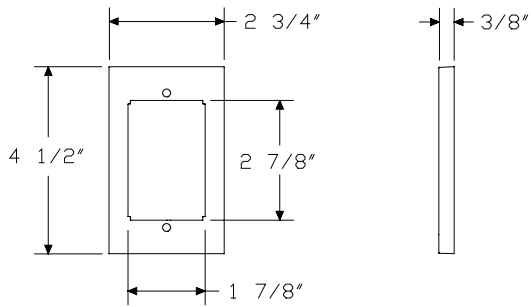

Specification Information

Step 1.

X1313. \$58

Step 2. Finish

8Q	folkstone grey	+\$0
91	white	+\$0
98	studio white	+\$0
CL	cool grey neutral	+\$0
G1	graphite	+\$0
WL	sandstone	+\$0
WN	warm grey neutral	+\$0

Full-Height Tile, Architectural

FT18A.

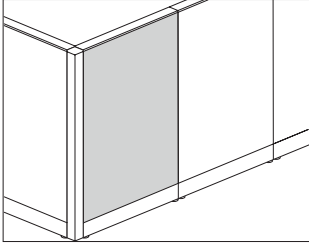

Canvas Office Landscape® Walls

Product Information

Description

This monolithic tile attaches to 1 side of a frame and has a tackable fabric surface. It extends the full height of a frame and ends 4" above the floor. It is UL listed and NFPA classified. Attachment hardware included.

Notes

Specify tile height as follows:

- For 42"-high frame, specify 37"-high (37) tile.
- For 46"-high frame, specify 41"-high (41) tile.
- For 53"-high frame, specify 48"-high (48) tile.
- For 57"-high frame, specify 52"-high (52) tile.
- For 68"-high frame, specify 63"-high (63) tile.

Specify width of tile to match width of frame.

When specifying tackable fabric, horizontal (R) option, fabric direction is horizontal (railroaded). Specify all tiles within the workstation the same. Fabric-covered tile accepts Customer's Own Material (COM). Yardage is estimated for directional, 54"-wide fabrics.

For tackable fabric option (T):

Height—Yardage

37"—1.26

41"—1.38

52"—1.70

63"—2.00

For tackable fabric, horizontal option (R):

Width—Yardage

24"—0.88

30"—1.05

36"—1.22

42"—1.40

48"—1.58

For information on multiple quantities or nondirectional fabrics, contact COM Department. See Order Information in appendices.

Dimensions

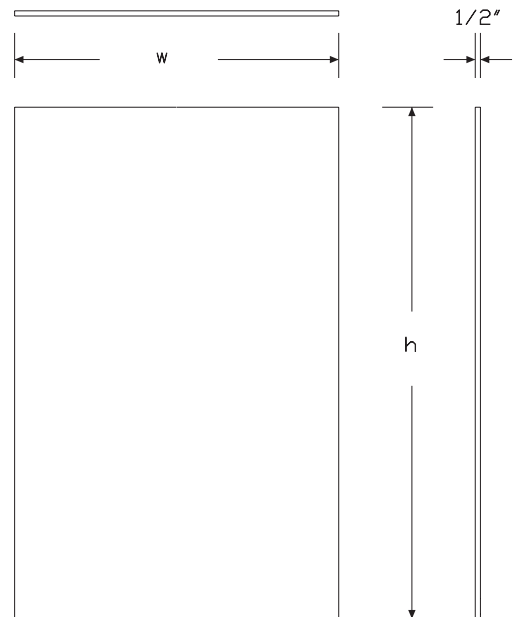

Full-Height Tile, Architectural

continued

Specification Information

Step 1.

FT18A.

Step 2. Height

37	37" high
41	41" high
48	48" high
52	52" high
63	63" high

Step 3. Width

18	18" wide
24	24" wide
30	30" wide
36	36" wide
42	42" wide
48	48" wide

Step 4. Surface Material

For 37" high (37) or 41" high (41)

T	tackable fabric
R	tackable fabric, horizontal

For 48" high (48), 52" high (52), or 63" high (63)

T	tackable fabric
----------	-----------------

Prices for Steps 1-4.

	T	R
FT18A. 37 18	\$126	135
24	\$136	139
30	\$144	148
36	\$177	181
42	\$188	192
48	\$197	202
41 18	\$141	138
24	\$142	147
30	\$155	158
36	\$189	193
42	\$201	209
48	\$214	221

48 18	\$139	—
24	\$144	—
30	\$159	—
36	\$199	—
42	\$211	—
48	\$222	—
52 18	\$150	—
24	\$163	—
30	\$179	—
36	\$224	—
42	\$235	—
48	\$253	—
63 18	\$169	—
24	\$183	—
30	\$201	—
36	\$255	—
42	\$274	—
48	\$291	—

Step 5. Fabric

	37T	37R	41T	41R	48T
Price Category 1	+\$0	0	0	0	0
Price Category 2	+\$22	22	25	25	27
Price Category 3	+\$39	39	42	42	46
Price Category 4	+\$60	60	66	66	74
Price Category 5	+\$124	124	136	136	151
Price Category B	+\$63	63	69	69	77
Price Category C	+\$94	94	103	103	110
Price Category D	+\$124	124	136	136	139
Price Category E	+\$154	154	169	169	168
Price Category F	+\$207	207	227	227	217
Price Category G	+\$269	269	294	294	299
				52T	63T
Price Category 1				+\$0	0
Price Category 2				+\$31	37
Price Category 3				+\$51	59
Price Category 4				+\$82	97
Price Category 5				+\$169	203
Price Category B				+\$85	102
Price Category C				+\$129	153
Price Category D				+\$169	203
Price Category E				+\$212	252
Price Category F				+\$279	328
Price Category G				+\$363	427

Full-Height Tile

FT180.

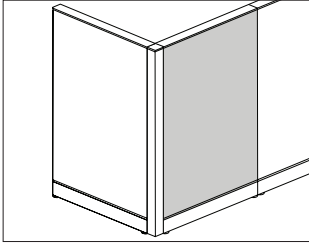

Canvas Office Landscape® Walls

Product Information

Description

This monolithic tile attaches to 1 side of a frame and has a tackable fabric, laminate, or veneer surface. It extends the full height of a frame and ends 4" from the floor. It has a horizontal bead along the top of the tile and is UL listed and NFPA classified. Attachment hardware included.

Notes

Specify tile height as follows:

- For 42"-high frame, specify 37"-high tile
- For 46"-high frame, specify 41"-high tile
- For 53"-high frame, specify 48"-high tile
- For 57"-high frame, specify 52"-high tile
- For 68"-high frame, specify 63"-high tile

Specify width of tile to match width of frame.

When specifying tackable fabric, horizontal option (R), fabric direction is horizontal (railroaded). Specify all tiles within the workstation the same. Fabric-covered tile accepts Customer's Own Material (COM). Yardage is estimated for directional, 54"-wide fabrics.

For tackable fabric option (T)

Height—Yardage

37"—1.26

41"—1.38

52"—1.70

63"—2.00

For tackable fabric, horizontal option (R)

Width—Yardage

24"—.88

30"—1.05

36"—1.22

42"—1.4

48"—1.58

For information on multiple quantities or nondirectional fabrics, contact COM Department. See Order Information in Appendices.

Dimensions

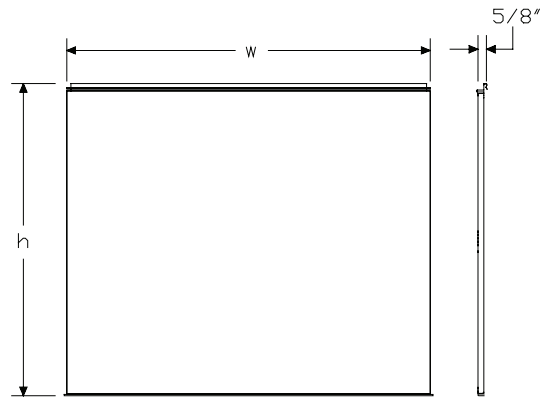

Full-Height Tile *continued*

Specification Information

Step 1.

FT180.

Step 2. Height

37	37" high
41	41" high
48	48" high
52	52" high
63	63" high

Step 3. Width

18	18" wide
24	24" wide
30	30" wide
36	36" wide
42	42" wide
48	48" wide

Step 4. Surface Material

For 37" high (37) or 41" high (41)

T	tackable fabric
W	veneer A
L	laminate
R	tackable fabric, horizontal

For 48" high (48), 52" high (52), or 63" high (63)

T	tackable fabric
----------	-----------------

Prices for Steps 1-4.

	T	W	L	R
FT180. 37 18	\$126	506	392	135
24	\$136	591	424	139
30	\$144	675	465	148
36	\$177	759	495	181
42	\$188	832	527	192
48	\$197	902	568	202
41 18	\$141	579	413	138
24	\$142	615	439	147
30	\$155	701	480	158
36	\$189	789	523	193
42	\$201	876	565	209
48	\$214	962	606	221

48 18	\$139	—	—	—
24	\$144	—	—	—
30	\$159	—	—	—
36	\$199	—	—	—
42	\$211	—	—	—
48	\$222	—	—	—
52 18	\$150	—	—	—
24	\$163	—	—	—
30	\$179	—	—	—
36	\$224	—	—	—
42	\$235	—	—	—
48	\$253	—	—	—
63 18	\$169	—	—	—
24	\$183	—	—	—
30	\$201	—	—	—
36	\$255	—	—	—
42	\$274	—	—	—
48	\$291	—	—	—

Step 5. Surface Finish

For veneer (W)

2U	light brown walnut A	+\$0
40	dark brown walnut	+\$0
ED	aged cherry A	+\$0
EK	medium red walnut	+\$0
EW	medium matte walnut	+\$0
ET	clear on ash A	+\$0
EU	oak on ash A	+\$0
EV	walnut on ash A	+\$0
UL	natural maple A	+\$0
UX	walnut on cherry A	+\$0

For laminate (L)

8Q	folkstone grey	+\$0
91	white	+\$0
LU	soft white	+\$0
WL	sandstone	+\$0

Full-Height Tile *continued*

Step 6. Horizontal Bead Finish		
8Q	folkstone grey	+\$0
91	white	+\$0
CL	cool grey neutral	+\$0
G1	graphite	+\$0
LU	soft white	+\$0
MT	medium tone	+\$0
WL	sandstone	+\$0
WN	warm grey neutral	+\$0
CN	metallic champagne	+\$0
EH	metallic bronze	+\$0
MS	metallic silver	+\$0

Step 7. Fabric
*See application chart and textiles list for fabric usage and numbers.
 First 2 digits of number indicate fabric line; remaining digit(s) indicate fabric color.*

For tackable fabric (T) AND tackable fabric, horizontal (R)					
	37	41	48	52	63
Price Category 1	+\$0	0	0	0	0
Price Category 2	+\$22	25	27	31	37
Price Category 3	+\$39	42	46	51	59
Price Category 4	+\$60	66	74	82	97
Price Category 5	+\$124	136	151	169	203
Price Category B	+\$63	69	77	85	102
Price Category C	+\$94	103	110	129	153
Price Category D	+\$124	136	139	169	203
Price Category E	+\$154	169	168	212	252
Price Category F	+\$207	227	217	279	328
Price Category G	+\$269	294	299	363	427

Extended-Width Full Height Tile FT380.

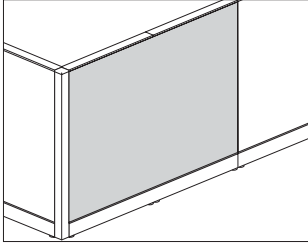

Product Information

Description

This monolithic tile covers 1 side of 2 adjacent frames up to 46" high. It has a tackable fabric, laminate, or veneer surface with a horizontal bead along the top. The tile is UL listed and NFPA classified. Attachment hardware included.

Notes

Specify tile height as follows:

- For 42"-high frame, specify 37"-high tile
- For 46"-high frame, specify 41"-high tile

Specify width of tile to match the combined width of 2 frames.

When specifying tackable fabric, horizontal option (R), fabric direction is horizontal (railroaded). Specify all tiles within the workstation the same. Fabric-covered tile accepts Customer's Own Material (COM). Yardage is estimated for directional, 54"-wide fabrics.

Width—Yardage

- 54" —1.75
- 60" —1.93
- 66" —2.11
- 72" —2.29
- 78" —2.47
- 84" —2.65
- 90" —2.83
- 96" —3.01

For information on multiple quantities or nondirectional fabrics, contact COM Department. See Order Information in Appendices.

Dimensions

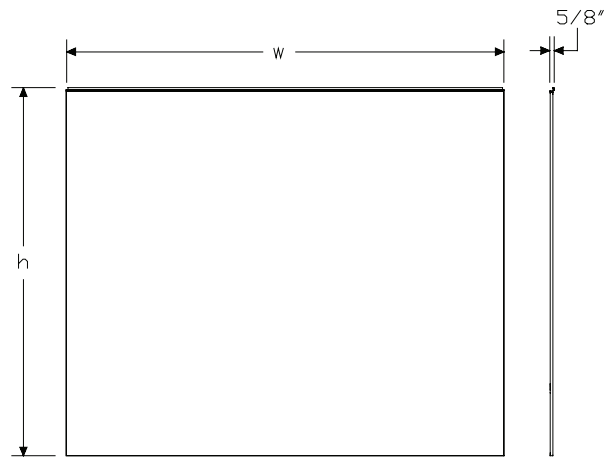

Extended-Width Full Height Tile

continued

Specification Information					
Step 1.					
FT380.					
Step 2. Height					
37	37" high				
41	41" high				
Step 3. Width					
54	54" wide				
60	60" wide				
66	66" wide				
72	72" wide				
78	78" wide				
84	84" wide				
90	90" wide				
96	96" wide				
Step 4. Surface Material					
<i>For 37" high (37)</i>					
R	tackable fabric, horizontal				
<i>For 41" high (41)</i>					
R	tackable fabric, horizontal				
L	laminate				
W	veneer <input type="checkbox"/> A				
Prices for Steps 1-4.					
		R	L	W	
FT380.	37	54	\$268	—	—
		60	\$278	—	—
		66	\$310	—	—
		72	\$342	—	—
		78	\$370	—	—
		84	\$381	—	—
		90	\$391	—	—
		96	\$401	—	—
	41	54	\$286	788	937
		60	\$297	814	1099
		66	\$333	893	1227
		72	\$369	933	1299
		78	\$396	1065	1504
		84	\$410	1104	1590
		90	\$420	1148	1667
		96	\$432	1178	1743

Step 5. Frame Configuration		
<i>For 54" wide (54)</i>		
F0	1 30"-wide frame, 1 24"-wide frame	+\$0
<i>For 60" wide (60)</i>		
H0	2 30"-wide frames	+\$0
J0	1 36"-wide frame, 1 24"-wide frame	+\$0
<i>For 66" wide (66)</i>		
K0	1 36"-wide frame, 1 30"-wide frame	+\$0
L0	1 42"-wide frame, 1 24"-wide frame	+\$0
<i>For 72" wide (72)</i>		
M0	2 36"-wide frames	+\$0
P0	1 42"-wide frame, 1 30"-wide frame	+\$0
S0	1 48"-wide frame, 1 24"-wide frame	+\$0
<i>For 78" wide (78)</i>		
U0	1 42"-wide frame, 1 36"-wide frame	+\$0
V0	1 48"-wide frame, 1 30"-wide frame	+\$0
<i>For 84" wide (84)</i>		
X0	2 42"-wide frames	+\$0
Z0	1 48"-wide frame, 1 36"-wide frame	+\$0
<i>For 90" wide (90)</i>		
40	1 48"-wide frame, 1 42"-wide frame	+\$0
<i>For 96" wide (96)</i>		
50	2 48"-wide frames	+\$0
Step 6. Surface Finish		
<i>For laminate (L)</i>		
8Q	folkstone grey	+\$0
91	white	+\$0
LU	soft white	+\$0
WL	sandstone	+\$0

Extended-Width Full Height Tile

continued

For veneer (W)

2U	light brown walnut <input type="checkbox"/> A	+\$0
40	dark brown walnut	+\$0
ED	aged cherry <input type="checkbox"/> A	+\$0
EK	medium red walnut	+\$0
EW	medium matte walnut	+\$0
ET	clear on ash <input type="checkbox"/> A	+\$0
EU	oak on ash <input type="checkbox"/> A	+\$0
EV	walnut on ash <input type="checkbox"/> A	+\$0
UL	natural maple <input type="checkbox"/> A	+\$0
UX	walnut on cherry <input type="checkbox"/> A	+\$0

Step 7. Horizontal Bead Finish

8Q	folkstone grey	+\$0
91	white	+\$0
98	studio white	+\$0
CL	cool grey neutral	+\$0
G1	graphite	+\$0
LU	soft white	+\$0
MT	medium tone	+\$0
WL	sandstone	+\$0
WN	warm grey neutral	+\$0
CN	metallic champagne	+\$0
EH	metallic bronze	+\$0
MS	metallic silver	+\$0

Step 8. Fabric

For tackable fabric, horizontal (R)

	37	41
Price Category 1	+\$0	0
Price Category 2	+\$44	49
Price Category 3	+\$76	83
Price Category 4	+\$119	131
Price Category 5	+\$248	272
Price Category B	+\$125	137
Price Category C	+\$187	204
Price Category D	+\$246	270
Price Category E	+\$308	337
Price Category F	+\$451	495
Price Category G	+\$230	230

To-The-Floor Full-Height Tile

FT385.

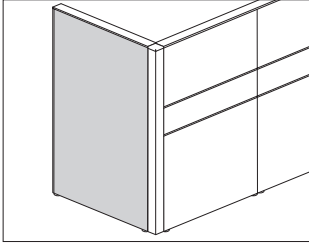

Canvas Office Landscape® Walls

Product Information

Description

This monolithic tile covers 1 side of a frame and extends to the floor, concealing the base and eliminating the need for a base cover. It has a tackable fabric, laminate or veneer surface with a horizontal bead along the top. The tile is UL listed and NFPA classified. Light seals and attachment hardware included.

Notes

Tile is designed to be used on frame with no base covers (FT110.xxxxX). Specify width of tile to match width of frame. Specify height of tile to match height of frame.

Tackable tiles include base stiffener kit.

When specifying tackable fabric, horizontal option (R), fabric direction is horizontal (railroaded). Specify all tiles within the workstation the same. Fabric-covered tile accepts Customer's Own Material (COM). Yardage is estimated for directional, 54"-wide fabrics.

For tackable fabric option (T)

Height—Yardage

42"—1.3

46"—1.4

57"—1.72

68"—2.04

For tackable fabric, horizontal option (R)

Width—Yardage

24"—.88

30"—1.05

36"—1.22

42"—1.4

48"—1.58

For information on multiple quantities or nondirectional fabrics, contact COM Department. See Order Information in Appendices.

Dimensions

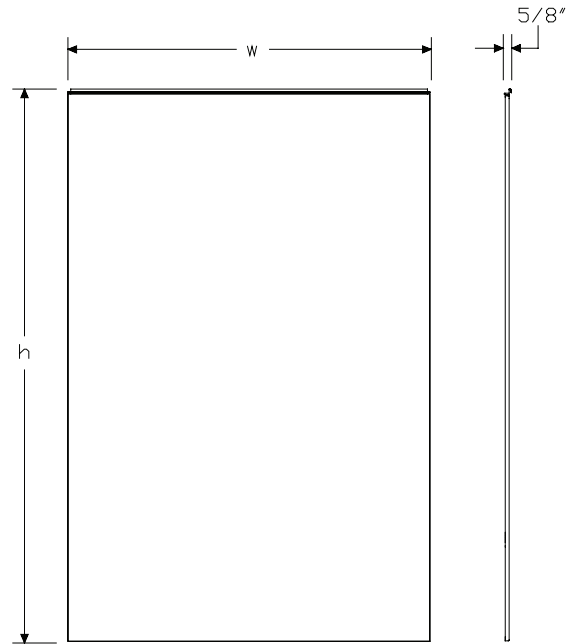

To-The-Floor Full-Height Tile

continued

Specification Information

Step 1.

FT385.

Step 2. Height

42	42" high
46	46" high
53	53" high
57	57" high
68	68" high

Step 3. Width

18	18" wide
24	24" wide
30	30" wide
36	36" wide
42	42" wide
48	48" wide

Step 4. Surface Material

For 42" high (42) or 46" high (46)

T	tackable fabric
R	tackable fabric, horizontal
L	laminate
W	veneer A

For 53" high (53), 57" high (57), or 68" high (68)

T	tackable fabric
----------	-----------------

Prices for Steps 1-4.

	T	R	L	W
FT385. 42 18	\$179	202	415	569
24	\$184	209	440	603
30	\$193	220	480	684
36	\$223	252	522	777
42	\$235	265	562	858
48	\$244	273	602	939
46 18	\$187	213	470	574
24	\$192	219	494	622
30	\$202	229	539	704
36	\$237	266	581	788
42	\$248	277	626	872
48	\$257	290	670	955

53 18	\$193	—	—	—
24	\$205	—	—	—
30	\$216	—	—	—
36	\$252	—	—	—
42	\$264	—	—	—
48	\$274	—	—	—
57 18	\$226	—	—	—
24	\$230	—	—	—
30	\$243	—	—	—
36	\$283	—	—	—
42	\$294	—	—	—
48	\$310	—	—	—
68 18	\$255	—	—	—
24	\$262	—	—	—
30	\$277	—	—	—
36	\$326	—	—	—
42	\$344	—	—	—
48	\$358	—	—	—

Step 5. Surface Finish

For laminate (L)

8Q	folkstone grey	+\$0
91	white	+\$0
LU	soft white	+\$0
WL	sandstone	+\$0

For veneer (W)

2U	light brown walnut A	+\$0
40	dark brown walnut	+\$0
ED	aged cherry A	+\$0
EK	medium red walnut	+\$0
EW	medium matte walnut	+\$0
ET	clear on ash A	+\$0
EU	oak on ash A	+\$0
EV	walnut on ash A	+\$0
UL	natural maple A	+\$0
UX	walnut on cherry A	+\$0

To-The-Floor Full-Height Tile

continued

Canvas Office Landscape® Walls

Step 6. Horizontal Bead Finish		
8Q	folkstone grey	+\$0
91	white	+\$0
98	studio white	+\$0
CL	cool grey neutral	+\$0
G1	graphite	+\$0
LU	soft white	+\$0
MT	medium tone	+\$0
WL	sandstone	+\$0
WN	warm grey neutral	+\$0
CN	metallic champagne	+\$0
EH	metallic bronze	+\$0
MS	metallic silver	+\$0

Step 7. Fabric

<i>For tackable fabric (T) AND tackable fabric, horizontal (R)</i>					
	42	46	53	57	68
Price Category 1	+\$0	0	0	0	0
Price Category 2	+\$25	31	31	31	37
Price Category 3	+\$42	51	51	51	59
Price Category 4	+\$66	82	82	82	97
Price Category 5	+\$136	169	169	169	203
Price Category B	+\$69	85	85	85	102
Price Category C	+\$103	129	129	129	150
Price Category D	+\$136	169	147	169	190
Price Category E	+\$169	212	178	212	230
Price Category F	+\$248	311	230	311	297
Price Category G	+\$230	230	230	230	230

To-The-Floor Extended-Width Full-Height Tile FT386.

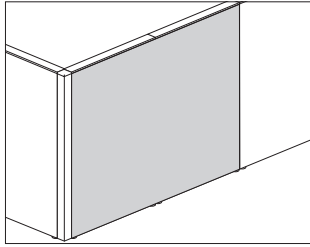

Product Information

Description

This monolithic tile covers 1 side of 2 adjacent frames up to 46" high and extends to the floor. It conceals the bases and eliminates the need for base covers on that side. It has a tackable fabric, laminate or veneer surface with a horizontal bead along the top. The tile is UL listed and NFPA classified. Attachment hardware included.

Notes

Tile is designed to be used on frame with no base covers (FT110.xxxxX). Specify width of tile to match the combined width of 2 frames. Specify height of tile to match height of frame.

When specifying tackable fabric, horizontal option (R), fabric direction is horizontal (railroaded). Specify all tiles within the workstation the same. Fabric-covered tile accepts Customer's Own Material (COM). Yardage is estimated for directional, 54"-wide fabrics.

Width—Yardage

- 54" —1.75
- 60" —1.93
- 66" —2.11
- 72" —2.29
- 78" —2.47
- 84" —2.65
- 90" —2.83
- 96" —3.01

For information on multiple quantities or nondirectional fabrics, contact COM Department. See Order Information in Appendices.

Dimensions

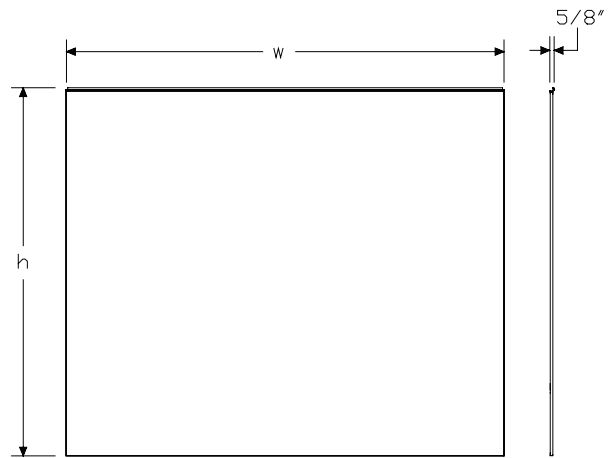

To-The-Floor Extended-Width Full-Height Tile *continued*

Specification Information

Step 1.

FT386.

Step 2. Height

42	42" high
46	46" high

Step 3. Width

54	54" wide
60	60" wide
66	66" wide
72	72" wide
78	78" wide
84	84" wide
90	90" wide
96	96" wide

Step 4. Surface Material

For 42" high (42)

R tackable fabric, horizontal

For 46" high (46)

R tackable fabric, horizontal

L laminate

W veneer A

Prices for Steps 1-4.

		R	L	W
FT386. 42	54	\$381	—	—
	60	\$391	—	—
	66	\$419	—	—
	72	\$449	—	—
	78	\$461	—	—
	84	\$474	—	—
	90	\$482	—	—
	96	\$490	—	—
46	54	\$397	928	1215
	60	\$409	967	1386
	66	\$442	1005	1460
	72	\$476	1045	1514
	78	\$487	1084	1665
	84	\$496	1124	1771
	90	\$509	1163	1814
	96	\$518	1203	1911

Step 5. Frame Configuration

For 54" wide (54)

F0 1 30"-wide frame, 1 24"-wide frame +\$0

For 60" wide (60)

H0 2 30"-wide frames +\$0

J0 1 36"-wide frame, 1 24"-wide frame +\$0

For 66" wide (66)

K0 1 36"-wide frame, 1 30"-wide frame +\$0

L0 1 42"-wide frame, 1 24"-wide frame +\$0

For 72" wide (72)

M0 2 36"-wide frames +\$0

P0 1 42"-wide frame, 1 30"-wide frame +\$0

S0 1 48"-wide frame, 1 24"-wide frame +\$0

For 78" wide (78)

U0 1 42"-wide frame, 1 36"-wide frame +\$0

V0 1 48"-wide frame, 1 30"-wide frame +\$0

For 84" wide (84)

X0 2 42"-wide frames +\$0

Z0 1 48"-wide frame, 1 36"-wide frame +\$0

For 90" wide (90)

40 1 48"-wide frame, 1 42"-wide frame +\$0

For 96" wide (96)

50 2 48"-wide frames +\$0

Step 6. Surface Finish

For laminate (L)

8Q folkstone grey +\$0

91 white +\$0

LU soft white +\$0

WL sandstone +\$0

To-The-Floor Extended-Width Full-Height Tile *continued*

For veneer (W)

2U	light brown walnut <input type="checkbox"/> A	+\$0
40	dark brown walnut	+\$0
ED	aged cherry <input type="checkbox"/> A	+\$0
EK	medium red walnut	+\$0
EW	medium matte walnut	+\$0
ET	clear on ash <input type="checkbox"/> A	+\$0
EU	oak on ash <input type="checkbox"/> A	+\$0
EV	walnut on ash <input type="checkbox"/> A	+\$0
UL	natural maple <input type="checkbox"/> A	+\$0
UX	walnut on cherry <input type="checkbox"/> A	+\$0

Step 7. Horizontal Bead Finish

91	white	+\$0
98	studio white	+\$0
CL	cool grey neutral	+\$0
G1	graphite	+\$0
LU	soft white	+\$0
MT	medium tone	+\$0
WL	sandstone	+\$0
WN	warm grey neutral	+\$0
CN	metallic champagne	+\$0
EH	metallic bronze	+\$0
MS	metallic silver	+\$0

Step 8. Fabric

For tackable fabric, horizontal (R)

	42	46
Price Category 1	+\$0	0
Price Category 2	+\$49	61
Price Category 3	+\$83	101
Price Category 4	+\$131	163
Price Category 5	+\$272	337
Price Category B	+\$91	98
Price Category C	+\$125	135
Price Category D	+\$158	170
Price Category E	+\$191	206
Price Category F	+\$246	266
Price Category G	+\$230	230

Lower Tile

FT170.

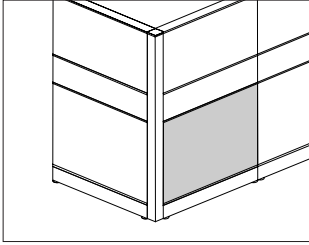

Canvas Office Landscape® Walls

Product Information

Description

This tile attaches to 1 side of a frame or to wall strips and has a painted, tackable fabric, veneer, or debossed metal surface. The lower tile zone is 30" high and can be covered with a 30" tile or a combination of an 11" and 19" tile. Each tile has a horizontal bead along the top of the tile. The tile is UL listed and NFPA classified. Attachment hardware is included.

Notes

Specify width of tile to match width of frame.

When using combination of 11"- and 19"-high tiles, 19"-high tile is in the lowest position.

When specifying tackable fabric, horizontal option (R), fabric direction is horizontal (railroaded). Specify all tiles within the workstation the same. Fabric-covered tile accepts Customer's Own Material (COM). Yardage is estimated for directional, 54"-wide fabrics.

For tackable fabric option (T)

Height—Yardage

11"—0.50

19"—0.74

30"—1.06

For tackable fabric, horizontal option (R)

Width—Yardage

24"—.88

30"—1.05

36"—1.22

42"—1.4

48"—1.58

For information on multiple quantities or nondirectional fabrics, contact COM Department. See Order Information in Appendices.

Dimensions

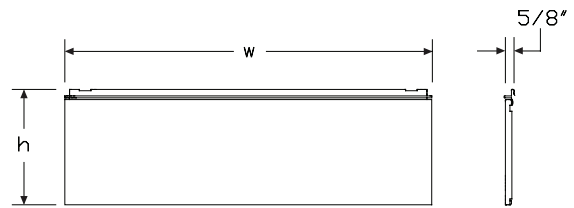

Painted, Fabric, Laminate, Veneer

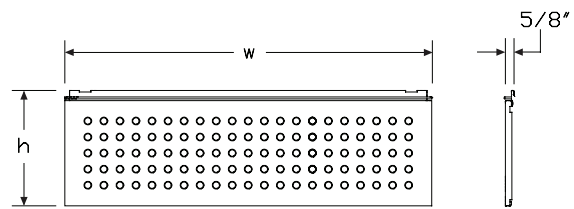

Debossed

Specification Information

Step 1.

FT170.

Step 2. Height

- 11** 11" high
- 19** 19" high
- 30** 30" high

Step 3. Width

- 18** 18" wide
- 24** 24" wide
- 30** 30" wide
- 36** 36" wide
- 42** 42" wide
- 48** 48" wide

Step 4. Surface Material

- P** painted
- T** tackable fabric
- W** veneer A
- X** debossed
- L** laminate
- R** tackable fabric, horizontal

Prices for Steps 1-4.

	P	T	W	X	L	R
FT170. 11 18	\$51	71	273	87	237	74
24	\$53	74	280	89	243	77
30	\$56	80	296	96	256	83
36	\$59	86	315	105	272	90
42	\$62	93	331	113	286	95
48	\$65	97	349	120	300	100
19 18	\$71	96	381	119	318	99
24	\$73	100	388	121	330	103
30	\$78	111	417	130	352	113
36	\$83	118	445	139	372	123
42	\$88	128	473	149	392	134
48	\$93	137	501	158	414	140
30 18	\$92	128	465	149	365	134
24	\$95	134	489	154	376	137
30	\$101	141	542	166	403	146
36	\$110	153	591	179	434	156
42	\$116	161	643	191	462	166
48	\$122	171	694	204	490	177

Step 5. Surface Finish

Sand Texture Paint

For painted (P) or debossed (X)

- 98** studio white A +\$0
- 8Q** folkstone grey A +\$0
- WL** sandstone A +\$0

Bright Sand Texture Paint

For painted (P) or debossed (X)

- 91** white +\$0
- CL** cool grey neutral +\$0
- G1** graphite +\$0
- WN** warm grey neutral +\$0

Metallic Paint

For painted (P) or debossed (X)

- CN** metallic champagne +\$0
- EH** metallic bronze +\$0
- MS** metallic silver +\$0

Wood Veneer

For veneer (W)

- 2U** light brown walnut A +\$0
- 40** dark brown walnut +\$0
- ED** aged cherry A +\$0
- EK** medium red walnut +\$0
- EW** medium matte walnut +\$0
- ET** clear on ash A +\$0
- EU** oak on ash A +\$0
- EV** walnut on ash A +\$0
- UL** natural maple A +\$0
- UX** walnut on cherry A +\$0

For laminate (L)

- 8Q** folkstone grey +\$0
- 91** white +\$0
- LU** soft white +\$0
- WL** sandstone +\$0

Lower Tile *continued*

Step 6. Horizontal Bead Finish		
8Q	folkstone grey	+\$0
91	white	+\$0
CL	cool grey neutral	+\$0
G1	graphite	+\$0
LU	soft white	+\$0
MT	medium tone	+\$0
WL	sandstone	+\$0
WN	warm grey neutral	+\$0
CN	metallic champagne	+\$0
EH	metallic bronze	+\$0
MS	metallic silver	+\$0

Step 7. Surface Finish
 See application chart and textiles list for fabric usage and numbers.
 First 2 digits of number indicate fabric line; remaining digit(s) indicate fabric color.

For tackable fabric (T) AND tackable fabric, horizontal (R)			
	11	19	30
Price Category 1	+\$0	0	0
Price Category 2	+\$7	13	19
Price Category 3	+\$13	21	33
Price Category 4	+\$18	33	51
Price Category 5	+\$43	69	103
Price Category B	+\$22	35	52
Price Category C	+\$33	52	79
Price Category D	+\$43	69	103
Price Category E	+\$54	84	128
Price Category F	+\$80	122	174
Price Category G	+\$107	158	226

For 19" high (19) with tackable fabric, horizontal (R)	
Price Category 1	+\$0
Price Category 2	+\$13
Price Category 3	+\$21
Price Category 4	+\$33
Price Category 5	+\$69
Price Category B	+\$35
Price Category C	+\$52
Price Category D	+\$69
Price Category E	+\$84
Price Category F	+\$122

Extended-Width Lower Tile

FT370.

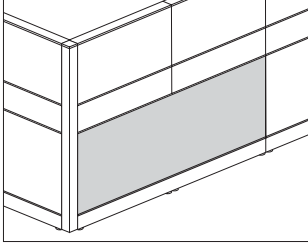

Product Information

Description

This tile attaches to 1 side of 2 adjacent frames to cover the lower zone. It has a tackable fabric, laminate, or veneer surface with a horizontal bead along the top. The tile is UL listed and NFPA classified. Attachment hardware included.

Notes

Specify width of tile to match the combined width of 2 frames.
When specifying tackable fabric, horizontal option (R), fabric direction is horizontal (railroaded). Specify all tiles within the workstation the same.
When using combination of 11"- and 19"-high lower tiles, 19"-high tile is in the lowest position.
Fabric-covered tile accepts Customer's Own Material (COM). Yardage is estimated for directional, 54"-wide fabrics.

Width—Yardage

54" — 1.75

60" — 1.93

66" — 2.11

72" — 2.29

78" — 2.47

84" — 2.65

90" — 2.83

96" — 3.01

Yardage for 54"-wide fabric covers up to 3 11"-high tiles, 2 19"-high tiles, or 1 30"-high tile.

For information on additional quantities or nondirectional fabrics, contact COM Department. See Order Information in Appendices.

Dimensions

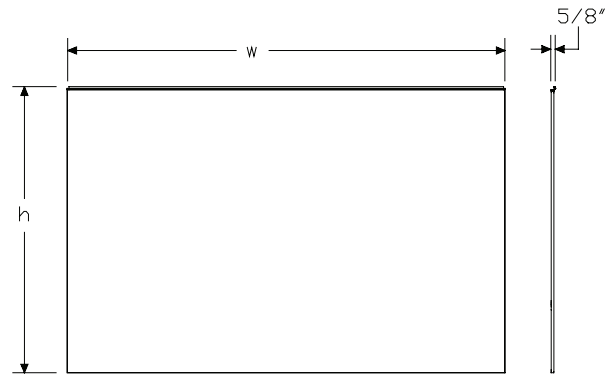

Specification Information

Step 1.

FT370.

Step 2. Height

11	11" high
19	19" high
30	30" high

Step 3. Width

54	54" wide
60	60" wide
66	66" wide
72	72" wide
78	78" wide
84	84" wide
90	90" wide
96	96" wide

Step 4. Surface Material

R	tackable fabric, horizontal
L	laminate
W	veneer A

Prices for Steps 1-4.

		R	L	W
FT370. 11	54	\$151	406	482
	60	\$155	416	507
	66	\$162	450	549
	72	\$169	465	564
	78	\$174	524	640
	84	\$179	539	656
	90	\$186	553	670
	96	\$191	568	691
19	54	\$196	553	687
	60	\$211	573	712
	66	\$224	617	773
	72	\$233	637	798
	78	\$240	720	911
	84	\$248	741	937
	90	\$257	750	967
	96	\$264	775	992

30	54	\$257	637	879
	60	\$275	656	927
	66	\$286	715	1018
	72	\$297	741	1064
	78	\$306	843	1223
	84	\$315	869	1273
	90	\$324	897	1324
	96	\$335	924	1375

Step 5. Frame Configuration

For 30" high (30) with 54" wide (54) with tackable fabric, horizontal (R)

F0	1 30"-wide frame, 1 24"-wide frame	+\$0
-----------	------------------------------------	------

For 30" high (30) with 60" wide (60) with tackable fabric, horizontal (R)

H0	2 30"-wide frames	+\$0
J0	1 36"-wide frame, 1 24"-wide frame	+\$0

For 30" high (30) with 66" wide (66) with tackable fabric, horizontal (R)

K0	1 36"-wide frame, 1 30"-wide frame	+\$0
L0	1 42"-wide frame, 1 24"-wide frame	+\$0

For 30" high (30) with 72" wide (72) with tackable fabric, horizontal (R)

M0	2 36"-wide frames	+\$0
P0	1 42"-wide frame, 1 30"-wide frame	+\$0
S0	1 48"-wide frame, 1 24"-wide frame	+\$0

For 30" high (30) with 78" wide (78) with tackable fabric, horizontal (R)

U0	1 42"-wide frame, 1 36"-wide frame	+\$0
V0	1 48"-wide frame, 1 30"-wide frame	+\$0

For 30" high (30) with 84" wide (84) with tackable fabric, horizontal (R)

X0	2 42"-wide frames	+\$0
Z0	1 48"-wide frame, 1 36"-wide frame	+\$0

For 30" high (30) with 90" wide (90) with tackable fabric, horizontal (R)

40	1 48"-wide frame, 1 42"-wide frame	+\$0
-----------	------------------------------------	------

For 30" high (30) with 96" wide (96) with tackable fabric, horizontal (R)

50	2 48"-wide frames	+\$0
-----------	-------------------	------

Extended-Width Lower Tile *continued*

Step 6. Surface Finish

For laminate (L)

8Q	folkstone grey	+\$0
91	white	+\$0
LU	soft white	+\$0
WL	sandstone	+\$0

For veneer (W)

2U	light brown walnut <input type="checkbox"/> A	+\$0
40	dark brown walnut	+\$0
ED	aged cherry <input type="checkbox"/> A	+\$0
EK	medium red walnut	+\$0
EW	medium matte walnut	+\$0
ET	clear on ash <input type="checkbox"/> A	+\$0
EU	oak on ash <input type="checkbox"/> A	+\$0
EV	walnut on ash <input type="checkbox"/> A	+\$0
UL	natural maple <input type="checkbox"/> A	+\$0
UX	walnut on cherry <input type="checkbox"/> A	+\$0

Step 7. Horizontal Bead Finish

8Q	folkstone grey	+\$0
91	white	+\$0
98	studio white	+\$0
CL	cool grey neutral	+\$0
G1	graphite	+\$0
LU	soft white	+\$0
MT	medium tone	+\$0
WL	sandstone	+\$0
WN	warm grey neutral	+\$0
CN	metallic champagne	+\$0
EH	metallic bronze	+\$0
MS	metallic silver	+\$0

Step 8. Fabric

For tackable fabric, horizontal (R)

	11	19	30
Price Category 1	+\$0	0	0
Price Category 2	+\$13	25	37
Price Category 3	+\$25	42	66
Price Category 4	+\$44	66	101
Price Category 5	+\$85	136	204
Price Category B	+\$44	69	98
Price Category C	+\$65	97	134
Price Category D	+\$82	123	170
Price Category E	+\$99	148	205
Price Category F	+\$128	191	265
Price Category G	+\$230	230	230

To-The-Floor Lower Tile

FT375.

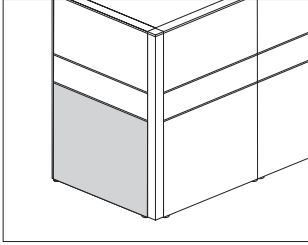

Product Information

Description

This tile attaches to 1 side of a frame to cover the lower zone and conceal the base, eliminating the need for a base cover. It has a tackable fabric, laminate, or veneer surface with a horizontal bead along the top. The tile is UL listed and NFPA classified. Attachment hardware included.

Notes

Tile is designed to be used in the lowest position on frame with no base covers (FT110.xxxxX).

Specify width of tile to match width of frame.

When specifying tackable fabric, horizontal option (R), fabric direction is horizontal (railroaded). Specify all tiles within the workstation the same.

Fabric-covered tile accepts Customer's Own Material (COM). Yardage is estimated for directional, 54"-wide fabrics.

For tackable fabric option (T)

Height—Yardage

24"—.76

35"—1.08

For tackable fabric, horizontal option (R)

Width—Yardage

24"—.88

30"—1.05

36"—1.22

42"—1.4

48"—1.58

For information on multiple quantities or nondirectional fabrics, contact COM Department. See Order Information in Appendices.

Dimensions

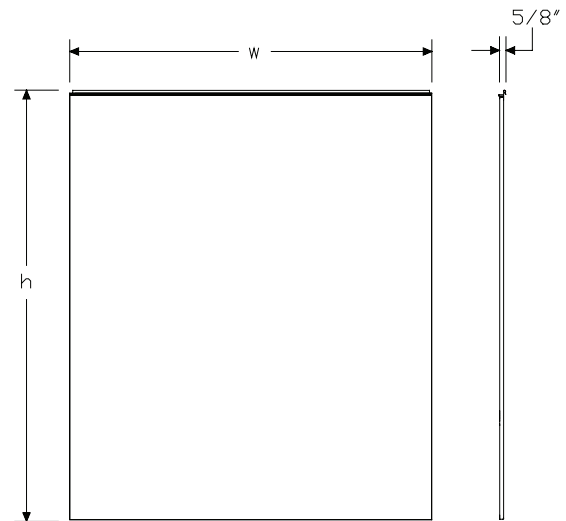

Specification Information

Step 1.
FT375.

Step 2. Height

24	24" high
35	35" high

Step 3. Width

24	24" wide
30	30" wide
36	36" wide
42	42" wide
48	48" wide

Step 4. Surface Material

T	tackable fabric
R	tackable fabric, horizontal
L	laminate
W	veneer <input type="checkbox"/> A

Prices for Steps 1-4.

	T	R	L	W
FT375. 24 24	\$141	157	382	444
30	\$150	168	399	474
36	\$161	181	423	505
42	\$171	191	451	535
48	\$181	202	475	564
35 24	\$174	196	428	553
30	\$173	210	458	600
36	\$199	225	497	650
42	\$212	236	528	698
48	\$223	248	556	764

Step 5. Surface Finish

For laminate (L)

8Q	folkstone grey	+\$0
91	white	+\$0
LU	soft white	+\$0
WL	sandstone	+\$0

For veneer (W)

2U	light brown walnut <input type="checkbox"/> A	+\$0
40	dark brown walnut	+\$0
ED	aged cherry <input type="checkbox"/> A	+\$0
EK	medium red walnut	+\$0
EW	medium matte walnut	+\$0
ET	clear on ash <input type="checkbox"/> A	+\$0
EU	oak on ash <input type="checkbox"/> A	+\$0
EV	walnut on ash <input type="checkbox"/> A	+\$0
UL	natural maple <input type="checkbox"/> A	+\$0
UX	walnut on cherry <input type="checkbox"/> A	+\$0

Step 6. Horizontal Bead Finish

8Q	folkstone grey	+\$0
91	white	+\$0
98	studio white	+\$0
CL	cool grey neutral	+\$0
G1	graphite	+\$0
LU	soft white	+\$0
MT	medium tone	+\$0
WL	sandstone	+\$0
WN	warm grey neutral	+\$0
CN	metallic champagne	+\$0
EH	metallic bronze	+\$0
MS	metallic silver	+\$0

Step 7. Fabric

For tackable fabric (T)

	24	35
Price Category 1	+\$0	0
Price Category 2	+\$13	19
Price Category 3	+\$21	33
Price Category 4	+\$33	51
Price Category 5	+\$69	103
Price Category B	+\$35	52
Price Category C	+\$52	79
Price Category D	+\$69	103
Price Category E	+\$82	128
Price Category F	+\$117	187

To-The-Floor Lower Tile *continued*

Canvas Office Landscape® Walls

<i>For tackable fabric, horizontal (R)</i>		
	24	35
Price Category 1	+\$0	0
Price Category 2	+\$13	19
Price Category 3	+\$21	33
Price Category 4	+\$33	51
Price Category 5	+\$69	103
Price Category B	+\$35	52
Price Category C	+\$52	79
Price Category D	+\$69	103
Price Category E	+\$82	128
Price Category F	+\$117	187
Price Category G	+\$230	230

To-The-Floor Extended-Width Lower Tile

FT376.

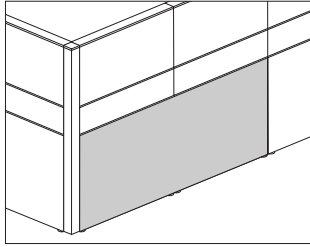

Product Information

Description

This tile attaches to 1 side of 2 adjacent frames to cover the lower zone and conceal the base, eliminating the need for a base cover on that side. It has a tackable fabric, laminate, or veneer surface with a horizontal bead along the top. The tile is UL listed and NFPA classified. Attachment hardware included.

Notes

Tile is designed to be used in the lowest position on frames with no base covers (FT110.xxxxX).

Specify width of tile to match the combined width of 2 frames.

When specifying tackable fabric, horizontal option (R), fabric direction is horizontal (railroaded). Specify all tiles within the workstation the same. Fabric-covered tile accepts Customer's Own Material (COM). Yardage is estimated for directional, 54"-wide fabrics.

Width—Yardage

- 54" —1.75
- 60" —1.93
- 66" —2.11
- 72" —2.29
- 78" —2.47
- 84" —2.65
- 90" —2.83
- 96" —3.01

For information on multiple quantities or nondirectional fabrics, contact COM Department. See Order Information in Appendices.

Dimensions

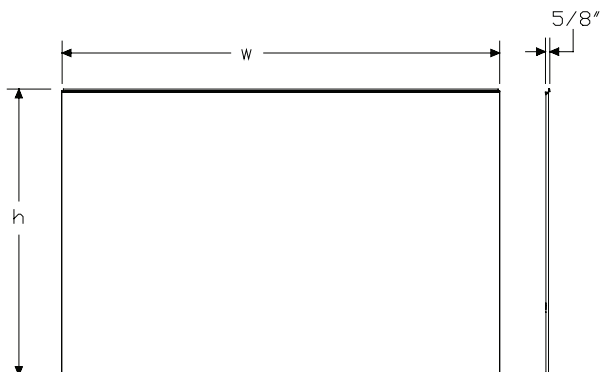

Specification Information

Step 1.

FT376.

Step 2. Height

- 24** 24" high
- 35** 35" high

Step 3. Width

- 54** 54" wide
- 60** 60" wide
- 66** 66" wide
- 72** 72" wide
- 78** 78" wide
- 84** 84" wide
- 90** 90" wide
- 96** 96" wide

Step 4. Surface Material

- R** tackable fabric, horizontal
- L** laminate
- W** veneer

Prices for Steps 1-4.

		R	L	W
FT376. 24	54	\$270	656	773
	60	\$280	672	798
	66	\$292	696	824
	72	\$302	715	850
	78	\$312	745	875
	84	\$320	779	900
	90	\$326	814	927
	96	\$340	843	1053
35	54	\$339	745	972
	60	\$350	779	1024
	66	\$360	824	1078
	72	\$374	864	1141
	78	\$385	887	1218
	84	\$391	924	1305
	90	\$391	957	1355
	96	\$419	986	1432

Step 5. Frame Configuration

For 35" high (35) with 54" wide (54) with tackable fabric, horizontal (R)
F0 1 30"-wide frame, 1 24"-wide frame +\$0

To-The-Floor Extended-Width Lower Tile *continued*

For 35" high (35) with 60" wide (60) with tackable fabric, horizontal (R)

H0	2 30"-wide frames	+\$0
J0	1 36"-wide frame, 1 24"-wide frame	+\$0

For 35" high (35) with 66" wide (66) with tackable fabric, horizontal (R)

K0	1 36"-wide frame, 1 30"-wide frame	+\$0
L0	1 42"-wide frame, 1 24"-wide frame	+\$0

For 35" high (35) with 72" wide (72) with tackable fabric, horizontal (R)

M0	2 36"-wide frames	+\$0
P0	1 42"-wide frame, 1 30"-wide frame	+\$0
S0	1 48"-wide frame, 1 24"-wide frame	+\$0

For 35" high (35) with 78" wide (78) with tackable fabric, horizontal (R)

U0	1 42"-wide frame, 1 36"-wide frame	+\$0
V0	1 48"-wide frame, 1 30"-wide frame	+\$0

For 35" high (35) with 84" wide (84) with tackable fabric, horizontal (R)

X0	2 42"-wide frames	+\$0
Z0	1 48"-wide frame, 1 36"-wide frame	+\$0

For 35" high (35) with 90" wide (90) with tackable fabric, horizontal (R)

40	1 48"-wide frame, 1 42"-wide frame	+\$0
-----------	------------------------------------	------

For 35" high (35) with 96" wide (96) with tackable fabric, horizontal (R)

50	2 48"-wide frames	+\$0
-----------	-------------------	------

Step 6. Surface Finish

For laminate (L)

8Q	folkstone grey	+\$0
91	white	+\$0
LU	soft white	+\$0
WL	sandstone	+\$0

For veneer (W)

2U	light brown walnut <input type="checkbox"/> A	+\$0
40	dark brown walnut	+\$0
ED	aged cherry <input type="checkbox"/> A	+\$0
EK	medium red walnut	+\$0
EW	medium matte walnut	+\$0
ET	clear on ash <input type="checkbox"/> A	+\$0
EU	oak on ash <input type="checkbox"/> A	+\$0
EV	walnut on ash <input type="checkbox"/> A	+\$0
UL	natural maple <input type="checkbox"/> A	+\$0
UX	walnut on cherry <input type="checkbox"/> A	+\$0

Step 7. Horizontal Bead Finish

8Q	folkstone grey	+\$0
91	white	+\$0
98	studio white	+\$0
CL	cool grey neutral	+\$0
G1	graphite	+\$0
LU	soft white	+\$0
MT	medium tone	+\$0
WL	sandstone	+\$0
WN	warm grey neutral	+\$0
CN	metallic champagne	+\$0
EH	metallic bronze	+\$0
MS	metallic silver	+\$0

Step 8. Fabric

For tackable fabric, horizontal (R)

	24	35
Price Category 1	+\$0	0
Price Category 2	+\$25	37
Price Category 3	+\$42	66
Price Category 4	+\$66	101
Price Category 5	+\$137	204
Price Category B	+\$69	103
Price Category C	+\$103	150
Price Category D	+\$137	190
Price Category E	+\$167	230
Price Category F	+\$215	297
Price Category G	+\$230	230

Lower Power/Data Tile

FT171.
FT172.
FT17R.

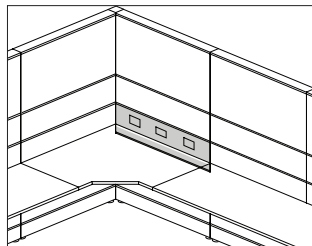

Product Information

Description

This tile attaches to 1 side of a frame to provide access to power and data near the frame's base, just below the surface, or just above the surface. It has a painted or fabric surface and a horizontal bead along the top. The tile is UL listed and NFPA classified. Attachment hardware is included.

To cover the lower zone of a frame, specify 1 of the following:

- 30"-high lower power/data tile
- 19"-high lower tile (FT170.19) and 11"-high lower power/data tile
- 19"-high lower power/data tile and 11"-high lower tile (FT170.11)
- 19"-high lower power/data tile and 11"-high lower power/data tile

Cutout options have the following power and data cutouts:

- A: 2 power cutouts and 1 data cutout above the surface
- B: 2 power cutouts and 1 data cutout above the surface (Chicago)
- C: 2 power cutouts and 1 data cutout below the surface
- D: 2 power cutouts at bottom of tile
- E: 2 power cutouts and 1 data cutout below the surface (Chicago)

24"-wide tiles with cutouts for standard power (options A, C, and D) have 1 power cutout or 1 power cutout and 1 data cutout.

Notes

Specify width of tile to match width of frame.

To access power, order lower power/data tile power harness (FT152.) separately.

Tile with Power/data cutouts above work surface option (A) includes a communication faceplate extender and covers for the power/data openings.

For tile with cutouts for hardwired junction boxes (Chicago), specify hardwire mounting rail (FT157.) separately.

35"-high frame cannot accept power/data tile in the top location.

When specifying fabric, horizontal tile (FT17R.), fabric direction is horizontal (railroaded). Specify all tiles within the workstation the same.

Fabric-covered tile accepts Customer's Own Material (COM). Yardage is estimated for directional, 54"-wide fabrics.

For fabric tile (FT171.)

Height—Yardage

11"—0.50

19"—0.74

30"—1.06

For fabric, horizontal tile (FT17R.)

Width—Yardage

24"—.88

30"—1.05

36"—1.22

42"—1.4

48"—1.58

For information on multiple quantities or nondirectional fabrics, contact COM Department. See Order Information in Appendices.

Dimensions

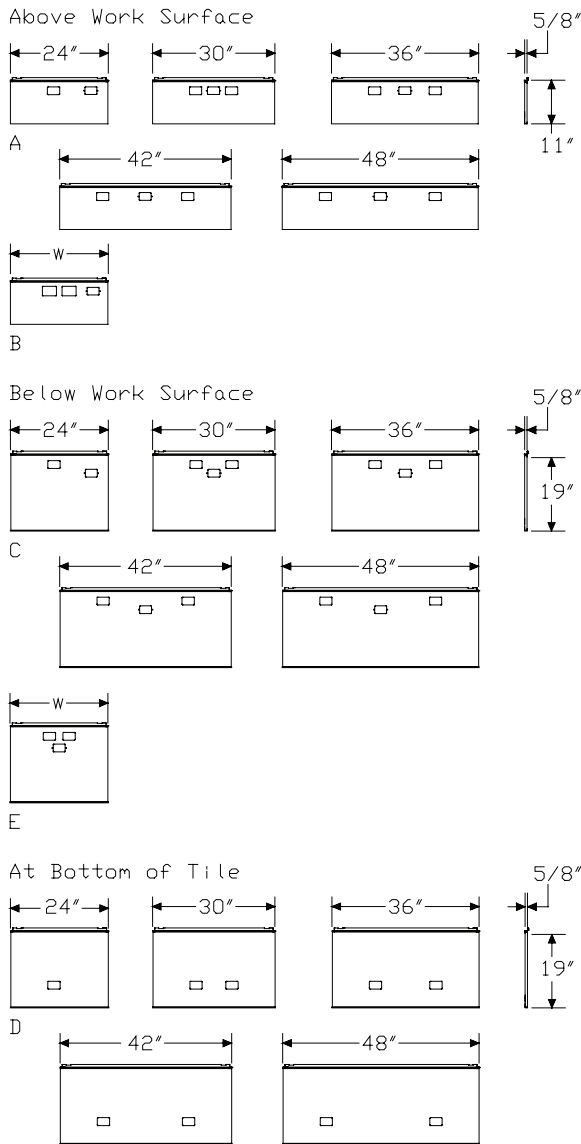

Specification Information

Step 1.
FT17

Step 2. Surface Material

- 1. painted
- 2. fabric
- R. fabric, horizontal

Step 3. Height

- 11 11" high
- 19 19" high
- 30 30" high

Step 4. Width

- 24 24" wide
- 30 30" wide
- 36 36" wide
- 42 42" wide
- 48 48" wide

Step 5. Cutout Location

For painted (1.) with 11" high (11)

- A power/data cutouts above work surface
- B power/data cutouts above work surface (meets Chicago electrical code requirements)

For painted (1.) with 19" high (19)

- C power/data cutouts below work surface
- D power cutouts at bottom of tile
- E power/data cutouts below work surface (meets Chicago electrical code requirements)

For fabric (2.) with 11" high (11)

- A power/data cutouts above work surface
- B power/data cutouts above work surface (meets Chicago electrical code requirements)

For fabric (2.) with 19" high (19)

- C power/data cutouts below work surface
- D power cutouts at bottom of tile
- E power/data cutouts below work surface (meets Chicago electrical code requirements)

Lower Power/Data Tile *continued*

For painted (1.) with 30" high (30)

A	power/data cutouts above work surface
B	power/data cutouts above work surface (meets Chicago electrical code requirements)
C	power/data cutouts below work surface
D	power cutouts at bottom of tile
E	power/data cutouts below work surface (meets Chicago electrical code requirements)

For fabric (2.) with 30" high (30)

A	power/data cutouts above work surface
C	power/data cutouts below work surface
D	power cutouts at bottom of tile

For fabric, horizontal (R.) with 11" high (11)

A	power/data cutouts above work surface
B	power/data cutouts above work surface (meets Chicago electrical code requirements)

For fabric, horizontal (R.) with 19" high (19)

C	power/data cutouts below work surface
D	power cutouts at bottom of tile
E	power/data cutouts below work surface (meets Chicago electrical code requirements)

For fabric, horizontal (R.) with 30" high (30)

A	power/data cutouts above work surface
C	power/data cutouts below work surface
D	power cutouts at bottom of tile

Prices for Steps 1-5.

	A	B	C	D	E
FT171. 11 24	\$89	89	—	—	—
30	\$92	92	—	—	—
36	\$95	95	—	—	—
42	\$98	98	—	—	—
48	\$101	101	—	—	—
19 24	—	—	\$105	105	105
30	—	—	\$111	111	111
36	—	—	\$116	116	116
42	—	—	\$121	121	121
48	—	—	\$126	126	126
30 24	\$130	130	130	130	130
30	\$136	136	136	136	136
36	\$143	143	143	143	143
42	\$150	150	150	150	150
48	\$156	156	156	156	156

	A	B	C	D	E
FT172. 11 24	\$112	118	—	—	—
30	\$116	122	—	—	—
36	\$119	125	—	—	—
42	\$122	128	—	—	—
48	\$125	132	—	—	—
19 24	—	—	\$133	133	140
30	—	—	\$138	138	145
36	—	—	\$143	143	150
42	—	—	\$148	148	156
48	—	—	\$155	155	163
30 24	\$156	—	156	156	—
30	\$164	—	164	164	—
36	\$179	—	179	179	—
42	\$187	—	187	187	—
48	\$196	—	196	196	—

	A	B	C	D	E
FT17R. 11 24	\$124	134	—	—	—
30	\$127	139	—	—	—
36	\$130	142	—	—	—
42	\$134	145	—	—	—
48	\$137	148	—	—	—
19 24	—	—	\$147	140	147
30	—	—	\$152	145	152
36	—	—	\$158	150	158
42	—	—	\$165	157	165
48	—	—	\$170	162	170
30 24	\$163	—	171	163	—
30	\$171	—	181	171	—
36	\$188	—	197	188	—
42	\$196	—	206	196	—
48	\$205	—	217	205	—

Step 6. Surface Finish
For painted (1.)

Sand Texture Paint	
98	studio white +\$0
8Q	folkstone grey +\$0
WL	sandstone +\$0

Bright Sand Texture Paint	
91	white +\$0
CL	cool grey neutral +\$0
G1	graphite +\$0
WN	warm grey neutral +\$0

Metallic Paint		
CN	metallic champagne	+\$0
EH	metallic bronze	+\$0
MS	metallic silver	+\$0

Step 7. Horizontal Bead Finish		
8Q	folkstone grey	+\$0
91	white	+\$0
98	studio white	+\$0
CL	cool grey neutral	+\$0
G1	graphite	+\$0
LU	soft white	+\$0
MT	medium tone	+\$0
WL	sandstone	+\$0
WN	warm grey neutral	+\$0
CN	metallic champagne	+\$0
EH	metallic bronze	+\$0
MS	metallic silver	+\$0

Step 8. Receptacle Trim Finish		
8Q	folkstone grey	+\$0
98	studio white	+\$0
WL	sandstone	+\$0
91	white	+\$0
CL	cool grey neutral	+\$0
G1	graphite	+\$0
WN	warm grey neutral	+\$0

Step 9. Surface Finish
 See application chart and textiles list for fabric usage and numbers.
 First 2 digits of number indicate fabric line; remaining digit(s) indicate fabric color.

For fabric (2.) AND fabric, horizontal (R.)			
	11	19	30
Price Category 1	+\$0	0	0
Price Category 2	+\$7	13	19
Price Category 3	+\$13	21	33
Price Category 4	+\$18	33	51
Price Category 5	+\$43	69	103
Price Category B	+\$22	35	52
Price Category C	+\$33	52	79
Price Category D	+\$43	69	103
Price Category E	+\$54	84	128
Price Category F	+\$80	122	174
Price Category G	+\$107	158	226

Extended-Width Lower Power/ Data Tile

FT36R.

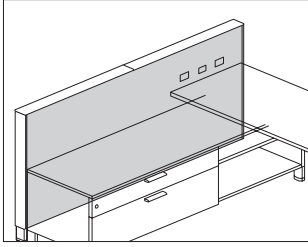

Product Information

Description

This tile attaches to 1 side of 2 adjacent frames to provide access to power and data just below the surface or just above the surface. It has a fabric surface and a horizontal bead along the top. The tile is UL listed and NFPA classified. Attachment hardware is included.

Notes

Specify width of tile to match the combined width of 2 frames.

Fabric direction is horizontal (railroaded). Specify all tiles within the work station the same.

Tile accepts Customer's Own Material (COM). Yardage is estimated for directional, 54"-wide fabrics.

Width—Yardage

60" —1.93

72" —2.29

84" —2.65

96" —3.01

For information on multiple quantities or nondirectional fabrics, contact COM Department. See Order Information in Appendices.

Dimensions

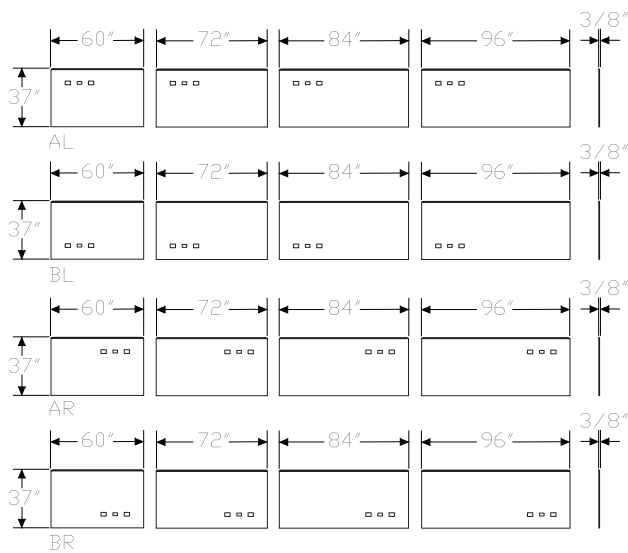

Specification Information

Step 1.

FT36

Step 2. Surface Material

R. fabric, horizontal

Step 3. Height

37 37" high

41 41" high

Step 4. Width

60 60" wide

72 72" wide

84 84" wide

96 96" wide

Step 5. Cutout Location

AL power/data cutouts above work surface-left

AR power/data cutouts above work surface-right

BL power/data cutouts below work surface-left

BR power/data cutouts below work surface-right

Prices for Steps 1-5.

	AL	AR	BL	BR
FT36R. 37 60	\$324	324	324	324
72	\$344	344	344	344
84	\$363	363	363	363
96	\$384	384	384	384
41 60	\$340	340	340	340
72	\$359	359	359	359
84	\$379	379	379	379
96	\$394	394	394	394

Step 6. Frame Configuration

For 60" wide (60)

H0 2 30"-wide frames +\$0

For 72" wide (72)

M0 2 36"-wide frames +\$0

For 84" wide (84)

X0 2 42"-wide frames +\$0

For 96" wide (96)

50 2 48"-wide frames +\$0

Extended-Width Lower Power/ Data Tile *continued*

Step 7. Horizontal Bead Finish		
8Q	folkstone grey	+\$0
91	white	+\$0
98	studio white	+\$0
CL	cool grey neutral	+\$0
G1	graphite	+\$0
LU	soft white	+\$0
MT	medium tone	+\$0
WL	sandstone	+\$0
WN	warm grey neutral	+\$0
CN	metallic champagne	+\$0
EH	metallic bronze	+\$0
MS	metallic silver	+\$0

Step 8. Receptacle Trim Finish		
8Q	folkstone grey	+\$0
91	white	+\$0
98	studio white	+\$0
CL	cool grey neutral	+\$0
G1	graphite	+\$0
WL	sandstone	+\$0
WN	warm grey neutral	+\$0

Step 9. Surface Finish		
Price Category 1		+\$0
Price Category 2		+\$44
Price Category 3		+\$76
Price Category 4		+\$119
Price Category 5		+\$248
Price Category B		+\$125
Price Category C		+\$187
Price Category D		+\$246
Price Category E		+\$308
Price Category F		+\$451
Price Category G		+\$230

Lower Power/Data Tile, Low Credenza Height

FT371.
FT372.
FT37R.

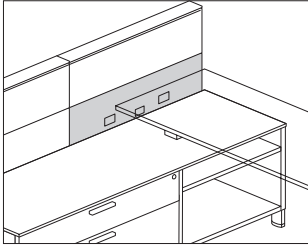

Product Information

Description

This 30"-high tile attaches to 1 side of a frame to provide access to power and data above a low credenza. It has a painted or fabric surface and a horizontal bead along the top. The tile is UL listed and NFPA classified. Attachment hardware included.

Notes

- Specify width of tile to match width of frame.
- To access modular power, order power harness, low credenza height (FT15A.) separately.
- Placement of a 3 duplex receptacle tile on both sides of a frame requires a 3 duplex low credenza height tile (FT371., FT372., FT37R.) with left orientation (F) option on 1 side of the frame, a right orientation (G) option on the other side of the frame, and a 3 receptacle low credenza height power/data harness (FT15A.3.) ordered separately.
- To access hardwired junction boxes (Chicago), order hardwire mounting kit, low credenza (FT15C.) separately.
- When specifying fabric, horizontal tile (FT37R.), fabric direction is horizontal (railroaded). Specify all tiles within the workstation the same. Fabric-covered tile accepts Customer's Own Material (COM). Yardage is estimated for directional, 54"-wide fabrics.
- For fabric tile (FT371.)
- Height—Yardage
 - 11"—0.50
 - 19"—0.74
 - 30"—1.06
- For fabric, horizontal tile (FT37R.)
- Width—Yardage
 - 24"—.88
 - 30"—1.05
 - 36"—1.22
 - 42"—1.4
 - 48"—1.58
- For information on multiple quantities or nondirectional fabrics, contact COM Department. See Order Information in Appendices.

Dimensions

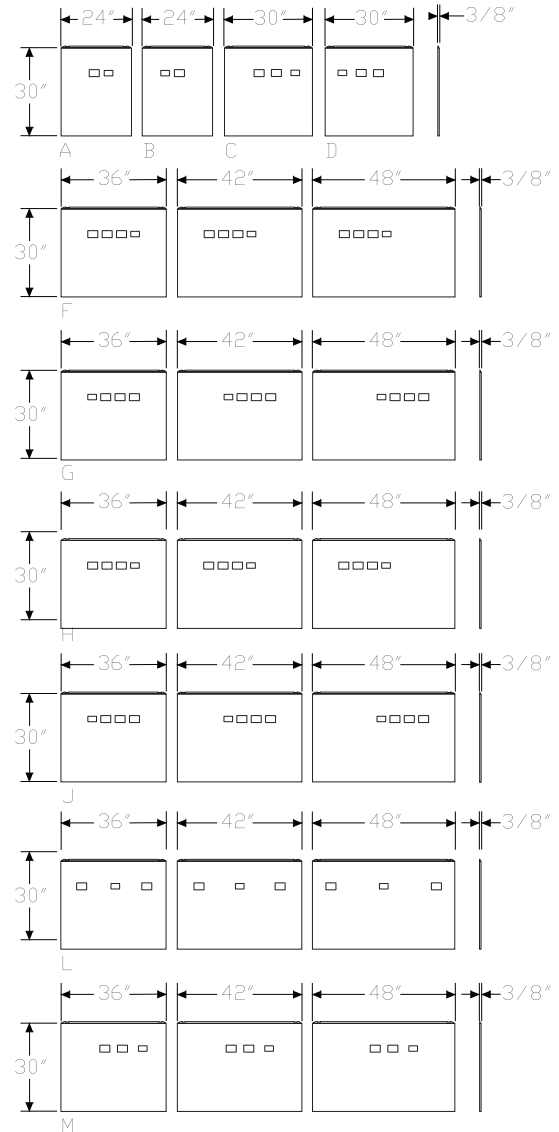

Lower Power/Data Tile, Low
Credenza Height *continued*

Specification Information

Step 1.

FT37 A

Step 2. Surface Material

- 1. painted A
- 2. fabric A
- R. fabric, horizontal A

Step 3. Height

30 30" high A

Step 4. Width

- 24** 24" wide A
- 30** 30" wide A
- 36** 36" wide A
- 42** 42" wide A
- 48** 48" wide A

Step 5. Cutout Location

For 24" wide (24)

- A** 1 duplex receptacle, 1 data opening left A
- B** 1 duplex receptacle, 1 data opening right A

For 30" wide (30)

- C** 2 duplex receptacles, 1 data opening left A
- D** 2 duplex receptacles, 1 data opening right A

For 36" wide (36), 42" wide (42), or 48" wide (48)

- F** 3 duplex receptacles, 1 data opening left A
- G** 3 duplex receptacles, 1 data opening right A
- H** 3 duplex receptacles, 1 data opening left (meets Chicago electrical code requirements) A
- J** 3 duplex receptacles, 1 data opening right (meets Chicago electrical code requirements) A
- L** 2 duplex receptacles, 1 data opening centered A
- M** 2 duplex receptacles, 1 data opening centered (meets Chicago electrical code requirements) A

Prices for Steps 1-5.

	A	C	F	B	D	G
FT371. 30 24	\$140	—	—	140	—	—
30	—	\$147	—	—	147	—
36	—	—	\$153	—	—	153
42	—	—	\$160	—	—	160
48	—	—	\$166	—	—	166

	H	J	L	M
FT371. 30 36	\$153	153	143	143
42	\$160	160	150	150
48	\$166	166	156	156

	A	C	F	B	D	G
FT372. 30 24	\$183	—	—	183	—	—
30	—	\$191	—	—	191	—
36	—	—	\$200	—	—	200
42	—	—	\$210	—	—	210
48	—	—	\$219	—	—	219

	H	J	L	M
FT372. 30 36	\$200	200	188	188
42	\$210	210	197	197
48	\$219	219	208	208

	A	C	F	B	D	G
FT37R. 30 24	\$189	—	—	189	—	—
30	—	\$198	—	—	198	—
36	—	—	\$208	—	—	208
42	—	—	\$215	—	—	215
48	—	—	\$224	—	—	224

	H	J	L	M
FT37R. 30 36	\$208	208	193	193
42	\$215	215	202	202
48	\$224	224	213	213

Step 6. Surface Finish
For painted (1.)

Sand Texture Paint		
98	studio white	+\$0
8Q	folkstone grey	+\$0
WL	sandstone	+\$0

Bright Sand Texture Paint		
91	white <input type="checkbox"/> A	+\$0
CL	cool grey neutral <input type="checkbox"/> A	+\$0
G1	graphite <input type="checkbox"/> A	+\$0
WN	warm grey neutral <input type="checkbox"/> A	+\$0

Metallic Paint		
CN	metallic champagne <input type="checkbox"/> A	+\$0
EH	metallic bronze <input type="checkbox"/> A	+\$0
MS	metallic silver <input type="checkbox"/> A	+\$0

Lower Power/Data Tile, Low Credenza Height *continued*

Step 7. Horizontal Bead Finish

8Q	folkstone grey	+\$0
91	white <input type="checkbox"/>	+\$0
98	studio white	+\$0
CL	cool grey neutral <input type="checkbox"/>	+\$0
G1	graphite <input type="checkbox"/>	+\$0
LU	soft white	+\$0
MT	medium tone	+\$0
WL	sandstone	+\$0
WN	warm grey neutral <input type="checkbox"/>	+\$0
CN	metallic champagne <input type="checkbox"/>	+\$0
EH	metallic bronze <input type="checkbox"/>	+\$0
MS	metallic silver <input type="checkbox"/>	+\$0

Step 8. Receptacle Trim Finish

8Q	folkstone grey <input type="checkbox"/>	+\$0
98	studio white <input type="checkbox"/>	+\$0
WL	sandstone <input type="checkbox"/>	+\$0
91	white <input type="checkbox"/>	+\$0
CL	cool grey neutral <input type="checkbox"/>	+\$0
G1	graphite <input type="checkbox"/>	+\$0
WN	warm grey neutral <input type="checkbox"/>	+\$0

Step 9. Surface Finish

For fabric (2.) or fabric, horizontal (R.)

Price Category 1	+\$0
Price Category 2	+\$17
Price Category 3	+\$30
Price Category 4	+\$46
Price Category 5	+\$93
Price Category B	+\$47
Price Category C	+\$71
Price Category D	+\$93
Price Category E	+\$116
Price Category F	+\$161
Price Category G	+\$363

Extended-Width Lower Power/ Data Tile, Low Credenza Height

FT39R.

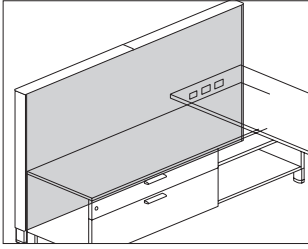

Canvas Office Landscape® Walls

Product Information

Description

This tile attaches to 1 side of 2 adjacent frames to provide access to power and data above a low credenza. It has a fabric surface and a horizontal bead along the top. The tile is UL listed and NFPA classified. Attachment hardware included.

Notes

Specify width of tile to match the combined width of 2 frames.
 Placement of an extended width 3 duplex receptacle tile on both sides of a frame requires an extended width 3 duplex low credenza height tile (FT39R.) with left orientation (F) option on 1 side of the frame, a right orientation (G) option on the other side of the frame, and a 3 receptacle low credenza height power/data harness (FT15A.3), ordered separately. Fabric direction is horizontal (railroaded). Specify all tiles within the work station the same.

Tile accepts Customer's Own Material (COM). Yardage is estimated for directional 54"-wide fabrics.

Width—Yardage

- 60" — 1.93
- 72" — 2.29
- 84" — 2.65
- 96" — 3.01

For information on multiple quantities or nondirectional fabrics, contact COM Department. See Order Information in Appendices.

Dimensions

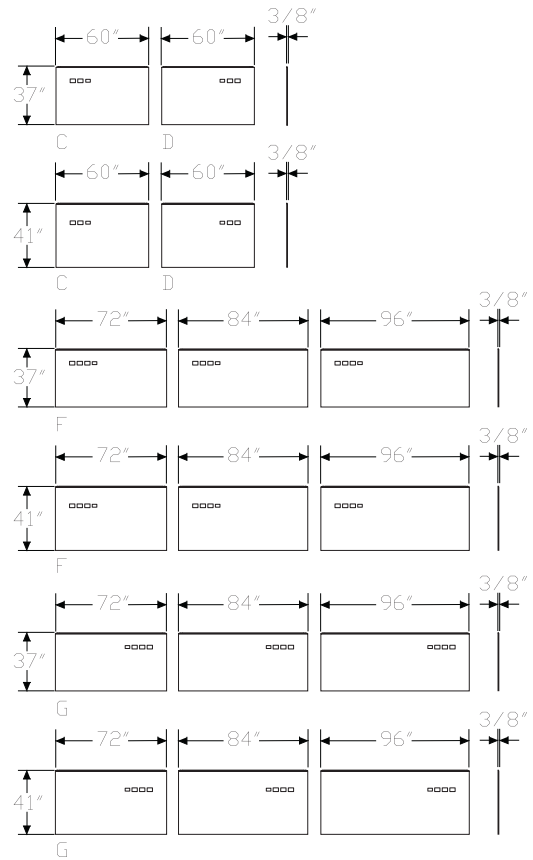

Extended-Width Lower Power/ Data Tile, Low Credenza Height

continued

Specification Information

Step 1.
FT39

Step 2. Surface Material
R. fabric, horizontal

Step 3. Height
37 37" high
41 41" high

Step 4. Width
60 60" wide
72 72" wide
84 84" wide
96 96" wide

Step 5. Cutout Location

For 60" wide (60)
C 2 duplex receptacles, 1 data opening left
D 2 duplex receptacles, 1 data opening right

For 72" wide (72), 84" wide (84), or 96" wide (96)
F 3 duplex receptacles, 1 data opening left
G 3 duplex receptacles, 1 data opening right

Prices for Steps 1-5.

	C	F	D	G
FT39R. 37 60	\$365	—	365	—
72	—	\$386	—	386
84	—	\$409	—	409
96	—	\$430	—	430
41 60	\$381	—	381	—
72	—	\$403	—	403
84	—	\$424	—	424
96	—	\$441	—	441

Step 6. Frame Configuration

For 60" wide (60)
H0 2 30"-wide frames +\$0

For 72" wide (72)
M0 2 36"-wide frames +\$0

For 84" wide (84)
X0 2 42"-wide frames +\$0

For 96" wide (96)
50 2 48"-wide frames +\$0

Step 7. Horizontal Bead Finish

8Q folkstone grey +\$0
91 white +\$0
98 studio white +\$0
CL cool grey neutral +\$0
G1 graphite +\$0
LU soft white +\$0
MT medium tone +\$0
WL sandstone +\$0
WN warm grey neutral +\$0
CN metallic champagne +\$0
EH metallic bronze +\$0
MS metallic silver +\$0

Step 8. Receptacle Trim Finish

8Q folkstone grey +\$0
91 white +\$0
98 studio white +\$0
CL cool grey neutral +\$0
G1 graphite +\$0
WL sandstone +\$0
WN warm grey neutral +\$0

Step 9. Surface Finish

Price Category 1 +\$0
Price Category 2 +\$17
Price Category 3 +\$30
Price Category 4 +\$46
Price Category 5 +\$93
Price Category B +\$47
Price Category C +\$71
Price Category D +\$93
Price Category E +\$116
Price Category F +\$161
Price Category G +\$363

Lower Open Tile

FT174.

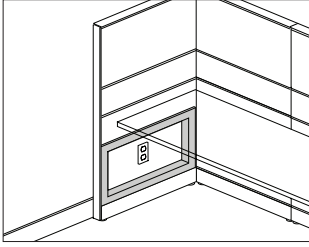

Canvas Office Landscape® Walls

Product Information

Description

This 19"-high open tile attaches to 1 side of an equal-width frame. It is used in the bottom portion of a base frame. The open tile cannot be used with wall strips, tile adapters, or a power jumper. Each tile has a horizontal bead along the top of the tile and includes attachment hardware.

Notes

Specify width of tile to match width of frame.

Specify 1 open tile per frame; back side remains open.

Dimensions

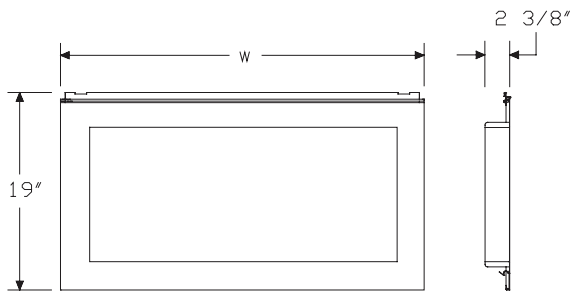

Specification Information

Step 1.

FT174.

Step 2. Width

24	24" wide
30	30" wide
36	36" wide
42	42" wide
48	48" wide

Prices for Steps 1-2.

FT174. 24	\$171
30	\$184
36	\$208
42	\$220
48	\$237

Step 3. Surface Finish

Sand Texture Paint

98	studio white <input type="checkbox"/> A	+ \$0
8Q	folkstone grey <input type="checkbox"/> A	+ \$0
WL	sandstone <input type="checkbox"/> A	+ \$0

Bright Sand Texture Paint

91	white	+ \$0
CL	cool grey neutral	+ \$0
G1	graphite	+ \$0
WN	warm grey neutral	+ \$0

Metallic Paint

CN	metallic champagne	+ \$0
EH	metallic bronze	+ \$0
MS	metallic silver	+ \$0

Lower Open Tile *continued*

Step 4. Horizontal Bead Finish

8Q	folkstone grey	+\$0
91	white	+\$0
98	studio white	+\$0
CL	cool grey neutral	+\$0
G1	graphite	+\$0
LU	soft white	+\$0
MT	medium tone	+\$0
WL	sandstone	+\$0
WN	warm grey neutral	+\$0
CN	metallic champagne	+\$0
EH	metallic bronze	+\$0
MS	metallic silver	+\$0

Upper Tile

FT181.

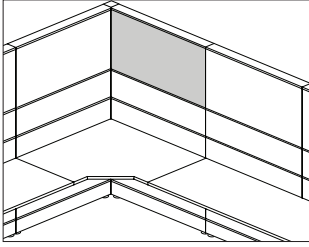

Canvas Office Landscape® Walls

Product Information

Description

This tile attaches to 1 side of a frame and has a painted, tackable fabric, marker board, veneer, or debossed metal surface. It provides a finished cover above a surface. Each tile has a horizontal bead along the top of the tile. The tile is UL listed and NFPA classified. Attachment hardware is included.

Notes

Specify width of tile to match width of frame.

7"-high tile attaches to the top position of a 42"- or 53"-high frame only.

18"-high tile attaches to the top position of a 53"-high frame only.

When specifying tackable fabric, horizontal option (R), fabric direction is horizontal (railroaded). Specify all tiles within the workstation the same. Fabric-covered tile accepts Customer's Own Material (COM). Yardage is estimated for directional, 54"-wide fabrics.

For tackable fabric option (T)

Height—Yardage

7"—0.38

11"—0.50

22"—0.83

33"—1.15

For tackable fabric, horizontal option (R)

Width—Yardage

24"—.88

30"—1.05

36"—1.22

42"—1.4

48"—1.58

For information on multiple quantities or nondirectional fabrics, contact COM Department. See Order Information in Appendices.

Dimensions

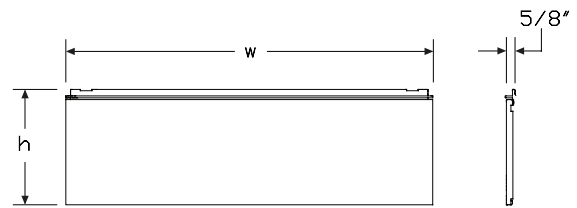

Painted, Fabric, Marker Board,
Laminate, Veneer

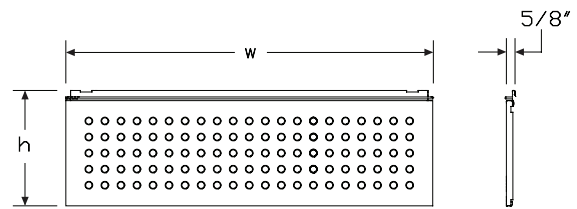

Debossed

Specification Information

Step 1.

FT181.

Step 2. Height

07	7" high (for 42" and 53" high frames only)
11	11" high
18	18" high (for 53" high frames only)
22	22" high
33	33" high

Step 3. Width

18	18" wide
24	24" wide
30	30" wide
36	36" wide
42	42" wide
48	48" wide

Step 4. Surface Material

For 7" high (for 42" and 53" high frames only) (07)

P	paint
T	tackable fabric
W	veneer A
L	laminate
R	tackable fabric, horizontal

For 11" high (11), 18" high (for 53" high frames only) (18), 22" high (22), or 33" high (33)

P	paint
T	tackable fabric
M	marker board
W	veneer A
X	debossed
L	laminate
R	tackable fabric, horizontal

Prices for Steps 1-4.

	P	T	M	W	X	L
FT181. 07 18	\$43	62	—	244	—	194
24	\$45	64	—	252	—	199
30	\$47	70	—	268	—	212
36	\$50	74	—	284	—	223
42	\$53	78	—	300	—	234
48	\$57	83	—	318	—	247

11 18	\$51	71	123	273	87	226
24	\$53	74	127	280	89	231
30	\$56	80	139	296	96	244
36	\$59	86	153	315	105	259
42	\$62	93	167	331	113	272
48	\$65	97	184	349	120	286
18 18	\$71	96	158	386	119	301
24	\$73	100	167	398	121	314
30	\$78	111	184	434	130	335
36	\$83	118	201	467	139	354
42	\$88	128	223	501	149	373
48	\$93	137	244	536	158	392
22 18	\$71	96	158	386	119	301
24	\$73	100	167	398	121	314
30	\$78	111	184	400	130	335
36	\$83	118	201	467	139	354
42	\$88	128	223	501	149	373
48	\$93	137	244	536	158	392
33 18	\$92	128	199	486	149	373
24	\$97	136	215	524	154	413
30	\$106	146	235	575	166	456
36	\$114	157	258	627	179	499
42	\$121	168	284	677	191	544
48	\$128	179	313	729	204	587

	R
FT181. 07 18	\$64
24	\$65
30	\$71
36	\$77
42	\$81
48	\$85
11 18	\$74
24	\$77
30	\$83
36	\$90
42	\$95
48	\$100
18 18	\$99
24	\$103
30	\$113
36	\$123
42	\$134
48	\$140

22 18	\$99
24	\$103
30	\$113
36	\$123
42	\$134
48	\$140
33 18	\$134
24	\$139
30	\$149
36	\$161
42	\$175
48	\$185

Step 5. Surface Finish

Sand Texture Paint

For painted (P) or debossed (X)

98 studio white A	+\$0
8Q folkstone grey A	+\$0
WL sandstone A	+\$0

Bright Sand Texture Paint

For painted (P) or debossed (X)

91 white	+\$0
CL cool grey neutral	+\$0
G1 graphite	+\$0
WN warm grey neutral	+\$0

Metallic Paint

For painted (P) or debossed (X)

CN metallic champagne	+\$0
EH metallic bronze	+\$0
MS metallic silver	+\$0

For laminate (L)

8Q folkstone grey	+\$0
91 white	+\$0
LU soft white	+\$0
WL sandstone	+\$0

Wood Veneer

For veneer (W)

2U light brown walnut A	+\$0
40 dark brown walnut	+\$0
ED aged cherry A	+\$0
EK medium red walnut	+\$0
EW medium matte walnut	+\$0
ET clear on ash A	+\$0
EU oak on ash A	+\$0
EV walnut on ash A	+\$0
UL natural maple A	+\$0
UX walnut on cherry A	+\$0

Step 6. Horizontal Bead Finish

8Q folkstone grey	+\$0
91 white	+\$0
98 studio white	+\$0
CL cool grey neutral	+\$0
G1 graphite	+\$0
MT medium tone	+\$0
WL sandstone	+\$0
WN warm grey neutral	+\$0
CN metallic champagne	+\$0
EH metallic bronze	+\$0
MS metallic silver	+\$0

Step 7. Surface Finish

For tackable fabric (T) AND tackable fabric, horizontal (R)

	07	11	18	22	33
Price Category 1	+\$0	0	0	0	0
Price Category 2	+\$4	7	13	13	19
Price Category 3	+\$8	13	21	21	33
Price Category 4	+\$11	18	33	33	51
Price Category 5	+\$77	43	77	77	112
Price Category B	+\$14	22	39	39	57
Price Category C	+\$21	33	59	59	84
Price Category D	+\$27	43	77	77	112
Price Category E	+\$33	54	95	95	139
Price Category F	+\$54	80	140	140	203
Price Category G	+\$0	107	0	0	0

Extended-Width Upper Tile

FT381.

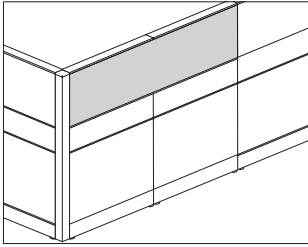

Product Information

Description

This tile attaches to 1 side of 2 adjacent frames and has a tackable fabric, laminate, or veneer surface with a horizontal bead along the top. The tile is UL listed and NFPA classified. Attachment hardware included.

Notes

Specify width of tile to match the combined width of 2 frames.
 7"-high tile attaches to the top position of a 42"- or 53"-high frame only.
 18"-high tile attaches to the top position of a 53"-high frame only.
 When specifying tackable fabric, horizontal option (R), fabric direction is horizontal (railroaded). Specify all tiles within the workstation the same.
 Fabric-covered tile accepts Customer's Own Material (COM). Yardage is estimated for directional, 54"-wide fabrics.

Width—Yardage

- 54" — 1.75
- 60" — 1.93
- 66" — 2.11
- 72" — 2.29
- 78" — 2.47
- 84" — 2.65
- 90" — 2.83
- 96" — 3.01

Yardage for 54"-wide fabric covers up to 4 7"-high tiles, 3 11"-high tiles, 2 22"-high tiles, or 1 33"-high tile.

For information on additional quantities or nondirectional fabrics, contact COM Department. See Order Information in Appendices.

Dimensions

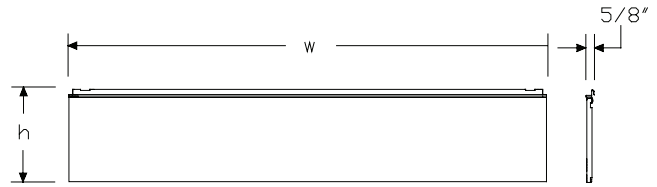

Specification Information	
Step 1.	
FT381.	
Step 2. Height	
07	7" high (for 42" and 53" high frames only)
11	11" high
18	18" high (for 53" high frames only)
22	22" high
33	33" high
Step 3. Width	
54	54" wide
60	60" wide
66	66" wide
72	72" wide
78	78" wide
84	84" wide
90	90" wide
96	96" wide
Step 4. Surface Material	
R	tackable fabric, horizontal
L	laminate
W	veneer <input type="checkbox"/> A

Prices for Steps 1-4.

	R	L	W
FT381. 07 54	\$136	378	470
60	\$142	396	501
66	\$147	406	528
72	\$151	421	558
78	\$163	474	616
84	\$169	532	652
90	\$171	560	684
96	\$177	582	699
11 54	\$159	427	517
60	\$163	437	533
66	\$170	473	577
72	\$178	488	592
78	\$191	550	672
84	\$199	567	688
90	\$205	581	704
96	\$210	596	726

18 54	\$212	560	721
60	\$230	585	757
66	\$244	618	824
72	\$267	667	860
78	\$287	695	980
84	\$298	744	1017
90	\$317	763	1033
96	\$317	796	1049
22 54	\$216	581	748
60	\$222	602	779
66	\$235	649	850
72	\$244	669	881
78	\$262	757	1005
84	\$273	778	1042
90	\$281	782	1079
96	\$290	815	1114
33 54	\$287	782	988
60	\$298	819	1033
66	\$313	901	1133
72	\$323	943	1181
78	\$351	1082	1353
84	\$361	1130	1406
90	\$375	1175	1460
96	\$386	1223	1514

Step 5. Frame Configuration

<i>For 7" high (for 42" and 53" high frames only) (07), 11" high (11), 18" high (for 53" high frames only) (18), or 22" high (22)</i>		
E0	any 2 frame widths	+\$0
<i>For 33" high (33) with 54" wide (54)</i>		
F0	1 30"-wide frame, 1 24"-wide frame	+\$0
<i>For 33" high (33) with 60" wide (60)</i>		
H0	2 30"-wide frames	+\$0
J0	1 36"-wide frame, 1 24"-wide frame	+\$0
<i>For 33" high (33) with 66" wide (66)</i>		
K0	1 36"-wide frame, 1 30"-wide frame	+\$0
L0	1 42"-wide frame, 1 24"-wide frame	+\$0
<i>For 33" high (33) with 72" wide (72)</i>		
M0	2 36"-wide frames	+\$0
P0	1 42"-wide frame, 1 30"-wide frame	+\$0
S0	1 48"-wide frame, 1 24"-wide frame	+\$0

Extended-Width Upper Tile *continued*

<i>For 33" high (33) with 78" wide (78)</i>		
U0	1 42"-wide frame, 1 36"-wide frame	+\$0
V0	1 48"-wide frame, 1 30"-wide frame	+\$0

<i>For 33" high (33) with 84" wide (84)</i>		
X0	2 42"-wide frames	+\$0
Z0	1 48"-wide frame, 1 36"-wide frame	+\$0

<i>For 33" high (33) with 90" wide (90)</i>		
40	1 48"-wide frame, 1 42"-wide frame	+\$0

<i>For 33" high (33) with 96" wide (96)</i>		
50	2 48"-wide frames	+\$0

Step 6. Surface Finish

<i>For laminate (L)</i>		
8Q	folkstone grey	+\$0
91	white	+\$0
LU	soft white	+\$0
WL	sandstone	+\$0

<i>For veneer (W)</i>		
2U	light brown walnut <input type="checkbox"/> A	+\$0
40	dark brown walnut	+\$0
ED	aged cherry <input type="checkbox"/> A	+\$0
EK	medium red walnut	+\$0
EW	medium matte walnut	+\$0
ET	clear on ash <input type="checkbox"/> A	+\$0
EU	oak on ash <input type="checkbox"/> A	+\$0
EV	walnut on ash <input type="checkbox"/> A	+\$0
UL	natural maple <input type="checkbox"/> A	+\$0
UX	walnut on cherry <input type="checkbox"/> A	+\$0

Step 7. Horizontal Bead Finish

8Q	folkstone grey	+\$0
91	white	+\$0
98	studio white	+\$0
CL	cool grey neutral	+\$0
G1	graphite	+\$0
LU	soft white	+\$0
MT	medium tone	+\$0
WL	sandstone	+\$0
WN	warm grey neutral	+\$0
CN	metallic champagne	+\$0
EH	metallic bronze	+\$0
MS	metallic silver	+\$0

Step 8. Fabric

<i>For tackable fabric, horizontal (R)</i>					
	07	11	18	22	33
Price Category 1	+\$0	0	0	0	0
Price Category 2	+\$10	13	25	25	37
Price Category 3	+\$20	25	42	42	66
Price Category 4	+\$28	44	66	66	101
Price Category 5	+\$66	85	153	153	222
Price Category B	+\$35	44	76	76	113
Price Category C	+\$52	65	117	116	168
Price Category D	+\$66	82	152	147	222
Price Category E	+\$81	99	184	178	277
Price Category F	+\$117	149	238	238	325
Price Category G	+\$230	230	230	230	230

Upper Power/Data Tile

FT184.

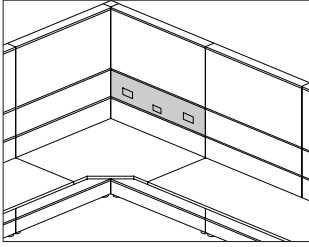

Canvas Office Landscape® Walls

Product Information

Description

This 11"-high tile attaches to 1 side of an equal-width frame. It has a fabric surface, receptacle opening(s), and a communication faceplate location. Covers for power and data openings are included. Each tile has a horizontal bead along the top of the tile. It is UL listed and NFPA classified. Attachment hardware included.

Tile with standard power option (C) has a tackable surface. Tile with Chicago power option (R) is not tackable.

Notes

Specify width of tile to match width of frame.

24"-wide tile with standard power option (C) has 1 receptacle opening only. All other tiles have 2 receptacle openings.

To access power, order upper power/data tile power harness (FT153.) separately.

Order 4-circuit receptacles (FT155. or FT156.) separately.

When using cutouts for hardwired junction boxes (Chicago), specify hardwire mounting rail (FT157.) separately.

When specifying tackable fabric, horizontal option (R), fabric direction is horizontal (railroaded). Specify all tiles within the workstation the same.

Fabric-covered tile accepts Customer's Own Material (COM). Yardage is estimated for directional, 54"-wide fabrics.

For tackable fabric option (T)

Order minimum of 0.50 yard.

For tackable fabric, horizontal option (R)

Width—Yardage

24"—.88

30"—1.05

36"—1.22

42"—1.4

48"—1.58

For information on multiple quantities or nondirectional fabrics, contact COM Department. See Order Information in Appendices.

Dimensions

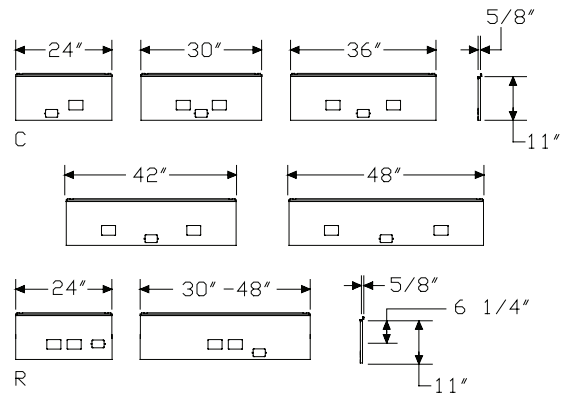

Specification Information

Step 1.
FT184.

Step 2. Width

24	24" wide
30	30" wide
36	36" wide
42	42" wide
48	48" wide

Step 3. Functional Zone

T	fabric
R	fabric, horizontal

Step 4. Cutouts

For fabric (T)

C	power/data cutouts
R	power/data cutouts (meets Chicago electrical code requirements)

For fabric, horizontal (R)

C	power/data cutouts
----------	--------------------

Prices for Steps 1-4.

	C	R
FT184. 24 T	\$133	133
R	\$136	—
30 T	\$142	142
R	\$146	—
36 T	\$150	150
R	\$155	—
42 T	\$161	161
R	\$165	—
48 T	\$169	169
R	\$174	—

Step 5. Horizontal Bead Finish

8Q	folkstone grey	+\$0
91	white	+\$0
98	studio white	+\$0
CL	cool grey neutral	+\$0
G1	graphite	+\$0
LU	soft white	+\$0
MT	medium tone	+\$0
WL	sandstone	+\$0
WN	warm grey neutral	+\$0
CN	metallic champagne	+\$0
EH	metallic bronze	+\$0
MS	metallic silver	+\$0

Step 6. Receptacle Trim Finish

91	white	+\$0
CL	cool grey neutral	+\$0
G1	graphite	+\$0
WN	warm grey neutral	+\$0

Step 7. Surface Finish

See application chart and textiles list for fabric usage and numbers. First 2 digits of number indicate fabric line; remaining digit(s) indicate fabric color.

For fabric (T)

Price Category 1	+\$0
Price Category 2	+\$7
Price Category 3	+\$13
Price Category 4	+\$18
Price Category B	+\$22
Price Category C	+\$33
Price Category D	+\$43
Price Category E	+\$54
Price Category F	+\$80
Price Category G	+\$107

For fabric, horizontal (R)

Price Category 1	+\$0
Price Category 2	+\$7
Price Category 3	+\$13
Price Category 4	+\$18
Price Category 5	+\$43
Price Category B	+\$22
Price Category C	+\$33
Price Category D	+\$43
Price Category E	+\$54
Price Category F	+\$80
Price Category G	+\$107

Off-Module Upper Tile

FT188.

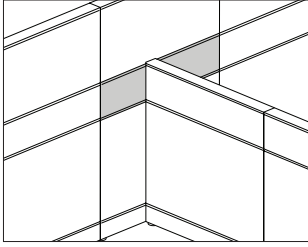

Product Information

Description

This 11"-high tile attaches to 1 side of a frame and is the upper connection point for an off-module 90° connector kit. It is also the attachment point for an off-module shelf, flipper door unit, or sliding door storage unit. Tile has a painted or fabric surface and a horizontal bead along the top. Tile is UL listed and NFPA classified. Attachment hardware included.

Notes

Return frame or overhead storage attaches to off-module tile in 1" intervals. Return frame must be inset at least 2" from either end of frame with off-module tile.

Tile cannot be used with wall strips.

When attaching overhead storage below the top of the frame, specify off-module change-of-height support rail (FT166.) separately.

When connecting a frame of lower height, specify off-module connector kit (FT127.B) and off-module change-of-height support rail (FT166.) separately.

Tile cannot be used for off module placement to a spine wall of a frame with any of the following products:

- Upmount screen (FT113.)
- Frame top screen (FT114.)
- Thin profile stacking window (FT187.)
- Pari screen, frame top (FT355.)

Fabric-covered tile is non-tackable.

When specifying fabric, horizontal option (R), fabric direction is horizontal (railroaded). Specify all tiles within the workstation the same.

Fabric-covered tile accepts Customer's Own Material (COM). Yardage is estimated for directional, 54"-wide fabrics.

For fabric option (F)

Height—Yardage

11"—0.50

For fabric, horizontal option (R)

24"—.88

30"—1.05

36"—1.22

42"—1.4

48"—1.58

For information on multiple quantities or nondirectional fabrics, contact COM department. See Order Information in Appendices.

Dimensions

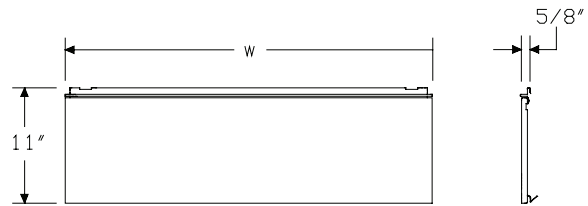

Specification Information

Step 1.

FT188.

Step 2. Width

24	24" wide
30	30" wide
36	36" wide
42	42" wide
48	48" wide

Step 3. Surface Material

P	Painted
F	fabric
R	fabric, horizontal

Prices for Steps 1-3.

	P	F	R
FT188. 24	\$318	438	449
30	\$353	473	487
36	\$400	528	541
42	\$451	579	595
48	\$484	615	634

Step 4. Surface Finish

For painted (P)

Sand Texture Paint

8Q	folkstone grey	+\$0
98	studio white	+\$0
WL	sandstone	+\$0

Bright Sand Texture Paint

91	white	+\$0
CL	cool grey neutral	+\$0
G1	graphite	+\$0
WN	warm grey neutral	+\$0

Metallic Paint

CN	metallic champagne	+\$0
EH	metallic bronze	+\$0
MS	metallic silver	+\$0

Step 5. Horizontal Bead Finish

8Q	folkstone grey	+\$0
91	white	+\$0
98	studio white	+\$0
CL	cool grey neutral	+\$0
G1	graphite	+\$0
LU	soft white	+\$0
MT	medium tone	+\$0
WL	sandstone	+\$0
WN	warm grey neutral	+\$0
CN	metallic champagne	+\$0
EH	metallic bronze	+\$0
MS	metallic silver	+\$0

Step 6. Surface Finish

For fabric (F) or fabric, horizontal (R)

Price Category 1	+\$0
Price Category 2	+\$7
Price Category 3	+\$13
Price Category 4	+\$18
Price Category 5	+\$43
Price Category B	+\$22
Price Category C	+\$33
Price Category D	+\$43
Price Category E	+\$54
Price Category F	+\$0
Price Category G	+\$0

Marker/Eraser Holder

Y7231.

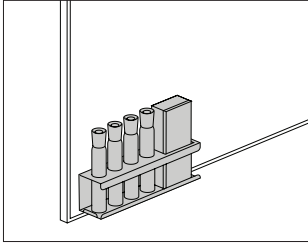

Product Information

Description

This metal holder includes 4 erasable markers and an eraser. It attaches to a vertical surface with hook-and-loop fastener, 2-sided tape, or magnetic tape (also included).

Dimensions

Specification Information

Step 1.

Y7231. \$131

Step 2. Finish

91	white	+\$0
BK	black	+\$0
MS	metallic silver	+\$0

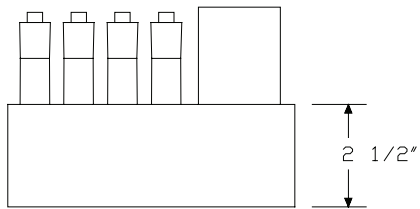
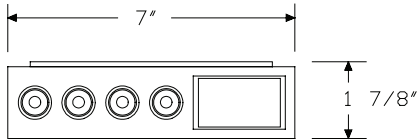

Coat Hook

FT490.

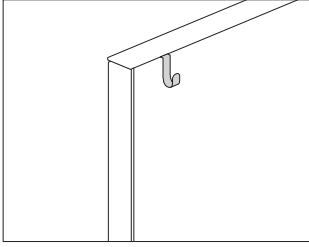

Canvas Office Landscape® Walls

Product Information

Description

This hook fits under the frame's top cap and holds coats, hats, and umbrellas. It can be specified for use with a standard or architectural top cap. Package of 6.

Dimensions

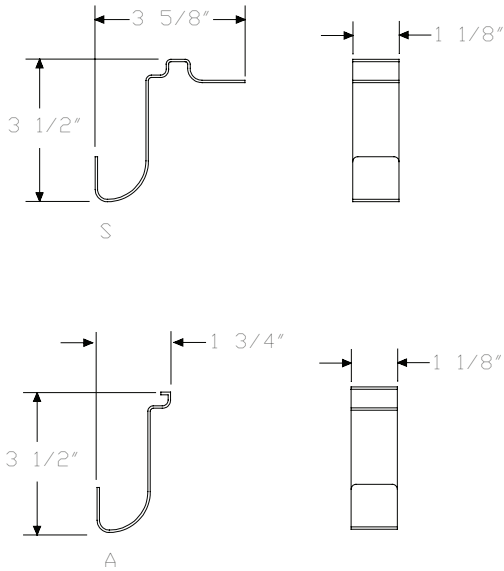

Specification Information

Step 1.

FT490.

Step 2. Type

S for standard top cap

A for architectural top cap A

Prices for Steps 1-2.

FT490. S	\$110
A	\$110

Step 3. Finish

Bright Sand Texture Paint

91	white	+\$0
CL	cool grey neutral	+\$0
G1	graphite	+\$0
WN	warm grey neutral	+\$0
8Q	folkstone grey	+\$0
98	studio white	+\$0
WL	sandstone	+\$0

Metallic Paint

CN	metallic champagne	+\$0
EH	metallic bronze	+\$0
MS	metallic silver	+\$0

Coat Hook - Frame Attached

FT489.

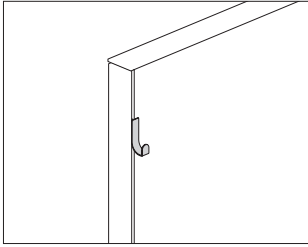

Product Information

Description

This hook attaches using the slotted standards on the frame. Hook holds coats, hats, and umbrellas. It can be specified for use with a standard or architectural top cap, and can be located anywhere on the frame's slots. Package of 6.

Dimensions

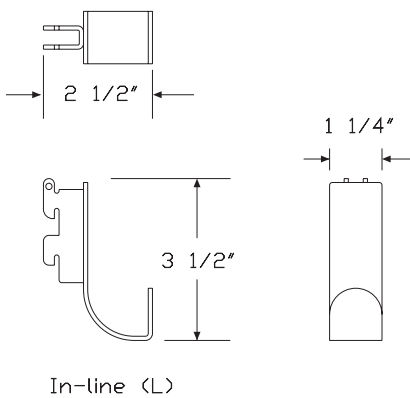
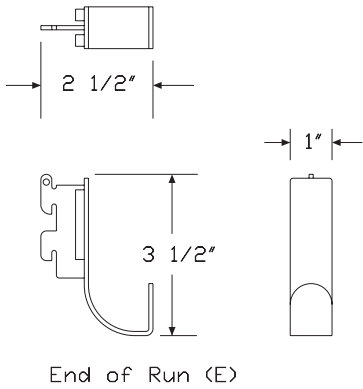

Specification Information

Step 1.

FT489. A

Step 2. Type

L canvas slotted standard attached - in-line A

E canvas slotted standard attached - end of run A

Prices for Steps 1-2.

FT489. L	\$307
E	\$307

Step 3. Surface Finish

Bright Sand Texture Paint

8Q	folkstone grey <input type="checkbox"/> A	+\$0
91	white <input type="checkbox"/> A	+\$0
98	studio white <input type="checkbox"/> A	+\$0
CL	cool grey neutral <input type="checkbox"/> A	+\$0
G1	graphite <input type="checkbox"/> A	+\$0
WL	sandstone <input type="checkbox"/> A	+\$0
WN	warm grey neutral <input type="checkbox"/> A	+\$0

Metallic Paint

CN	metallic champagne <input type="checkbox"/> A	+\$0
EH	metallic bronze <input type="checkbox"/> A	+\$0
MS	metallic silver <input type="checkbox"/> A	+\$0

Rail Tile

FT175.

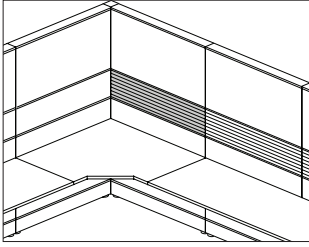

Canvas Office Landscape® Walls

Product Information

Description
This rail tile attaches to 1 side of a frame or wall strips and holds work tools. It has a horizontal bead along the top of the tile. Attachment hardware is included.

Notes

Specify width of tile to match width of frame.
 7"-high tile attaches to the top position of a 42"- or 53"-high frame only.
 Specify top tile position (T) when attaching to the top 11" of a frame.
 Specify middle tile position (M) for all other frame locations. Specify wall strip tile position (W) when attaching to wall strips.
 Work tools cannot attach to bottom rail.
 To retrofit existing rail tiles to support a monitor arm, order monitor arm retrofit kit (FT179.) separately.

Dimensions

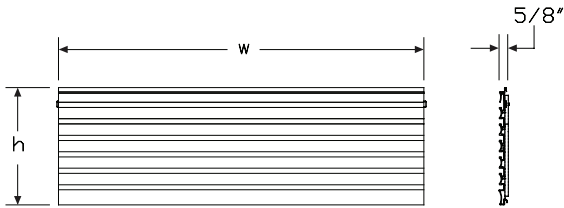

Specification Information

Step 1.

FT175.

Step 2. Height

07	7" high
11	11" high

Step 3. Width

18	18" wide
24	24" wide
30	30" wide
36	36" wide
42	42" wide
48	48" wide

Step 4. Tile Position

For 7" high (07)

T	top
----------	-----

For 11" high (11)

T	top
M	middle
W	wall strip

Prices for Steps 1-4.

		T	M	W
FT175. 07	18	\$157	—	—
	24	\$167	—	—
	30	\$186	—	—
	36	\$203	—	—
	42	\$224	—	—
	48	\$234	—	—
11	18	\$163	145	163
	24	\$169	150	169
	30	\$188	166	188
	36	\$208	182	208
	42	\$226	198	226
	48	\$245	219	245

Step 5. Surface Finish

8Q	folkstone grey <input type="checkbox"/> A	+\$0
98	studio white <input type="checkbox"/> A	+\$0
WL	sandstone <input type="checkbox"/> A	+\$0

Rail Tile *continued*

Bright Sand Texture Paint

91	white	+\$0
CL	cool grey neutral	+\$0
G1	graphite	+\$0
WN	warm grey neutral	+\$0

Metallic Paint

CN	metallic champagne	+\$0
EH	metallic bronze	+\$0
MS	metallic silver	+\$0

Step 6. Horizontal Bead Finish

8Q	folkstone grey	+\$0
91	white	+\$0
98	studio white	+\$0
CL	cool grey neutral	+\$0
G1	graphite	+\$0
LU	soft white	+\$0
MT	medium tone	+\$0
WL	sandstone	+\$0
WN	warm grey neutral	+\$0
CN	metallic champagne	+\$0
EH	metallic bronze	+\$0
MS	metallic silver	+\$0

Upper Monitor Arm Tile

FT178.

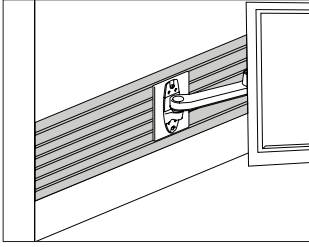

Canvas Office Landscape® Walls

Product Information

Description

This 11"-high rail tile attaches to 1 side of a frame and supports a monitor arm. It also has rails to hold work tools. The monitor arm tile supports up to 3 monitor arms at a maximum of 20 pounds per arm. Each tile has a horizontal bead along the top of the tile and includes attachment hardware.

Notes

Specify width of tile to match width of frame.

Specify "T" option for use at top of frame; specify "M" option for use in middle of frame.

Power harness will not fit in frame location where upper monitor arm tile is attached.

Work tools cannot attach to bottom rail.

Dimensions

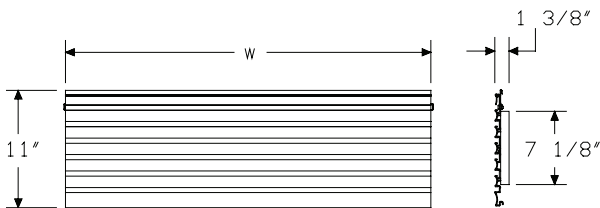

Specification Information

Step 1.

FT178.11

Step 2. Width

24	24" wide
30	30" wide
36	36" wide
42	42" wide
48	48" wide

Step 3. Position in Frame

T	top frame position
M	middle frame position

Prices for Steps 1-3.

		T	M
FT178.11	24	\$337	337
	30	\$370	370
	36	\$407	407
	42	\$446	446
	48	\$490	490

Step 4. Surface Finish

8Q	folkstone grey <input type="checkbox"/> A	+\$0
98	studio white <input type="checkbox"/> A	+\$0
WL	sandstone <input type="checkbox"/> A	+\$0

Bright Sand Texture Paint

91	white	+\$0
CL	cool grey neutral	+\$0
G1	graphite	+\$0
WN	warm grey neutral	+\$0

Metallic Paint

CN	metallic champagne	+\$0
EH	metallic bronze	+\$0
MS	metallic silver	+\$0

Upper Monitor Arm Tile *continued*

Step 5. Horizontal Bead Finish

8Q	folkstone grey	+\$0
91	white	+\$0
98	studio white	+\$0
CL	cool grey neutral	+\$0
G1	graphite	+\$0
LU	soft white	+\$0
MT	medium tone	+\$0
WL	sandstone	+\$0
WN	warm grey neutral	+\$0
CN	metallic champagne	+\$0
EH	metallic bronze	+\$0
MS	metallic silver	+\$0

Monitor Arm Retrofit Kit, Upper Rail Tile FT179.

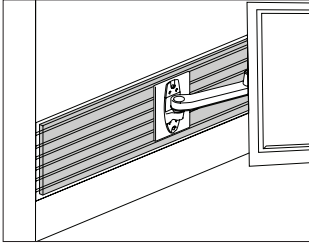

Canvas Office Landscape® Walls

Product Information

Description

This support kit is retrofit to an 11"-high rail tile. It attaches to the back side of the rail tile and allows the tile to support a monitor arm. The retrofit tile supports up to 3 monitor arms at a maximum of 20 pounds per arm. Attachment hardware is included.

Notes

Specify width of kit to match width of rail tile.
 Power harness will not fit in frame location where monitor arm retrofit kit is attached.
 When kit is used on rail tile, work tools cannot attach to bottom rail.

Dimensions

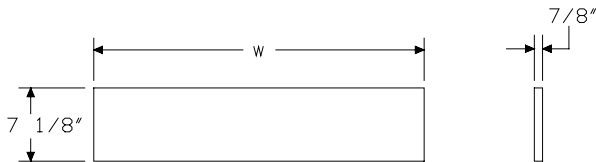

Specification Information

Step 1.

FT179.11

Step 2. Width

- 24** 24" wide
- 30** 30" wide
- 36** 36" wide
- 42** 42" wide
- 48** 48" wide

Prices for Steps 1-2.

FT179.11	24	\$218
	30	\$241
	36	\$263
	42	\$287
	48	\$318

Tool Bar

FT900.

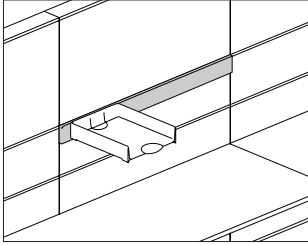

Product Information

Description

This tool bar attaches to a frame or wall strips in 1" increments. It holds paper tools.

Notes

Specify width of tool bar to match width of frame or tool bar can span 2 smaller width frames.

Tool bar cannot attach to the top 3" of a frame.

Dimensions

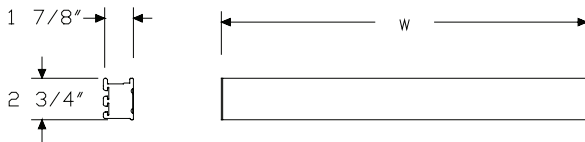

Specification Information

Step 1.

FT900.

Step 2. Width

18	18" wide
24	24" wide
30	30" wide
36	36" wide
42	42" wide
48	48" wide

Prices for Steps 1-2.

FT900. 18	\$62
24	\$65
30	\$77
36	\$86
42	\$96
48	\$102

Step 3. Finish

8Q	folkstone grey <input type="checkbox"/> A	+\$0
91	white	+\$0
98	studio white <input type="checkbox"/> A	+\$0
CL	cool grey neutral	+\$0
CN	metallic champagne	+\$0
EH	metallic bronze	+\$0
G1	graphite	+\$0
MS	metallic silver	+\$0
WL	sandstone <input type="checkbox"/> A	+\$0
WN	warm grey neutral	+\$0

Upper Window Tile

FT183.

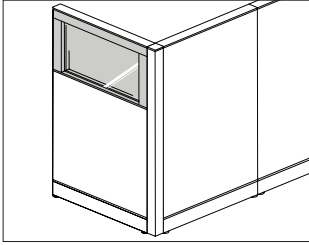

Canvas Office Landscape® Walls

Product Information

Description

This window tile attaches to an equal-width frame and finishes both sides of the frame. It has 1/8"-thick single-pane glass and is used in the top of a base frame or used in a stacking frame. Each tile has a horizontal bead along the top of the tile. Attachment hardware is included.

It cannot be used with wall strips or a power jumper. Stacking frames cannot be used on top of a window tile.

Notes

Specify width of tile to match width of frame.

For thin-profile window, order stacking window (FT187.) separately.

Dimensions

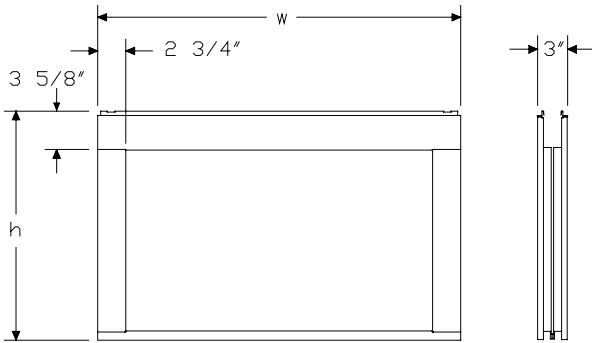

Specification Information

Step 1.

FT183.

Step 2. Height

22	22" high
33	33" high

Step 3. Width

18	18" wide
24	24" wide
30	30" wide
36	36" wide
42	42" wide
48	48" wide

Prices for Steps 1-3.

	18	24	30	36	42	48
FT183. 22	\$306	314	340	366	392	419
33	\$358	365	394	425	453	482

Step 4. Frame Finish

Sand Texture Paint

8Q	folkstone grey <input type="checkbox"/> A	+\$0
98	studio white <input type="checkbox"/> A	+\$0
WL	sandstone <input type="checkbox"/> A	+\$0

Bright Sand Texture Paint

91	white	+\$0
CL	cool grey neutral	+\$0
G1	graphite	+\$0
WN	warm grey neutral	+\$0

Metallic Paint

CN	metallic champagne	+\$0
EH	metallic bronze	+\$0
MS	metallic silver	+\$0

Step 5. Glass Finish

TR	clear	+\$0
34	opal glaze	+\$50

Upper Window Tile *continued*

Step 6. Horizontal Bead Finish

8Q	folkstone grey	+\$0
91	white	+\$0
98	studio white	+\$0
CL	cool grey neutral	+\$0
G1	graphite	+\$0
LU	soft white	+\$0
MT	medium tone	+\$0
WL	sandstone	+\$0
WN	warm grey neutral	+\$0
CN	metallic champagne	+\$0
EH	metallic bronze	+\$0
MS	metallic silver	+\$0

Upper Open Tile

FT185.

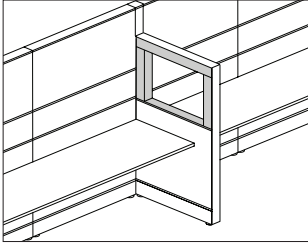

Canvas Office Landscape® Walls

Product Information

Description

This tile finishes an equal-width frame and provides an opening for communicating, sharing equipment, or improving air circulation. 1 tile finishes both sides of the frame. The open tile is used at the top of a base frame or used in a stacking frame. Each tile has a horizontal bead along the top of the tile. Attachment hardware is included.

It cannot be used with wall strips or a power jumper. Stacking frames cannot be used on top of an open tile.

Notes

Specify width of tile to match width of frame.

Dimensions

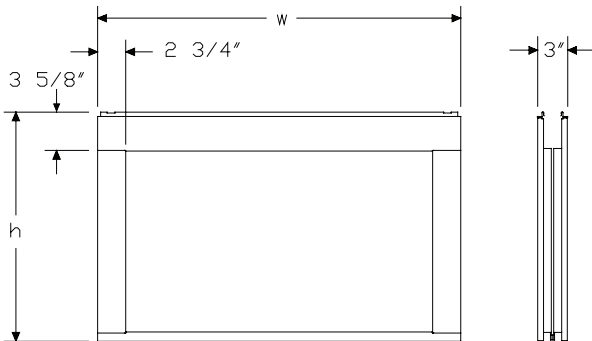

Specification Information

Step 1.

FT185.

Step 2. Height

22	22" high
33	33" high

Step 3. Width

24	24" wide
30	30" wide
36	36" wide
42	42" wide
48	48" wide

Prices for Steps 1-3.

		24	30	36	42	48
FT185. 22		\$279	297	320	342	363
33		\$329	347	363	381	398

Step 4. Frame Finish

8Q	folkstone grey	+\$0
98	studio white	+\$0
WL	sandstone	+\$0

Bright Sand Texture Paint

91	white	+\$0
CL	cool grey neutral	+\$0
G1	graphite	+\$0
WN	warm grey neutral	+\$0

Metallic Paint

CN	metallic champagne	+\$0
EH	metallic bronze	+\$0
MS	metallic silver	+\$0

Step 5. Horizontal Bead Finish

8Q	folkstone grey	+\$0
91	white	+\$0
98	studio white	+\$0
CL	cool grey neutral	+\$0
G1	graphite	+\$0
WL	sandstone	+\$0
WN	warm grey neutral	+\$0
CN	metallic champagne	+\$0
EH	metallic bronze	+\$0
MS	metallic silver	+\$0

Upper Window Tile, Custom Glass FT186.

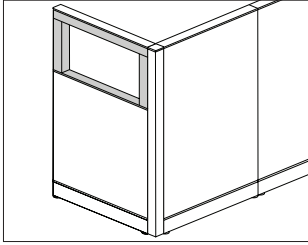

Product Information

Description

This custom-glass window tile attaches to an equal-width frame and finishes both sides of the frame. Each tile has a horizontal bead along the top of the tile. Attachment hardware is included.
 It cannot be used with wall strips or a power jumper. Stacking frames cannot be used on top of a window tile.

Notes

Customers must supply their own glass. Glass must be 1/8"-thick single-pane safety glass. Custom glass will be installed on-site.
 Specify width of tile to match width of frame.
 Custom glass sizes are:

Height—Width—Actual Glass Size

- 22"—24"—18.535"h×18.72"w
- 22"—30"—18.535"h×24.72"w
- 22"—36"—18.535"h×30.72"w
- 22"—42"—18.535"h×36.72"w
- 22"—48"—18.535"h×42.72"w
- 33"—24"—29.535"h×18.72"w
- 33"—30"—29.535"h×24.72"w
- 33"—36"—29.535"h×30.72"w
- 33"—42"—29.535"h×36.72"w
- 33"—48"—29.535"h×42.72"w

Herman Miller, Inc., is not responsible for glass materials that do not meet local building codes.

Dimensions

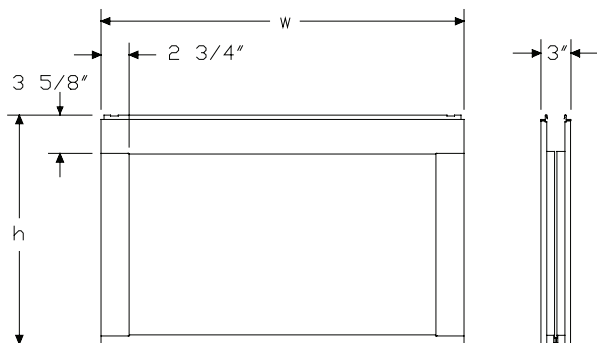

Specification Information

Step 1.

FT186.

Step 2. Height

- 22** 22" high
- 33** 33" high

Step 3. Width

- 24** 24" wide
- 30** 30" wide
- 36** 36" wide
- 42** 42" wide
- 48** 48" wide

Prices for Steps 1-3.

	24	30	36	42	48
FT186. 22	\$274	291	315	337	358
33	\$323	341	358	377	396

Step 4. Frame Finish

- 8Q** folkstone grey +\$0
- 98** studio white +\$0
- WL** sandstone +\$0

Bright Sand Texture Paint

- 91** white +\$0
- CL** cool grey neutral +\$0
- G1** graphite +\$0
- WN** warm grey neutral +\$0

Metallic Paint

- CN** metallic champagne +\$0
- EH** metallic bronze +\$0
- MS** metallic silver +\$0

Upper Window Tile, Custom Glass

continued

Canvas Office Landscape® Walls

Step 5. Horizontal Bead Finish		
8Q	folkstone grey	+\$0
91	white	+\$0
98	studio white	+\$0
CL	cool grey neutral	+\$0
G1	graphite	+\$0
LU	soft white	+\$0
MT	medium tone	+\$0
WL	sandstone	+\$0
WN	warm grey neutral	+\$0
CN	metallic champagne	+\$0
EH	metallic bronze	+\$0
MS	metallic silver	+\$0

Veneer Tile, Matched Set

FT176.

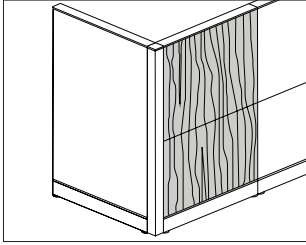

Product Information

Description

This tile set includes 2 veneer tiles that attach to 1 side of a frame. The vertical grain pattern is matched vertically across the tiles. Each tile has a horizontal bead along the top. The set is UL listed and NFPA classified. Attachment hardware included.

Notes

Matched set is intended to cover an entire side of a frame.

Specify matched set height as follows:

- For 46"-high frame, specify 41"-high matched set
- For 57"-high frame, specify 52"-high matched set
- For 68"-high frame, specify 63"-high matched set

Specify width of tile to match width of frame.

The 30"-high tile must always be placed in the bottom position on the frame.

Dimensions

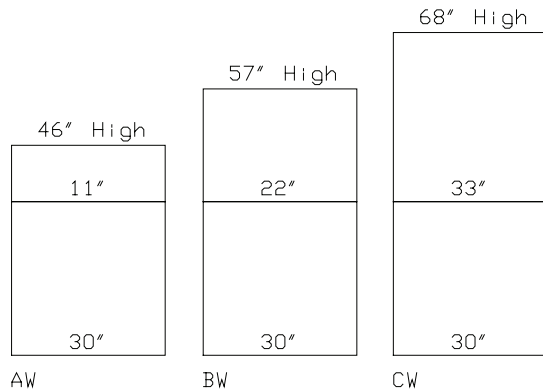

Specification Information

Step 1.

FT176. A

Step 2. Height

- 4** 41" high A
- 5** 52" high A
- 6** 63" high A

Step 3. Width

- 24** 24" wide A
- 30** 30" wide A
- 36** 36" wide A
- 42** 42" wide A
- 48** 48" wide A

Step 4. Tile Configuration

For 41" high (4)

AW 30" high bottom tile, 11" high top tile A

For 52" high (5)

BW 30" high bottom tile, 22" high top tile A

For 63" high (6)

CW 30" high bottom tile, 33" high top tile A

Prices for Steps 1-4.

			AW	BW	CW
FT176. 4	24		\$872	—	—
	30		\$949	—	—
	36		\$1027	—	—
	42		\$1101	—	—
	48		\$1180	—	—
5	24		—	\$1005	—
	30		—	\$1101	—
	36		—	\$1200	—
	42		—	\$1294	—
	48		—	\$1393	—
6	24		—	—	\$1150
	30		—	—	\$1263
	36		—	—	\$1380
	42		—	—	\$1495
	48		—	—	\$1611

Veneer Tile, Matched Set *continued*

Step 5. Surface Finish		
2U	light brown walnut <input type="checkbox"/> A	+\$0
40	dark brown walnut	+\$0
ED	aged cherry <input type="checkbox"/> A	+\$0
EK	medium red walnut	+\$0
EW	medium matte walnut	+\$0
ET	clear on ash <input type="checkbox"/> A	+\$0
EU	oak on ash <input type="checkbox"/> A	+\$0
EV	walnut on ash <input type="checkbox"/> A	+\$0
UL	natural maple <input type="checkbox"/> A	+\$0
UX	walnut on cherry <input type="checkbox"/> A	+\$0

Step 6. Horizontal Bead Finish		
8Q	folkstone grey	+\$0
91	white <input type="checkbox"/> A	+\$0
98	studio white	+\$0
CL	cool grey neutral <input type="checkbox"/> A	+\$0
G1	graphite <input type="checkbox"/> A	+\$0
LU	soft white	+\$0
MT	medium tone	+\$0
WL	sandstone	+\$0
WN	warm grey neutral <input type="checkbox"/> A	+\$0
CN	metallic champagne <input type="checkbox"/> A	+\$0
EH	metallic bronze <input type="checkbox"/> A	+\$0
MS	metallic silver <input type="checkbox"/> A	+\$0

Acoustical Insert

FT189.

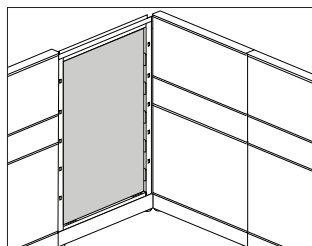

Product Information

Description

This sound-reducing insert is placed within a frame and fills the entire frame or the upper tile zone of a frame. Acoustical inserts are 1 1/2" thick and are positioned in the center of the frame.

The acoustical insert cannot be used with a window tile, open tile, or power/data tile.

Notes

Specify width of insert to match width of frame.

Order frames (FT110.) or stacking frames (FT111.) separately.

Power and data can be routed in the base of a frame that has base covers and an acoustical insert.

Upper zone inserts fill the frame's interior from 35" high to the top of the frame; power harness can be used in any lower zone position. Specify height of upper zone insert to match overall height of frame.

Full-height inserts cannot be used in a frame with a lower or upper power harness.

Acoustical ratings for full-height insert used on frames with base covers are: Noise Reduction Coefficient (NRC) is .75; Sound Transmission Class (STC) is 21.

Dimensions

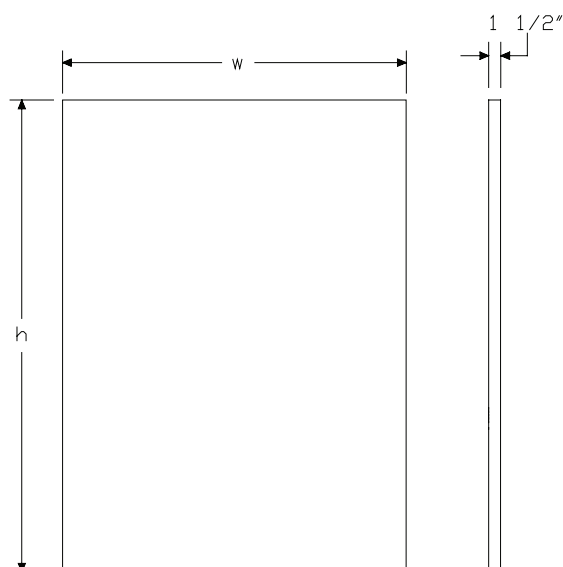

Specification Information

Step 1.

FT189.

Step 2. Application

U upper zone insert

F full-height insert

Step 3. Frame Height

46 46"-high frame

57 57"-high frame

68 68"-high frame

Step 4. Width

18 18" wide

24 24" wide

30 30" wide

36 36" wide

42 42" wide

48 48" wide

Prices for Steps 1-4.

		18	24	30	36	42	48
FT189. U	46	\$55	61	68	75	85	100
	57	\$63	71	79	85	95	110
	68	\$75	81	90	105	123	138
F	46	\$55	61	68	75	85	100
	57	\$63	71	79	85	95	110
	68	\$75	81	90	105	123	138

To-The-Floor Full-Height Tile,
Architectural

FT38A.

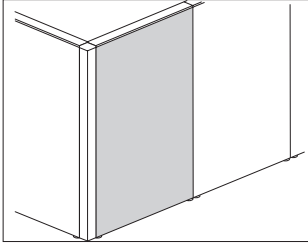

Canvas Office Landscape® Walls

Product Information

Description

This monolithic tile covers 1 side of a frame and extends to the floor concealing the base and eliminating the need for a base cover. It has a tackable fabric surface. Tile is UL listed and NFPA classified. Light seals and attachment hardware included.

Notes

Tile is designed to be used on frame with no base covers (FT110.xxxxx). Specify width of tile to match width of frame. Specify height of tile to match height of frame.

Tackable tiles include base stiffener kit.

When specifying tackable fabric, horizontal (R) option, fabric direction is horizontal (railroaded). Specify all tiles within the workstation the same.

Fabric-covered tile accepts Customer's Own Material (COM). Yardage is estimated for directional, 54"-wide fabrics.

For tackable fabric option (T):

Height—Yardage

42"—1.30

46"—1.40

57"—1.72

68"—2.04

For tackable fabric, horizontal option (R):

Width—Yardage

24"—0.88

30"—1.05

36"—1.22

42"—1.40

48"—1.58

For information on multiple quantities or nondirectional fabrics, contact COM Department. See Order Information in appendices.

Dimensions

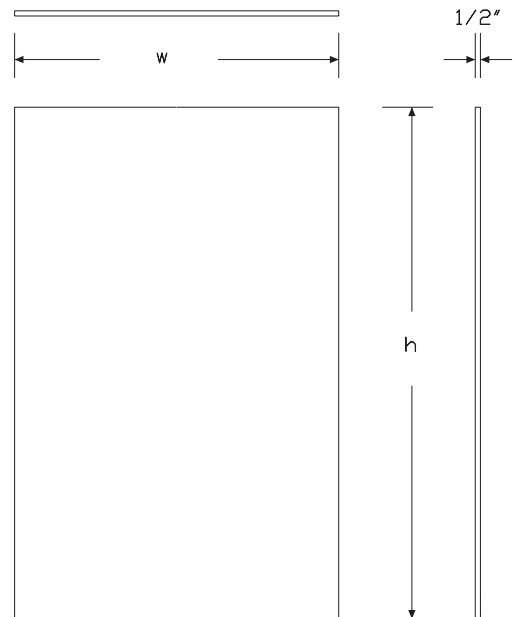

To-The-Floor Full-Height Tile, Architectural *continued*

Specification Information

Step 1.

FT38A.

Step 2. Height

42	42" high
46	46" high
53	53" high
57	57" high
68	68" high

Step 3. Width

18	18" wide
24	24" wide
30	30" wide
36	36" wide
42	42" wide
48	48" wide

Step 4. Surface Material

For 42" high (42) or 46" high (46)

T	tackable fabric
R	tackable fabric, horizontal

For 53" high (53), 57" high (57), or 68" high (68)

T	tackable fabric
----------	-----------------

Prices for Steps 1-4.

	T	R
FT38A. 42 18	\$179	202
24	\$184	209
30	\$193	220
36	\$223	252
42	\$235	265
48	\$244	273
46 18	\$187	213
24	\$192	219
30	\$202	229
36	\$237	266
42	\$248	277
48	\$257	290

53 18	\$193	—
24	\$205	—
30	\$216	—
36	\$252	—
42	\$264	—
48	\$274	—
57 18	\$226	—
24	\$230	—
30	\$243	—
36	\$283	—
42	\$294	—
48	\$310	—
68 18	\$255	—
24	\$262	—
30	\$277	—
36	\$326	—
42	\$344	—
48	\$358	—

Step 5. Fabric

	42T	42R	46T	46R	53T
Price Category 1	+\$0	0	0	0	0
Price Category 2	+\$25	25	31	31	31
Price Category 3	+\$42	42	51	51	51
Price Category 4	+\$66	66	82	82	82
Price Category 5	+\$136	136	169	169	169
Price Category B	+\$69	69	85	85	85
Price Category C	+\$103	103	129	129	129
Price Category D	+\$136	136	169	169	147
Price Category E	+\$169	169	212	212	178
Price Category F	+\$248	248	311	311	230
Price Category G	+\$230	230	230	230	230
			57T	68T	
Price Category 1			+\$0	0	
Price Category 2			+\$31	37	
Price Category 3			+\$51	59	
Price Category 4			+\$82	97	
Price Category 5			+\$169	203	
Price Category B			+\$85	102	
Price Category C			+\$129	150	
Price Category D			+\$169	190	
Price Category E			+\$212	230	
Price Category F			+\$311	297	
Price Category G			+\$230	230	

Full-Height Tile, Architectural with Power and Data FT18D.

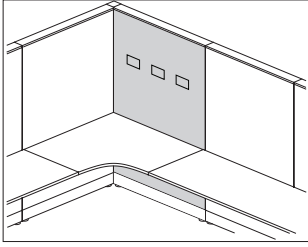

Product Information

Description

This monolithic tile attaches to 1 side of a frame to provide access to power and data. It has a tackable fabric surface. It extends the full height of a frame and ends 4" above the floor. It is UL listed and NFPA classified. Attachment hardware included.

Notes

Specify tile height as follows:

- For 42"-high frame, specify 37"-high (37) tile.
- For 46"-high frame, specify 41"-high (41) tile.
- For 53"-high frame, specify 48"-high (48) tile.
- For 57"-high frame, specify 52"-high (52) tile.
- For 68"-high frame, specify 63"-high (63) tile.

Specify width of tile to match width of frame.

Cutout options have the following power and data cutouts:

- A—2 power cutouts and 1 data cutout above the surface.
- B—2 power cutouts and 1 data cutout above the surface (Chicago).
- C—2 power cutouts and 1 data cutout below the surface.
- E—2 power cutouts and 1 data cutout below the surface (Chicago).

Note: 24"-wide tiles with cutouts for shared power (A and C) have 1 power cutout or 1 power cutout and 1 data cutout.

To access power, order lower power/data tile power harness (FT152.) separately.

Tile with power/data cutouts above work surface (A) includes a communication faceplate extender and covers for the power/data openings.

For tile with cutouts for hardwired junction boxes (Chicago), order hardwire mounting rail (FT157.) separately.

When specifying tackable fabric, horizontal (R) option, fabric direction is horizontal (railroaded). Specify all tiles within the workstation the same.

Fabric-covered tile accepts Customer's Own Material (COM). Yardage is estimated for directional, 54"-wide fabrics.

For tackable fabric option (T):

Height—Yardage

37"—1.26

41"—1.38

52"—1.70

63"—2.00

For tackable fabric, horizontal option (R):

Width—Yardage

24"—0.88

30"—1.05

36"—1.22

42"—1.40

48"—1.58

For information on multiple quantities or nondirectional fabrics, contact COM Department. See Order Information in appendices.

Dimensions

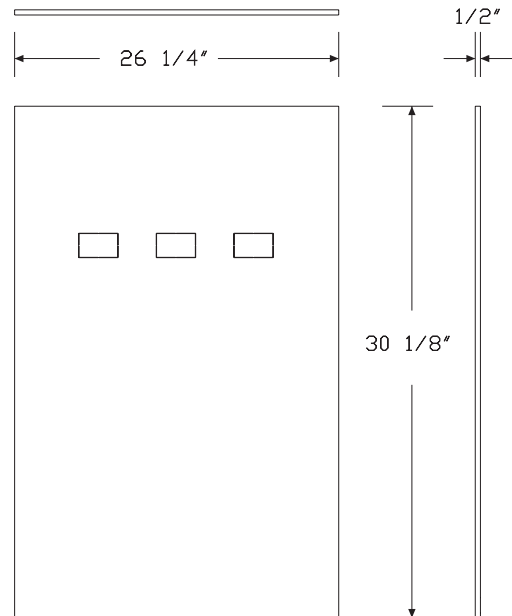

Full-Height Tile, Architectural with Power and Data *continued*

Specification Information

Step 1.

FT18D.

Step 2. Height

37	37" high
41	41" high
48	48" high
52	52" high
63	63" high

Step 3. Width

24	24" wide
30	30" wide
36	36" wide
42	42" wide
48	48" wide

Step 4. Surface Material

For 37" high (37) or 41" high (41)

T	tackable fabric
R	tackable fabric, horizontal

For 48" high (48), 52" high (52), or 63" high (63)

T	tackable fabric
----------	-----------------

Step 5. Cutout Location

A	power/data cutouts above work surface
B	power/data cutouts above work surface (meets Chicago electrical code requirements)
C	power/data cutouts below work surface
E	power/data cutouts below work surface (meets Chicago electrical code requirements)

Prices for Steps 1-5.

	TA	TB	TC	TE	RA	RB
FT18D. 37 24	\$211	211	211	211	214	214
30	\$219	219	219	219	223	223
36	\$252	252	252	252	256	256
42	\$263	263	263	263	267	267
48	\$272	272	272	272	277	277
41 24	\$217	217	217	217	222	222
30	\$230	230	230	230	233	233
36	\$264	264	264	264	268	268
42	\$276	276	276	276	284	284
48	\$289	289	289	289	296	296

48 24	\$219	219	219	219	—	—
30	\$234	234	234	234	—	—
36	\$274	274	274	274	—	—
42	\$286	286	286	286	—	—
48	\$297	297	297	297	—	—
52 24	\$238	238	238	238	—	—
30	\$254	254	254	254	—	—
36	\$299	299	299	299	—	—
42	\$310	310	310	310	—	—
48	\$328	328	328	328	—	—
63 24	\$258	258	258	258	—	—
30	\$276	276	276	276	—	—
36	\$330	330	330	330	—	—
42	\$349	349	349	349	—	—
48	\$366	366	366	366	—	—

	RC	RE
FT18D. 37 24	\$214	214
30	\$223	223
36	\$256	256
42	\$267	267
48	\$277	277
41 24	\$222	222
30	\$233	233
36	\$268	268
42	\$284	284
48	\$296	296

Step 6. Receptacle Trim Finish

8Q	folkstone grey	+\$0
91	white	+\$0
98	studio white	+\$0
CL	cool grey neutral	+\$0
G1	graphite	+\$0
WL	sandstone	+\$0
WN	warm grey neutral	+\$0

Full-Height Tile, Architectural with Power and Data *continued*

Step 7. Fabric					
	37T	37R	41T	41R	48T
Price Category 1	+\$0	0	0	0	0
Price Category 2	+\$22	22	25	25	27
Price Category 3	+\$39	39	42	42	46
Price Category 4	+\$60	60	66	66	74
Price Category 5	+\$124	124	136	136	151
Price Category B	+\$63	63	69	69	77
Price Category C	+\$94	94	103	103	110
Price Category D	+\$124	124	136	136	139
Price Category E	+\$154	154	169	169	168
Price Category F	+\$207	207	227	227	217
Price Category G	+\$269	269	294	294	299
			52T	63T	
Price Category 1			+\$0	0	
Price Category 2			+\$31	37	
Price Category 3			+\$51	59	
Price Category 4			+\$82	97	
Price Category 5			+\$169	203	
Price Category B			+\$85	102	
Price Category C			+\$129	153	
Price Category D			+\$169	203	
Price Category E			+\$212	252	
Price Category F			+\$279	328	
Price Category G			+\$363	427	

Rectangular Surface

FTE10.
FTS10.
FTT10.

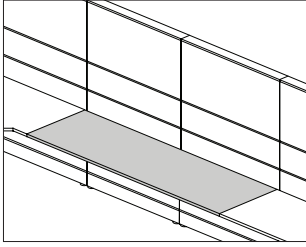

Product Information

Description

This surface hangs from a frame, wall strips, or attaches to various support components to create a freestanding rectangular desk. It has a laminate top and thermoplastic edge, laminate top with a thermoplastic backed plywood edge, veneer top and edge, or painted top and edge. Laminate and veneer surfaces are 1/4" thick. Painted Formcoat® surfaces are 1" thick. When hanging from a frame or wall strips there is a 1" gap at the back of the surface for standard plug head and cord passage.

Notes

For additional size, shape, cable management, and finish options, see Vary Easy Program in Appendices.

For surface attachment bracket (D) option:

- Ganging brackets are included for using the surface as a bridge.
- Surface will only attach to front edge of squared-edge surfaces or the transition portion of the thin-edge or eased-edge surfaces.

For Canvas frame attached surface (F) option:

- Order appropriate supports separately; 2 supports are required for each surface (left and right side):
 - Open support, tapered foot, frame attached (FT294.)
 - Open support, architectural foot, frame attached (FT2A1.)
 - Support panel, tapered foot, frame attached (FT291.)
 - Support panel, frame attached (FT2E2.)
 - Universal post leg, frame attached (FT2B1.)
 - Surface cantilever (FT290.)
 - Surface support rail (FT295.)
 - Support pedestal

- Center supports are included for surfaces 54" wide and wider.

For no brackets, for freestanding or use with low credenza (S) option:

- Order the following support products separately:
 - Closed support leg (FV2E2.)
 - Open support leg, architectural foot (FV2A2.)
 - Square open support leg (FV2D2.)
 - Support leg, post (FV689.)
 - Universal post leg (FT2B2.)
 - Surface ganging bracket (FT29B.)
 - Surface support, low credenza, adjustable height (FT299.)
 - Surface support, low credenza, fixed height (FT298.)
 - Surface-attached pedestal
- When creating a freestanding desk with closed support leg (FV2E2.), a modesty panel (FV697.) is required for stability.

Thin-edge surfaces do not work with the following:

- Surface-attached pedestal
- Support pedestal
- Closed support leg (FV2E2.)
- Square open support leg (FV2D2.)

Stiffener (FV696.) is required for any laminate or veneer surface 54" wide or wider and painted formcoat surfaces 48" wide or wider that cannot use a center cantilever. See Canvas Office Landscape® Planning Guide for specific stiffener guidelines.

Dimensions

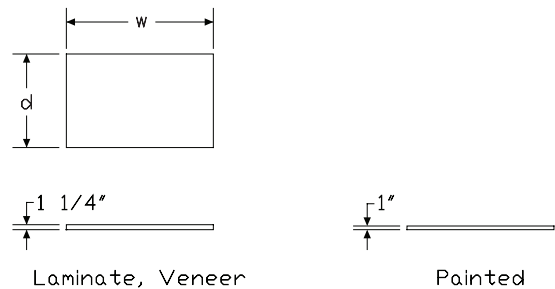

Rectangular Surface *continued*

Specification Information	
Step 1.	
FT	
Step 2. Edge	
S10.	squared-edge
T10.	thin-edge
E10.	eased-edge
Step 3. Depth	
<i>For squared-edge (S10.)</i>	
20	20" deep
24	24" deep
30	30" deep
36	36" deep
<i>For thin-edge (T10.) or eased-edge (E10.)</i>	
24	24" deep
30	30" deep
36	36" deep
Step 4. Width	
<i>For 20" deep (20), 24" deep (24), or 30" deep (30)</i>	
24	24" wide
30	30" wide
36	36" wide
42	42" wide
48	48" wide
54	54" wide
60	60" wide
66	66" wide
72	72" wide
78	78" wide
84	84" wide
90	90" wide
96	96" wide
<i>For 36" deep (36)</i>	
60	60" wide <input type="checkbox"/>
66	66" wide <input type="checkbox"/>
72	72" wide <input type="checkbox"/>
78	78" wide <input type="checkbox"/>
84	84" wide <input type="checkbox"/>
90	90" wide <input type="checkbox"/>
96	96" wide <input type="checkbox"/>

Step 5. Surface Material	
<i>For squared-edge (S10.)</i>	
L	laminate top/thermoplastic edge
W	veneer top/veneer edge <input type="checkbox"/>
P	painted Formcoat® top/edge
U	laminate top/universal edge <input type="checkbox"/>
<i>For thin-edge (T10.)</i>	
L	laminate top/thermoplastic edge
W	veneer top/veneer edge <input type="checkbox"/>
P	painted Formcoat® top/edge
<i>For eased-edge (E10.)</i>	
P	painted Formcoat® top/edge
Step 6. Attachment Bracket	
<i>For 20" deep (20) with 24" wide (24), 30" wide (30), 66" wide (66), 72" wide (72), 78" wide (78), 84" wide (84), 90" wide (90), or 96" wide (96)</i>	
F	Canvas frame attached surface
<i>For 20" deep (20) with 36" wide (36), 42" wide (42), 48" wide (48), 54" wide (54), or 60" wide (60)</i>	
D	surface attachment bracket
F	Canvas frame attached surface
<i>For 24" deep (24) or 30" deep (30) with 24" wide (24) or 30" wide (30)</i>	
F	Canvas frame attached surface
S	no brackets, for freestanding or use with low credenza
<i>For 24" deep (24) or 30" deep (30) with 36" wide (36), 42" wide (42), 48" wide (48), or 54" wide (54)</i>	
D	surface attachment bracket
F	Canvas frame attached surface
S	no brackets, for freestanding or use with low credenza
<i>For 24" deep (24) or 30" deep (30) with 60" wide (60)</i>	
D	surface attachment bracket
F	Canvas frame attached surface
S	no brackets, for freestanding or use with low credenza
<i>For 24" deep (24) or 30" deep (30) with 66" wide (66), 72" wide (72), 78" wide (78), 84" wide (84), 90" wide (90), or 96" wide (96)</i>	
F	Canvas frame attached surface
S	no brackets, for freestanding or use with low credenza

Rectangular Surface *continued*

For 36" deep (36) with 60" wide (60), 66" wide (66), 72" wide (72), 78" wide (78), 84" wide (84), 90" wide (90), or 96" wide (96)

S no brackets, for freestanding or use with low credenza

Prices for Steps 1-6.

	LD	LF	LS	WD	WF	WS
FTS10. 20 24	—	\$180	—	—	422	—
30	—	\$202	—	—	473	—
36	\$219	229	—	513	524	—
42	\$242	253	—	564	576	—
48	\$268	278	—	606	619	—
54	\$317	327	—	697	709	—
60	\$356	367	—	785	798	—
66	—	\$408	—	—	889	—
72	—	\$451	—	—	978	—
78	—	\$492	—	—	1059	—
84	—	\$548	—	—	1141	—
90	—	\$564	—	—	1193	—
96	—	\$588	—	—	1227	—
24 24	—	\$180	137	—	422	373
30	—	\$202	161	—	473	426
36	\$219	229	186	513	524	476
42	\$242	253	210	564	576	528
48	\$268	278	236	606	619	571
54	\$317	327	285	697	709	662
60	\$356	367	314	785	798	738
66	—	\$408	356	—	889	829
72	—	\$451	398	—	978	917
78	—	\$492	450	—	1059	1011
84	—	\$548	506	—	1141	1059
90	—	\$564	512	—	1193	1102
96	—	\$588	514	—	1227	1145
30 24	—	\$197	156	—	468	421
30	—	\$247	204	—	570	523
36	\$275	286	243	627	638	591
42	\$313	323	280	695	707	659
48	\$350	362	319	773	784	737
54	\$415	426	384	889	900	853
60	\$461	472	418	992	1015	955
66	—	\$532	479	—	1137	1077
72	—	\$591	537	—	1255	1196
78	—	\$631	589	—	1332	1285
84	—	\$680	626	—	1409	1361
90	—	\$719	652	—	1478	1413
96	—	\$751	678	—	1547	1463

36 60	—	—	\$524	—	—	1171	
66	—	—	\$602	—	—	1325	
72	—	—	\$677	—	—	1474	
78	—	—	\$684	—	—	1515	
84	—	—	\$692	—	—	1556	
90	—	—	\$737	—	—	1641	
96	—	—	\$782	—	—	1724	
		PD	PF	PS	UD	UF	US
FTS10. 20 24	—	\$207	—	—	180	—	—
30	—	\$234	—	—	202	—	—
36	\$306	264	—	219	229	—	—
42	\$333	291	—	242	253	—	—
48	\$364	321	—	268	278	—	—
54	\$419	377	—	317	327	—	—
60	\$465	422	—	356	367	—	—
66	—	\$471	—	—	408	—	—
72	—	\$520	—	—	451	—	—
78	—	\$567	—	—	492	—	—
84	—	\$631	—	—	548	—	—
90	—	\$649	—	—	564	—	—
96	—	\$676	—	—	588	—	—
24 24	—	\$207	165	—	180	137	—
30	—	\$234	191	—	202	161	—
36	\$306	264	222	219	229	186	—
42	\$333	291	248	242	253	210	—
48	\$364	321	278	268	278	236	—
54	\$419	377	334	317	327	285	—
60	\$465	422	380	356	367	314	—
66	—	\$471	429	—	408	356	—
72	—	\$520	477	—	451	398	—
78	—	\$567	525	—	492	450	—
84	—	\$631	589	—	548	506	—
90	—	\$649	606	—	564	512	—
96	—	\$676	633	—	588	514	—

Canvas Office Landscape® Work Surfaces

Rectangular Surface *continued*

Canvas Office Landscape® Work Surfaces

30 24	—	\$228	185	—	197	156
30	—	\$285	242	—	247	204
36	\$372	329	287	275	286	243
42	\$414	372	329	313	323	280
48	\$457	415	373	350	362	319
54	\$532	489	447	415	426	384
60	\$585	542	500	461	472	418
66	—	\$611	570	—	532	479
72	—	\$680	637	—	591	537
78	—	\$726	683	—	631	589
84	—	\$782	739	—	680	626
90	—	\$826	784	—	719	652
96	—	\$865	823	—	751	678
36 60	—	—	\$626	—	—	524
66	—	—	\$718	—	—	602
72	—	—	\$803	—	—	677
78	—	—	\$836	—	—	684
84	—	—	\$870	—	—	692
90	—	—	\$920	—	—	737
96	—	—	\$973	—	—	782

30 24	—	\$276	234	—	560	514
30	—	\$347	305	—	684	636
36	\$443	400	359	813	767	720
42	\$494	452	410	896	849	801
48	\$548	506	464	988	941	894
54	\$638	596	553	1128	1081	1033
60	\$701	659	617	1265	1217	1169
66	—	\$743	700	—	1364	1316
72	—	\$825	783	—	1506	1459
78	—	\$883	840	—	1599	1552
84	—	\$950	907	—	1691	1644
90	—	\$1003	960	—	1773	1726
96	—	\$1052	1010	—	1857	1809
36 60	—	—	\$654	—	—	1436
66	—	—	\$748	—	—	1619
72	—	—	\$837	—	—	1797
78	—	—	\$873	—	—	1875
84	—	—	\$907	—	—	1953
90	—	—	\$960	—	—	2054
96	—	—	\$1014	—	—	2155

	LD	LF	LS	WD	WF	WS
FTT10. 24 24	—	\$251	209	—	504	456
30	—	\$283	241	—	568	520
36	\$363	320	277	676	628	581
42	\$397	354	313	738	691	644
48	\$433	390	347	789	741	694
54	\$500	457	415	899	852	805
60	\$555	514	471	1004	957	910
66	—	\$573	530	—	1066	1019
72	—	\$631	589	—	1175	1126
78	—	\$689	647	—	1270	1223
84	—	\$765	724	—	1370	1323
90	—	\$788	745	—	1432	1384
96	—	\$822	779	—	1472	1424

	PD	PF	PS	UD	UF	US
FTT10. 24 24	—	\$222	179	—	—	—
30	—	\$248	206	—	—	—
36	\$323	280	238	—	—	—
42	\$352	311	268	—	—	—
48	\$385	342	300	—	—	—
54	\$444	401	360	—	—	—
60	\$491	449	406	—	—	—
66	—	\$501	458	—	—	—
72	—	\$553	512	—	—	—
78	—	\$604	561	—	—	—
84	—	\$672	628	—	—	—
90	—	\$690	648	—	—	—
96	—	\$721	678	—	—	—

Rectangular Surface *continued*

30	24	—	\$242	199	—	—	—
30		—	\$304	262	—	—	—
36		\$393	350	309	—	—	—
42		\$439	396	353	—	—	—
48		\$485	443	400	—	—	—
54		\$564	522	479	—	—	—
60		\$620	578	535	—	—	—
66		—	\$651	608	—	—	—
72		—	\$724	681	—	—	—
78		—	\$773	731	—	—	—
84		—	\$832	790	—	—	—
90		—	\$879	836	—	—	—
96		—	\$920	878	—	—	—
36	60	—	—	\$668	—	—	—
66		—	—	\$763	—	—	—
72		—	—	\$855	—	—	—
78		—	—	\$891	—	—	—
84		—	—	\$927	—	—	—
90		—	—	\$981	—	—	—
96		—	—	\$1035	—	—	—

		PD	PF	PS	UD	UF	US
FTE10.	24 24	—	\$229	185	—	—	—
	30	—	\$258	214	—	—	—
	36	\$334	290	246	—	—	—
	42	\$365	321	277	—	—	—
	48	\$398	354	311	—	—	—
	54	\$458	415	371	—	—	—
	60	\$509	466	422	—	—	—
	66	—	\$519	475	—	—	—
	72	—	\$572	528	—	—	—
	78	—	\$625	581	—	—	—
	84	—	\$694	650	—	—	—
	90	—	\$714	670	—	—	—
	96	—	\$744	700	—	—	—

30	24	—	\$250	207	—	—	—
30		—	\$315	271	—	—	—
36		\$406	363	319	—	—	—
42		\$453	410	366	—	—	—
48		\$501	457	414	—	—	—
54		\$583	539	495	—	—	—
60		\$642	598	554	—	—	—
66		—	\$674	630	—	—	—
72		—	\$747	703	—	—	—
78		—	\$800	756	—	—	—
84		—	\$861	818	—	—	—
90		—	\$909	865	—	—	—
96		—	\$952	908	—	—	—
36	60	—	—	\$691	—	—	—
66		—	—	\$789	—	—	—
72		—	—	\$885	—	—	—
78		—	—	\$921	—	—	—
84		—	—	\$957	—	—	—
90		—	—	\$1015	—	—	—
96		—	—	\$1070	—	—	—

Step 7.

Top Finish		
<i>For laminate top/thermoplastic edge (L) or laminate top/universal edge (U)</i>		
8Q	folkstone grey	+\$0
91	white	+\$0
98	studio white	+\$0
CL	cool grey neutral	+\$0
HF	inner tone light A	+\$0
HT	inner tone A	+\$0
LU	soft white	+\$0
WL	sandstone	+\$0
WN	warm grey neutral	+\$0
76	light brown walnut	+\$0
HM	natural maple	+\$0
HP	light anigre	+\$0
HX	aged cherry	+\$0
HY	walnut on cherry	+\$0
LA	light ash A	+\$0
LBA	clear on ash	+\$0
LBR	phantom ecru	+\$0
LBS	phantom cocoa	+\$0
LBU	medium matte walnut	+\$0
LBV	warm grey teak	+\$0
LBB	oak on ash	+\$0

Rectangular Surface *continued*

LBC	walnut on ash	+\$0
LBD	dark brown walnut	+\$0
LBE	medium red walnut	+\$0
OG	honey maple <input type="checkbox"/> A	+\$0
LBF	neutral twill	+\$0
LBG	sarum twill	+\$0
LBH	earthen twill	+\$0
LBJ	graphite twill	+\$0
LBQ	white twill	+\$0
LBK	pewter mesh	+\$0
LBL	steel mesh	+\$0
LBM	crisp linen	+\$0
LBN	classic linen	+\$0
LBP	casual linen	+\$0

Top/Edge Finish: Wood Veneer

For veneer top/veneer edge (W)

2U	light brown walnut <input type="checkbox"/> A	+\$85
40	dark brown walnut <input type="checkbox"/> A	+\$85
ED	aged cherry <input type="checkbox"/> A	+\$85
EK	medium red walnut <input type="checkbox"/> A	+\$85
EW	medium matte walnut <input type="checkbox"/> A	+\$85
ET	clear on ash <input type="checkbox"/> A	+\$85
EU	oak on ash <input type="checkbox"/> A	+\$85
EV	walnut on ash <input type="checkbox"/> A	+\$85
UL	natural maple <input type="checkbox"/> A	+\$85
UX	walnut on cherry <input type="checkbox"/> A	+\$85

Top/Edge Finish: Opaque Formcoat®

For painted Formcoat® top/edge (P)

8Q	folkstone grey	+\$0
91	white	+\$0
CL	cool grey neutral	+\$0
LU	soft white	+\$0
WL	sandstone	+\$0
WN	warm grey neutral	+\$0

Step 8. Edge Finish

For laminate top/thermoplastic edge (L)

76	light brown walnut	+\$0
8Q	folkstone grey	+\$0
91	white	+\$0
98	studio white	+\$0
CL	cool grey neutral	+\$0
LA	light ash	+\$0
LBA	clear on ash	+\$0

LBR	phantom ecru	+\$0
LBS	phantom cocoa	+\$0
LBU	medium matte walnut	+\$0
LBV	warm grey teak	+\$0
LBB	oak on ash	+\$0
LBC	walnut on ash	+\$0
LBD	dark brown walnut	+\$0
LBE	medium red walnut	+\$0
LBF	neutral twill	+\$0
LBG	sarum twill	+\$0
LBH	earthen twill	+\$0
LBJ	graphite twill	+\$0
LBK	pewter mesh	+\$0
LBL	steel mesh	+\$0
LBM	crisp linen	+\$0
LBN	classic linen	+\$0
LBP	casual linen	+\$0
LBQ	white twill	+\$0
WL	sandstone	+\$0
WN	warm grey neutral	+\$0
HF	inner tone light	+\$0
HM	natural maple	+\$0
HP	light anigre	+\$0
HT	inner tone	+\$0
HX	aged cherry	+\$0
HY	walnut on cherry	+\$0
LU	soft white	+\$0
OG	honey maple	+\$0

For laminate top/universal edge (U)

PLY	plywood edge <input type="checkbox"/> A	+\$50
------------	---	-------

Concave Rectangular Surface

FTE11.
FTS11.
FTT11.

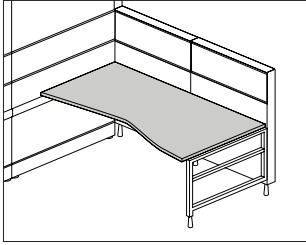

Product Information

Description

This wall-attached surface hangs perpendicular to a spine wall and is used in an About Face™ work surface orientation. It has a laminate top and thermoplastic edge, a veneer top and edge or a painted top and edge. Laminate and veneer surfaces are 1/4" thick. Painted Formcoat® surfaces are 1" thick. There is a 1" gap at the back of the surface for standard plug head and cord passage.

Notes

For additional size, shape, cable management, and finish options, see Vary Easy Program in Appendices.

36"-deep end must be on aisle side of workstation.

To support 36"-deep end of surface on aisle side, order 1 of the following products separately:

- 36"-wide or wider frame with surface support rail (FT295.)
- 36"-deep open support, tapered foot, frame attached (FT294.36)
- 36"-deep open support, architectural foot, frame attached (FT2A1.36)
- Universal post leg, frame attached (FT2B1.)

To support 33 7/16" end of surface, order one of the following separately:

- Support rail (FT295.) Support rail must match width of attaching frame.
- Bookcase surface support (FT293.) with bookcase (MJ420., MJ42B.) or bookshelf (MJ420.)

Center surface supports are included.

Thin-edge and eased-edge surfaces do not work with bookcase surface support (FT293.).

Stiffener (FV696.) is required for any laminate or veneer surface 54" wide or wider and painted formcoat surfaces 48" wide or wider that cannot use a center cantilever. See Canvas Office Landscape® Planning Guide for specific stiffener guidelines.

Dimensions

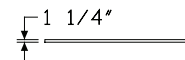
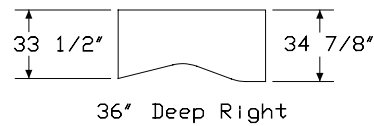
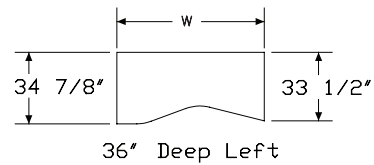

Laminate, Veneer



Painted

Concave Rectangular Surface

continued

Canvas Office Landscape® Work Surfaces

Specification Information				
Step 1.				
FT				
Step 2. Edge				
S11.	squared-edge			
T11.	thin-edge			
E11.	eased-edge			
Step 3. Depth				
3L	36" deep left			
3R	36" deep right			
Step 4. Width				
72	72" wide			
78	78" wide			
84	84" wide			
90	90" wide			
96	96" wide			
Step 5. Surface Material				
<i>For squared-edge (S11.)</i>				
L	lamine top/thermoplastic edge			
W	veneer top/veneer edge A			
P	painted Formcoat® top/edge			
<i>For thin-edge (T11.)</i>				
L	lamine top/thermoplastic edge			
W	veneer top/veneer edge A			
P	painted Formcoat® top/edge			
<i>For eased-edge (E11.)</i>				
P	painted Formcoat® top/edge			
Step 6. Attachment				
F	Canvas frame attached surface			
Prices for Steps 1-6.				
		LF	WF	PF
FTS11.	3L 72	\$901	1502	1037
	78	\$960	1595	1105
	84	\$1019	1686	1171
	90	\$1075	1768	1236
	96	\$1129	1852	1300

	3R 72	\$901	1502	1037
	78	\$960	1595	1105
	84	\$1019	1686	1171
	90	\$1075	1768	1236
	96	\$1129	1852	1300
FTT11.	3L 72	\$1248	1784	1093
	78	\$1331	1894	1165
	84	\$1411	2003	1236
	90	\$1488	2099	1303
	96	\$1564	2200	1370
	3R 72	\$1248	1784	1093
	78	\$1331	1894	1165
	84	\$1411	2003	1236
	90	\$1488	2099	1303
	96	\$1564	2200	1370
FTE11.	3L 72	—	—	\$1131
	78	—	—	\$1205
	84	—	—	\$1278
	90	—	—	\$1348
	96	—	—	\$1418
	3R 72	—	—	\$1131
	78	—	—	\$1205
	84	—	—	\$1278
	90	—	—	\$1348
	96	—	—	\$1418
Step 7.				
Top Finish				
<i>For laminate top/thermoplastic edge (L)</i>				
8Q	folkstone grey			+\$0
91	white			+\$0
98	studio white			+\$0
CL	cool grey neutral			+\$0
HF	inner tone light A			+\$0
HT	inner tone A			+\$0
LU	soft white			+\$0
WL	sandstone			+\$0
WN	warm grey neutral			+\$0
76	light brown walnut			+\$0
HM	natural maple			+\$0
HP	light anigre			+\$0
HX	aged cherry			+\$0
HY	walnut on cherry			+\$0
LA	light ash A			+\$0

Concave Rectangular Surface

continued

LBA	clear on ash	+\$0	91	white	+\$0
LBR	phantom ecru	+\$0	98	studio white	+\$0
LBS	phantom cocoa	+\$0	CL	cool grey neutral	+\$0
LBU	medium matte walnut	+\$0	LA	light ash	+\$0
LBV	warm grey teak	+\$0	LBA	clear on ash	+\$0
LBB	oak on ash	+\$0	LBR	phantom ecru	+\$0
LBC	walnut on ash	+\$0	LBS	phantom cocoa	+\$0
LBD	dark brown walnut	+\$0	LBU	medium matte walnut	+\$0
LBE	medium red walnut	+\$0	LBV	warm grey teak	+\$0
OG	honey maple <input type="checkbox"/> A	+\$0	LBB	oak on ash	+\$0
LBF	neutral twill	+\$0	LBC	walnut on ash	+\$0
LBG	sarum twill	+\$0	LBD	dark brown walnut	+\$0
LBH	earthen twill	+\$0	LBE	medium red walnut	+\$0
LBJ	graphite twill	+\$0	LBF	neutral twill	+\$0
LBQ	white twill	+\$0	LBG	sarum twill	+\$0
LBK	pewter mesh	+\$0	LBH	earthen twill	+\$0
LBL	steel mesh	+\$0	LBJ	graphite twill	+\$0
LBM	crisp linen	+\$0	LBK	pewter mesh	+\$0
LBN	classic linen	+\$0	LBL	steel mesh	+\$0
LBP	casual linen	+\$0	LBM	crisp linen	+\$0
			LBN	classic linen	+\$0
			LBP	casual linen	+\$0
			LBQ	white twill	+\$0
			WL	sandstone	+\$0
			WN	warm grey neutral	+\$0
			HF	inner tone light	+\$0
			HM	natural maple	+\$0
			HP	light anigre	+\$0
			HT	inner tone	+\$0
			HX	aged cherry	+\$0
			HY	walnut on cherry	+\$0
			LU	soft white	+\$0
			OG	honey maple	+\$0

Top/Edge Finish: Wood Veneer

For veneer top/veneer edge (W)

2U	light brown walnut <input type="checkbox"/> A	+\$95
40	dark brown walnut <input type="checkbox"/> A	+\$95
ED	aged cherry <input type="checkbox"/> A	+\$95
EK	medium red walnut <input type="checkbox"/> A	+\$95
EW	medium matte walnut <input type="checkbox"/> A	+\$95
ET	clear on ash <input type="checkbox"/> A	+\$95
EU	oak on ash <input type="checkbox"/> A	+\$95
EV	walnut on ash <input type="checkbox"/> A	+\$95
UL	natural maple <input type="checkbox"/> A	+\$95
UX	walnut on cherry <input type="checkbox"/> A	+\$95

Top/Edge Finish: Opaque Formcoat®

For painted Formcoat® top/edge (P)

8Q	folkstone grey	+\$0
91	white	+\$0
CL	cool grey neutral	+\$0
LU	soft white	+\$0
WL	sandstone	+\$0
WN	warm grey neutral	+\$0

Step 8. Edge Finish

For laminate top/thermoplastic edge (L)

76	light brown walnut	+\$0
8Q	folkstone grey	+\$0

Bowtie Rectangular Surface

FTE18.
FTS18.
FTT18.

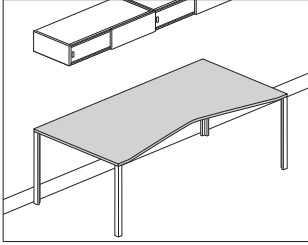

Canvas Office Landscape® Work Surfaces

Product Information

Description

This surface has a centered, non-handed concave cutout and attaches to various support components to create a freestanding concave rectangular desk. It has a laminate top and thermoplastic edge, a veneer top and edge, or a painted top and edge. Laminate and veneer surfaces are 1 1/4" thick. Painted Formcoat® surfaces are 1" thick.

Notes

For additional size, shape, cable management, and finish options, see Vary Easy Program in Appendices.

Order the following support products separately:

- Closed support leg (FV2E2.)
- Open support leg, architectural foot (FV2A2.)
- Square open support leg (FV2D2.)
- Support leg, post (FV689.)
- Universal post leg (FT2B2.)
- Surface support, low credenza, adjustable height (FT299.)
- Surface support, low credenza, fixed height (FT298.)

Thin-edge surfaces do not work with the following:

- Closed support leg (FV2E2.)
- Square open support leg (FV2D2.)

When creating a freestanding desk with closed support leg (FV2E2.), a modesty panel (FV697.) is required for stability.

Stiffener (FV696.) is required for any laminate or veneer surface 54" wide or wider and painted formcoat surfaces 48" wide or wider that cannot use a center cantilever. See Canvas Office Landscape® Planning Guide for specific stiffener guidelines.

Dimensions

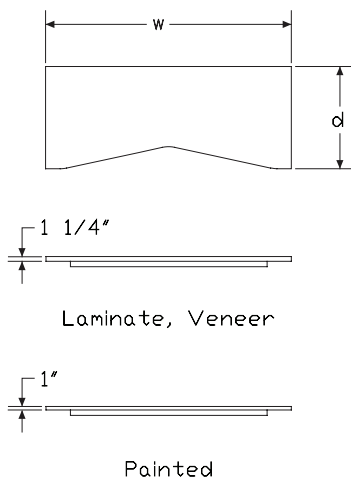

Specification Information

Step 1.

FT

Step 2. Edge

- S18.** squared-edge
- T18.** thin-edge
- E18.** eased-edge

Step 3. Depth

36 36" deep

Step 4. Width

For squared-edge (S18.) or thin-edge (T18.)

- 72** 72" wide
- 78** 78" wide
- 84** 84" wide
- 90** 90" wide
- 96** 96" wide

For eased-edge (E18.)

- 72** 72" wide
- 78** 78" wide

Step 5. Surface Material

For squared-edge (S18.) with 72" wide (72) or 78" wide (78)

- L** laminate top/thermoplastic edge
- W** veneer top/veneer edge A
- P** painted Formcoat® top/edge

For thin-edge (T18.) with 72" wide (72) or 78" wide (78)

- L** laminate top/thermoplastic edge
- W** veneer top/veneer edge A
- P** painted Formcoat® top/edge

For eased-edge (E18.) with 72" wide (72) or 78" wide (78)

- P** painted Formcoat® top/edge

For squared-edge (S18.) with 84" wide (84), 90" wide (90), or 96" wide (96)

- L** laminate top/thermoplastic edge
- W** veneer top/veneer edge A

Bowtie Rectangular Surface

continued

For thin-edge (T18.) with 84" wide (84), 90" wide (90), or 96" wide (96)

- L** laminate top/thermoplastic edge
- W** veneer top/veneer edge A

Step 6. Attachment

- S** no brackets, for free standing or use with low credenza

Prices for Steps 1-6.

	LS	WS	PS
FTS18. 36 72	\$839	1443	1025
78	\$949	1580	1092
84	\$966	1625	—
90	\$1022	1709	—
96	\$1077	1792	—
FTT18. 36 72	\$1245	1788	1092
78	\$1313	1898	1162
84	\$1409	2008	—
90	\$1515	2108	—
96	\$1565	2207	—
FTE18. 36 72	—	—	\$1129
78	—	—	\$1202

Step 7.

Top Finish

For laminate top/thermoplastic edge (L)

8Q folkstone grey	+\$0
91 white	+\$0
98 studio white	+\$0
CL cool grey neutral	+\$0
HF inner tone light A	+\$0
HT inner tone A	+\$0
LU soft white	+\$0
WL sandstone	+\$0
WN warm grey neutral	+\$0
76 light brown walnut	+\$0
HM natural maple	+\$0
HP light anigre	+\$0
HX aged cherry	+\$0
HY walnut on cherry	+\$0
LA light ash A	+\$0
LBA clear on ash	+\$0
LBR phantom ecru	+\$0
LBS phantom cocoa	+\$0
LBU medium matte walnut	+\$0

LBV warm grey teak	+\$0
LBB oak on ash	+\$0
LBC walnut on ash	+\$0
LBD dark brown walnut	+\$0
LBE medium red walnut	+\$0
OG honey maple A	+\$0
LBF neutral twill	+\$0
LBG sarum twill	+\$0
LBH earthen twill	+\$0
LBJ graphite twill	+\$0
LBQ white twill	+\$0
LBK pewter mesh	+\$0
LBL steel mesh	+\$0
LBM crisp linen	+\$0
LBN classic linen	+\$0
LBP casual linen	+\$0

Top/Edge Finish: Wood Veneer

For veneer top/veneer edge (W)

2U light brown walnut A	+\$85
40 dark brown walnut A	+\$85
ED aged cherry A	+\$85
EK medium red walnut A	+\$85
EW medium matte walnut A	+\$85
ET clear on ash A	+\$85
EU oak on ash A	+\$85
EV walnut on ash A	+\$85
UL natural maple A	+\$85
UX walnut on cherry A	+\$85

Top/Edge Finish: Opaque Formcoat®

For painted Formcoat® top/edge (P)

8Q folkstone grey	+\$0
91 white	+\$0
CL cool grey neutral	+\$0
LU soft white	+\$0
WL sandstone	+\$0
WN warm grey neutral	+\$0

Step 8. Edge Finish

For laminate top/thermoplastic edge (L)

76 light brown walnut	+\$0
8Q folkstone grey	+\$0
91 white	+\$0
98 studio white	+\$0
CL cool grey neutral	+\$0
LA light ash	+\$0

Bowtie Rectangular Surface

continued

Canvas Office Landscape® Work Surfaces

LBA	clear on ash	+\$0
LBR	phantom ecru	+\$0
LBS	phantom cocoa	+\$0
LBU	medium matte walnut	+\$0
LBV	warm grey teak	+\$0
LBB	oak on ash	+\$0
LBC	walnut on ash	+\$0
LBD	dark brown walnut	+\$0
LBE	medium red walnut	+\$0
LBF	neutral twill	+\$0
LBG	sarum twill	+\$0
LBH	earthen twill	+\$0
LBJ	graphite twill	+\$0
LBK	pewter mesh	+\$0
LBL	steel mesh	+\$0
LBM	crisp linen	+\$0
LBN	classic linen	+\$0
LBP	casual linen	+\$0
LBQ	white twill	+\$0
WL	sandstone	+\$0
WN	warm grey neutral	+\$0
HF	inner tone light	+\$0
HM	natural maple	+\$0
HP	light anigre	+\$0
HT	inner tone	+\$0
HX	aged cherry	+\$0
HY	walnut on cherry	+\$0
LU	soft white	+\$0
OG	honey maple	+\$0

Curvilinear Surface

FTE12.
FTS12.
FTT12.

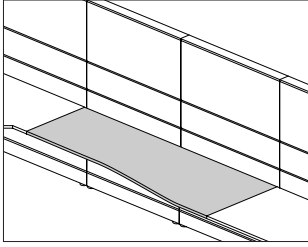

Product Information

Description

This surface hangs from a frame, wall strips, or attaches to various support components to create a freestanding desk. It is 24" deep on 1 side and 30" deep on the other side. The surface has a laminate top and thermoplastic edge, a veneer top and edge, or a painted top and edge. Laminate and veneer surfaces are 1 1/4" thick. Painted Formcoat® surfaces are 1" thick. When hanging from a frame or wall strips, there is a 1" gap at the back of the surface for standard plug head and cord passage.

Notes

For additional size, shape, cable management, and finish options, see Vary Easy Program in Appendices.

For Canvas frame attached surface (F) option:

- Order appropriate supports separately; 2 supports are required for each surface (left and right side):
 - Open support, tapered foot, frame attached (FT294.)
 - Open support, architectural foot, frame attached (FT2A1.)
 - Support panel, tapered foot, frame attached (FT291.)
 - Support panel, frame attached (FT2E2.)
 - Universal post leg, frame attached (FT2B1.)
 - Surface cantilever (FT290.)
 - Surface support rail (FT295.)
 - Support pedestal

- Center supports are included for surfaces 54" wide and wider.

For no brackets, for freestanding or use with low credenza (S) option:

- Order the following support products separately:
 - Closed support leg (FV2E2.)
 - Open support leg, architectural foot (FV2A2.)
 - Square open support leg (FV2D2.)
 - Support leg, post (FV689.)
 - Universal post leg (FT2B2.)
 - Surface support, low credenza, adjustable height (FT299.)
 - Surface support, low credenza, fixed height (FT298.)
 - Surface-attached pedestal
- When creating a freestanding desk with closed support leg (FV2E2.), a modesty panel (FV697.) is required for stability.

Thin-edge surface does not work with the following:

- Surface-attached pedestal
- Support pedestal
- Closed support leg (FV2E2.)
- Square open support leg (FV2D2.)

Stiffener (FV696.) is required for any laminate or veneer surface 54" wide or wider and painted formcoat surfaces 48" wide or wider that cannot use a center cantilever. See Canvas Office Landscape® Planning Guide for specific stiffener guidelines.

Dimensions

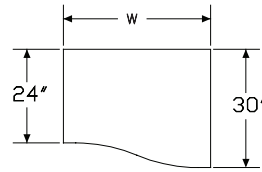

24" Deep Left
30" Deep Right

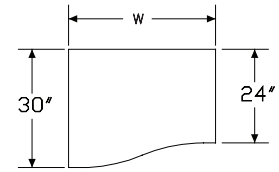

30" Deep Left
24" Deep Right

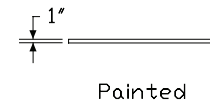
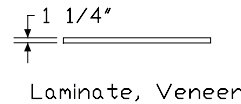

Curvilinear Surface *continued*

Specification Information	
Step 1.	
FT	
Step 2. Edge	
S12.	squared-edge
T12.	thin-edge
E12.	eased-edge
Step 3. Depth	
24	24" deep left, 30" deep right
30	30" deep left, 24" deep right
Step 4. Width	
30	30" wide
36	36" wide
42	42" wide
48	48" wide
54	54" wide
60	60" wide
66	66" wide
72	72" wide
Step 5. Surface Material	
<i>For squared-edge (S12.)</i>	
L	lamine top/thermoplastic edge
W	vener top/vener edge A
P	painted Formcoat® top/edge
<i>For thin-edge (T12.)</i>	
L	lamine top/thermoplastic edge
W	vener top/vener edge A
P	painted Formcoat® top/edge
<i>For eased-edge (E12.)</i>	
P	painted Formcoat® top/edge
Step 6. Attachment	
<i>For 30" wide (30), 36" wide (36), or 42" wide (42)</i>	
F	Canvas frame attached surface
<i>For 48" wide (48), 54" wide (54), 60" wide (60), 66" wide (66), or 72" wide (72)</i>	
F	Canvas frame attached surface
S	no brackets, for free standing or use with low credenza

Prices for Steps 1-6.							
		LF	LS	WF	WS	PF	PS
FTS12.	24 30	\$300	—	657	—	345	—
	36	\$326	—	716	—	375	—
	42	\$377	—	813	—	435	—
	48	\$431	388	917	871	494	452
	54	\$440	397	939	891	506	464
	60	\$447	404	953	905	515	472
	66	\$526	483	1110	1063	605	563
	72	\$600	557	1259	1211	690	648
	30 30	\$300	—	657	—	345	—
	36	\$326	—	716	—	375	—
	42	\$377	—	813	—	435	—
	48	\$431	388	917	871	494	452
	54	\$440	397	939	891	506	464
	60	\$447	404	953	905	515	472
	66	\$526	483	1110	1063	605	563
	72	\$600	557	1259	1211	690	648
FTT12.	24 30	\$418	—	789	—	368	—
	36	\$456	—	857	—	400	—
	42	\$528	—	977	—	463	—
	48	\$602	559	1103	1055	527	484
	54	\$615	573	1126	1079	538	495
	60	\$625	583	1145	1096	548	506
	66	\$735	692	1332	1285	644	601
	72	\$839	797	1510	1462	735	692
	30 30	\$418	—	789	—	368	—
	36	\$456	—	857	—	400	—
	42	\$528	—	977	—	463	—
	48	\$602	559	1103	1055	527	484
	54	\$615	573	1126	1079	538	495
	60	\$625	583	1145	1096	548	506
	66	\$735	692	1332	1285	644	601
	72	\$839	797	1510	1462	735	692
FTE12.	24 30	—	—	—	—	\$381	—
	36	—	—	—	—	\$414	—
	42	—	—	—	—	\$478	—
	48	—	—	—	—	\$544	500
	54	—	—	—	—	\$557	514
	60	—	—	—	—	\$567	523
	66	—	—	—	—	\$666	622
	72	—	—	—	—	\$760	717

Curvilinear Surface *continued*

30	30	—	—	—	—	\$381	—
36		—	—	—	—	\$414	—
42		—	—	—	—	\$478	—
48		—	—	—	—	\$544	500
54		—	—	—	—	\$557	514
60		—	—	—	—	\$567	523
66		—	—	—	—	\$666	622
72		—	—	—	—	\$760	717

Step 7.

Top Finish

For laminate top/thermoplastic edge (L)

8Q	folkstone grey	+\$0
91	white	+\$0
98	studio white	+\$0
CL	cool grey neutral	+\$0
HF	inner tone light	+\$0
HT	inner tone	+\$0
LU	soft white	+\$0
WL	sandstone	+\$0
WN	warm grey neutral	+\$0
76	light brown walnut	+\$0
HM	natural maple	+\$0
HP	light anigre	+\$0
HX	aged cherry	+\$0
HY	walnut on cherry	+\$0
LA	light ash	+\$0
LBA	clear on ash	+\$0
LBR	phantom ecru	+\$0
LBS	phantom cocoa	+\$0
LBU	medium matte walnut	+\$0
LBV	warm grey teak	+\$0
LBB	oak on ash	+\$0
LBC	walnut on ash	+\$0
LBD	dark brown walnut	+\$0
LBE	medium red walnut	+\$0
OG	honey maple	+\$0
LBF	neutral twill	+\$0
LBG	sarum twill	+\$0
LBH	earthen twill	+\$0
LBJ	graphite twill	+\$0
LBQ	white twill	+\$0
LBK	pewter mesh	+\$0
LBL	steel mesh	+\$0
LBM	crisp linen	+\$0
LBN	classic linen	+\$0

LBP	casual linen	+\$0
-----	--------------	------

Top/Edge Finish: Wood Veneer

For veneer top/veneer edge (W)

2U	light brown walnut <input type="checkbox"/> A	+\$85
40	dark brown walnut <input type="checkbox"/> A	+\$85
ED	aged cherry <input type="checkbox"/> A	+\$85
EK	medium red walnut <input type="checkbox"/> A	+\$85
EW	medium matte walnut <input type="checkbox"/> A	+\$85
ET	clear on ash <input type="checkbox"/> A	+\$85
EU	oak on ash <input type="checkbox"/> A	+\$85
EV	walnut on ash <input type="checkbox"/> A	+\$85
UL	natural maple <input type="checkbox"/> A	+\$85
UX	walnut on cherry <input type="checkbox"/> A	+\$85

Top/Edge Finish: Opaque Formcoat®

For painted Formcoat® top/edge (P)

8Q	folkstone grey	+\$0
91	white	+\$0
CL	cool grey neutral	+\$0
LU	soft white	+\$0
WL	sandstone	+\$0
WN	warm grey neutral	+\$0

Step 8. Edge Finish

For laminate top/thermoplastic edge (L)

76	light brown walnut	+\$0
8Q	folkstone grey	+\$0
91	white	+\$0
98	studio white	+\$0
CL	cool grey neutral	+\$0
LA	light ash	+\$0
LBA	clear on ash	+\$0
LBR	phantom ecru	+\$0
LBS	phantom cocoa	+\$0
LBU	medium matte walnut	+\$0
LBV	warm grey teak	+\$0
LBB	oak on ash	+\$0
LBC	walnut on ash	+\$0
LBD	dark brown walnut	+\$0
LBE	medium red walnut	+\$0
LBF	neutral twill	+\$0
LBG	sarum twill	+\$0
LBH	earthen twill	+\$0
LBJ	graphite twill	+\$0
LBK	pewter mesh	+\$0
LBL	steel mesh	+\$0

Curvilinear Surface *continued*

Canvas Office Landscape® Work Surfaces

LBM	crisp linen	+\$0
LBN	classic linen	+\$0
LBP	casual linen	+\$0
LBQ	white twill	+\$0
WL	sandstone	+\$0
WN	warm grey neutral	+\$0
HF	inner tone light	+\$0
HM	natural maple	+\$0
HP	light anigre	+\$0
HT	inner tone	+\$0
HX	aged cherry	+\$0
HY	walnut on cherry	+\$0
LU	soft white	+\$0
OG	honey maple	+\$0

Rectangular Surface, Transition, Single

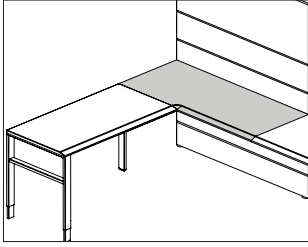

FTE1A.
FTE1B.
FTE1C.
FTE1D.
FTT1A.
FTT1B.
FTT1C.
FTT1D.

Product Information

Description

This surface is available with a partial thin- or eased-edge positioned right or left. This allows another 24"- or 30"-deep thin- or eased-edge frame-attached rectangular surface, curvilinear surface, or surface-attached single rectangular or round end peninsula to be positioned at a right angle creating an L-shaped configuration. Thin-edge surface material has a laminate top and thermoplastic edge, or a veneer top and edge, or a painted top and edge. Eased-edge surface material has a painted top and edge. Laminate and veneer surfaces are 1¹/₄" thick. Painted Formcoat® surfaces are 1" thick. When hanging from a frame or wall strips there is a 1" gap at the back of the surface for standard plug head and cord passage.

Notes

For additional size, shape, cable management, and finish options, see Vary Easy Program in Appendices.

For Canvas frame attached surface (F) option:

- Order appropriate supports separately; 2 supports are required for each surface (left and right side):
 - Open support, tapered foot, frame attached (FT294.)
 - Open support, architectural foot, frame attached (FT2A1.)
 - Support panel, tapered foot, frame attached (FT291.)
 - Support panel, frame attached (FT2E2.)
 - Universal post leg, frame attached (FT2B1.)
 - Surface cantilever (FT290.)
 - Surface support rail (FT295.)
 - Support pedestal

• Center supports are included for surfaces 54" wide and wider.

For no brackets, for freestanding or use with low credenza (S) option:

- Order the following support products separately:
 - Closed support leg (FV2E2.)
 - Open support leg, architectural foot (FV2A2.)
 - Square open support leg (FV2D2.)
 - Support leg, post (FV689.)
 - Universal post leg (FT2B2.)
 - Surface support, low credenza, adjustable height (FT299.)
 - Surface support, low credenza, fixed height (FT298.)
 - Surface-attached pedestal

• When creating a freestanding desk with closed support leg (FV2E2.), a modesty panel (FV697.) is required for stability.

Thin-edge surface does not work with the following:

- Surface-attached pedestal
- Support pedestal
- Closed support leg (FV2E2.)
- Square open support leg (FV2D2.)

Stiffener (FV696.) is required for any laminate or veneer surface 54" wide or wider and painted formcoat surfaces 48" wide or wider that cannot use a center cantilever. See Canvas Office Landscape® Planning Guide for specific stiffener guidelines.

Dimensions

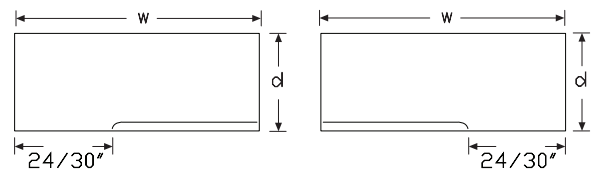

Transition Left

Transition Right

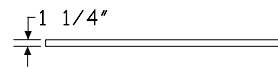

Laminate, Veneer

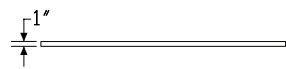

Painted

Rectangular Surface, Transition, Single *continued*

Specification Information

Step 1.

FT

Step 2. Edge

- T1A.** thin-edge right, 24" transition left
- T1B.** thin-edge left, 24" transition right
- T1C.** thin-edge right, 30" transition left
- T1D.** thin-edge left, 30" transition right
- E1A.** eased-edge right, 24" transition left
- E1B.** eased-edge left, 24" transition right
- E1C.** eased-edge right, 30" transition left
- E1D.** eased-edge left, 30" transition right

Step 3. Depth

- 24** 24" deep
- 30** 30" deep

Step 4. Width

- 48** 48" wide
- 54** 54" wide
- 60** 60" wide
- 66** 66" wide
- 72** 72" wide
- 78** 78" wide
- 84** 84" wide
- 90** 90" wide
- 96** 96" wide

Step 5. Surface Material

For thin-edge left, 24" transition right (T1B.)

- L** laminate top/thermoplastic edge
- W** veneer top/veneer edge **A**
- P** painted Formcoat® top/edge

For thin-edge right, 24" transition left (T1A.)

- L** laminate top/thermoplastic edge
- W** veneer top/veneer edge **A**
- P** painted Formcoat® top/edge

For thin-edge right, 30" transition left (T1C.)

- L** laminate top/thermoplastic edge
- W** veneer top/veneer edge **A**
- P** painted Formcoat® top/edge

For thin-edge left, 30" transition right (T1D.)

- L** laminate top/thermoplastic edge
- W** veneer top/veneer edge **A**
- P** painted Formcoat® top/edge

For eased-edge right, 24" transition left (E1A.)

- P** painted Formcoat® top/edge

For eased-edge left, 24" transition right (E1B.)

- P** painted Formcoat® top/edge

For eased-edge right, 30" transition left (E1C.)

- P** painted Formcoat® top/edge

For eased-edge left, 30" transition right (E1D.)

- P** painted Formcoat® top/edge

Step 6. Attachment

- F** Canvas frame attached surface
- S** no brackets, for free standing or use with low credenza

Prices for Steps 1-6.

		LF	LS	WF	WS	PF	PS
FTT1A.	24 48	\$375	332	837	789	478	436
	54	\$436	393	961	914	555	514
	60	\$457	415	997	949	584	541
	66	\$512	469	1107	1060	651	608
	72	\$564	522	1215	1167	720	677
	78	\$616	574	1320	1272	786	743
	84	\$685	643	1453	1405	874	831
	90	\$704	662	1481	1434	899	857
	96	\$734	691	1533	1486	936	893
	30 48	\$451	408	988	941	576	533
	54	\$532	489	1152	1105	679	636
	60	\$590	547	1264	1216	751	709
	66	\$665	622	1424	1376	847	805
	72	\$738	695	1574	1526	941	898
	78	\$789	746	1673	1625	1007	964
	84	\$849	807	1784	1738	1083	1040
	90	\$897	855	1863	1816	1145	1102
	96	\$940	897	1931	1882	1198	1156

Rectangular Surface, Transition,
Single *continued*

FTT1B. 24 48	\$375	332	837	789	478	436
54	\$436	393	961	914	555	514
60	\$457	415	997	949	584	541
66	\$512	469	1107	1060	651	608
72	\$564	522	1215	1167	720	677
78	\$616	574	1320	1272	786	743
84	\$685	643	1453	1405	874	831
90	\$704	662	1481	1434	899	857
96	\$734	691	1533	1486	936	893
30 48	\$451	408	988	941	576	533
54	\$532	489	1152	1105	679	636
60	\$590	547	1264	1216	751	709
66	\$665	622	1424	1376	847	805
72	\$738	695	1574	1526	941	898
78	\$789	746	1673	1625	1007	964
84	\$849	807	1784	1738	1083	1040
90	\$897	855	1863	1816	1145	1102
96	\$940	897	1931	1882	1198	1156
FTT1C. 24 48	\$371	329	829	781	473	432
54	\$432	389	952	905	550	509
60	\$453	411	987	940	578	536
66	\$507	464	1096	1050	645	602
72	\$558	517	1203	1156	713	670
78	\$610	568	1307	1260	778	736
84	\$678	637	1439	1391	865	823
90	\$697	656	1466	1420	890	849
96	\$727	684	1518	1471	927	884
30 48	\$447	404	978	932	570	528
54	\$527	484	1141	1094	672	630
60	\$584	542	1252	1204	744	702
66	\$658	616	1410	1363	839	797
72	\$731	688	1559	1511	932	889
78	\$781	739	1657	1609	997	955
84	\$841	799	1767	1721	1072	1030
90	\$888	847	1845	1798	1134	1091
96	\$931	888	1912	1864	1186	1145
FTT1D. 24 48	\$371	329	829	781	473	432
54	\$432	389	952	905	550	509
60	\$453	411	987	940	578	536
66	\$507	464	1096	1050	645	602
72	\$558	517	1203	1156	713	670
78	\$610	568	1307	1260	778	736
84	\$678	637	1439	1391	865	823
90	\$697	656	1466	1420	890	849
96	\$727	684	1518	1471	927	884

30 48	\$447	404	978	932	570	528
54	\$527	484	1141	1094	672	630
60	\$584	542	1252	1204	744	702
66	\$658	616	1410	1363	839	797
72	\$731	688	1559	1511	932	889
78	\$781	739	1657	1609	997	955
84	\$841	799	1767	1721	1072	1030
90	\$888	847	1845	1798	1134	1091
96	\$931	888	1912	1864	1186	1145
FTE1A. 24 48	—	—	—	—	\$494	450
54	—	—	—	—	\$575	531
60	—	—	—	—	\$604	560
66	—	—	—	—	\$674	630
72	—	—	—	—	\$743	699
78	—	—	—	—	\$812	769
84	—	—	—	—	\$904	860
90	—	—	—	—	\$931	887
96	—	—	—	—	\$967	924
30 48	—	—	—	—	\$596	552
54	—	—	—	—	\$701	657
60	—	—	—	—	\$778	734
66	—	—	—	—	\$876	832
72	—	—	—	—	\$974	930
78	—	—	—	—	\$1041	997
84	—	—	—	—	\$1119	1076
90	—	—	—	—	\$1184	1140
96	—	—	—	—	\$1240	1196
FTE1B. 24 48	—	—	—	—	\$494	450
54	—	—	—	—	\$575	531
60	—	—	—	—	\$604	560
66	—	—	—	—	\$674	630
72	—	—	—	—	\$743	699
78	—	—	—	—	\$812	769
84	—	—	—	—	\$904	860
90	—	—	—	—	\$931	887
96	—	—	—	—	\$967	924
30 48	—	—	—	—	\$596	552
54	—	—	—	—	\$701	657
60	—	—	—	—	\$778	734
66	—	—	—	—	\$876	832
72	—	—	—	—	\$974	930
78	—	—	—	—	\$1041	997
84	—	—	—	—	\$1119	1076
90	—	—	—	—	\$1184	1140
96	—	—	—	—	\$1240	1196

Rectangular Surface, Transition, Single *continued*

Canvas Office Landscape® Work Surfaces

FTE1C.	24	48	—	—	—	—	\$494	450
		54	—	—	—	—	\$575	531
		60	—	—	—	—	\$604	560
		66	—	—	—	—	\$674	630
		72	—	—	—	—	\$743	699
		78	—	—	—	—	\$812	769
		84	—	—	—	—	\$904	860
		90	—	—	—	—	\$931	887
		96	—	—	—	—	\$967	924
	30	48	—	—	—	—	\$596	552
		54	—	—	—	—	\$701	657
		60	—	—	—	—	\$778	734
		66	—	—	—	—	\$876	832
		72	—	—	—	—	\$974	930
		78	—	—	—	—	\$1041	997
		84	—	—	—	—	\$1119	1076
		90	—	—	—	—	\$1184	1140
		96	—	—	—	—	\$1240	1196
FTE1D.	24	48	—	—	—	—	\$489	446
		54	—	—	—	—	\$569	526
		60	—	—	—	—	\$598	555
		66	—	—	—	—	\$667	624
		72	—	—	—	—	\$736	692
		78	—	—	—	—	\$804	761
		84	—	—	—	—	\$895	852
		90	—	—	—	—	\$922	878
		96	—	—	—	—	\$958	915
	30	48	—	—	—	—	\$590	547
		54	—	—	—	—	\$694	651
		60	—	—	—	—	\$770	727
		66	—	—	—	—	\$867	824
		72	—	—	—	—	\$964	921
		78	—	—	—	—	\$1031	987
		84	—	—	—	—	\$1108	1065
		90	—	—	—	—	\$1172	1129
		96	—	—	—	—	\$1228	1184

Step 7.

Top Finish

For laminate top/thermoplastic edge (L)

8Q	folkstone grey	+\$0
91	white	+\$0
98	studio white	+\$0
CL	cool grey neutral	+\$0
HF	inner tone light A	+\$0

HT	inner tone A	+\$0
LU	soft white	+\$0
WL	sandstone	+\$0
WN	warm grey neutral	+\$0
76	light brown walnut	+\$0
HM	natural maple	+\$0
HP	light anigre	+\$0
HX	aged cherry	+\$0
HY	walnut on cherry	+\$0
LA	light ash A	+\$0
LBA	clear on ash	+\$0
LBR	phantom ecru	+\$0
LBS	phantom cocoa	+\$0
LBU	medium matte walnut	+\$0
LBV	warm grey teak	+\$0
LBB	oak on ash	+\$0
LBC	walnut on ash	+\$0
LBD	dark brown walnut	+\$0
LBE	medium red walnut	+\$0
OG	honey maple A	+\$0
LBF	neutral twill	+\$0
LBG	sarum twill	+\$0
LBH	earthen twill	+\$0
LBJ	graphite twill	+\$0
LBQ	white twill	+\$0
LBK	pewter mesh	+\$0
LBL	steel mesh	+\$0
LBM	crisp linen	+\$0
LBN	classic linen	+\$0
LBP	casual linen	+\$0

Top/Edge Finish: Wood Veneer

For veneer top/veneer edge (W)

2U	light brown walnut A	+\$85
40	dark brown walnut A	+\$85
ED	aged cherry A	+\$85
EK	medium red walnut A	+\$85
EW	medium matte walnut A	+\$85
ET	clear on ash A	+\$85
EU	oak on ash A	+\$85
EV	walnut on ash A	+\$85
UL	natural maple A	+\$85
UX	walnut on cherry A	+\$85

Rectangular Surface, Transition, Single *continued*

Top/Edge Finish: Opaque Formcoat®

For painted Formcoat® top/edge (P)

8Q	folkstone grey	+\$0
91	white	+\$0
CL	cool grey neutral	+\$0
LU	soft white	+\$0
WL	sandstone	+\$0
WN	warm grey neutral	+\$0

Step 8. Edge Finish

For laminate top/thermoplastic edge (L)

76	light brown walnut	+\$0
8Q	folkstone grey	+\$0
91	white	+\$0
98	studio white	+\$0
CL	cool grey neutral	+\$0
LA	light ash	+\$0
LBA	clear on ash	+\$0
LBR	phantom ecru	+\$0
LBS	phantom cocoa	+\$0
LBU	medium matte walnut	+\$0
LBV	warm grey teak	+\$0
LBB	oak on ash	+\$0
LBC	walnut on ash	+\$0
LBD	dark brown walnut	+\$0
LBE	medium red walnut	+\$0
LBF	neutral twill	+\$0
LBG	sarum twill	+\$0
LBH	earthen twill	+\$0
LBJ	graphite twill	+\$0
LBK	pewter mesh	+\$0
LBL	steel mesh	+\$0
LBM	crisp linen	+\$0
LBN	classic linen	+\$0
LBP	casual linen	+\$0
LBQ	white twill	+\$0
WL	sandstone	+\$0
WN	warm grey neutral	+\$0
HF	inner tone light	+\$0
HM	natural maple	+\$0
HP	light anigre	+\$0
HT	inner tone	+\$0
HX	aged cherry	+\$0
HY	walnut on cherry	+\$0
LU	soft white	+\$0
OG	honey maple	+\$0

Rectangular Surface, Transition, Double

FTE1H.
FTE1J.
FTE1K.
FTT1H.
FTT1J.
FTT1K.

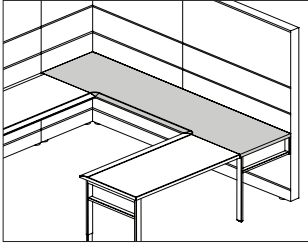

Product Information

Description

This surface is available with a partial thin- or eased-edge positioned at the center. This allows another 24"- or 30"-deep thin- or eased-edge frame-attached rectangular surface, curvilinear surface, or surface-attached single rectangular or round-end peninsula to be positioned on each end creating a U-shaped configuration. Thin-edge surface has a laminate top and thermoplastic edge, or a veneer top and edge, or a painted top and edge. Eased-edge surface has a painted top and edge. Laminate and veneer surfaces are 1 1/4" thick. Painted Formcoat® surfaces are 1" thick. When hanging from a frame or wall strips there is a 1" gap at the back of the surface for standard plug head and cord passage.

Notes

For additional size, shape, cable management, and finish options, see **Vary Easy Program in Appendices.**

For Canvas frame attached surface (F) option:

- Order appropriate supports separately; 2 supports are required for each surface (left and right side):
 - Open support, tapered foot, frame attached (FT294.)
 - Open support, architectural foot, frame attached (FT2A1.)
 - Support panel, tapered foot, frame attached (FT291.)
 - Support panel, frame attached (FT2E2.)
 - Universal post leg, frame attached (FT2B1.)
 - Surface cantilever (FT290.)
 - Surface support rail (FT295.)
- Center supports are included.

For no brackets, for freestanding or use with low credenza (S) option:

- Order the following support products separately:
 - Closed support leg (FV2E2.)
 - Open support leg, architectural foot (FV2A2.)
 - Square open support leg (FV2D2.)
 - Support leg, post (FV689.)
 - Universal post leg (FT2B2.)
- When creating a freestanding desk with closed support leg (FV2E2.), a **modesty panel (FV697.)** is required for stability.

Stiffener (FV696.) is required for any laminate or veneer surface 54" wide or wider and painted formcoat surfaces 48" wide or wider that cannot use a center cantilever. See Canvas Office Landscape® Planning Guide for specific stiffener guidelines.

Dimensions

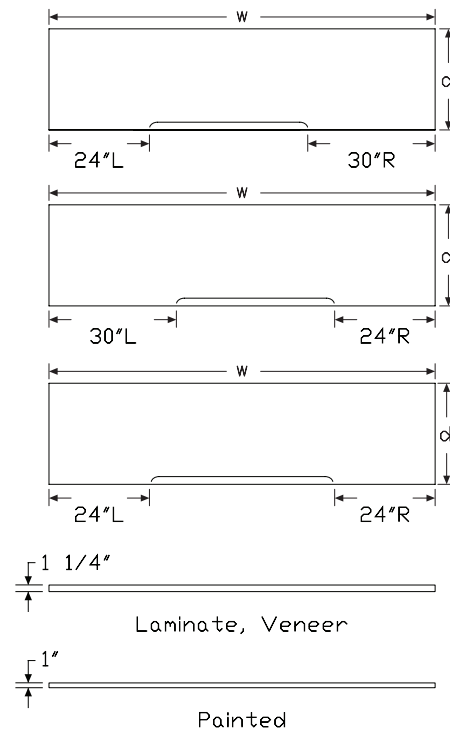

Rectangular Surface, Transition, Double *continued*

Specification Information

Step 1.

FT

Step 2. Edge

- T1H.** thin-edge, 24" transition, left and right
- T1J.** thin-edge, 24" transition on left, 30" on right
- T1K.** thin-edge, 24" transition on right, 30" on left
- E1H.** eased-edge, 24" transition on left and right
- E1J.** eased-edge, 24" transition on left, 30" on right
- E1K.** eased-edge, 24" transition on right, 30" on left

Step 3. Depth

- 24** 24" deep
- 30** 30" deep

Step 4. Width

- 90** 90" wide
- 96** 96" wide

Step 5. Surface Material

For thin-edge, 24" transition, left and right (T1H.)

- L** laminate top/thermoplastic edge
- W** veneer top/veneer edge A
- P** painted Formcoat® top/edge

For thin-edge, 24" transition on left, 30" on right (T1J.)

- L** laminate top/thermoplastic edge
- W** veneer top/veneer edge A
- P** painted Formcoat® top/edge

For thin-edge, 24" transition on right, 30" on left (T1K.)

- L** laminate top/thermoplastic edge
- W** veneer top/veneer edge A
- P** painted Formcoat® top/edge

For eased-edge, 24" transition on left and right (E1H.)

- P** painted Formcoat® top/edge

For eased-edge, 24" transition on left, 30" on right (E1J.)

- P** painted Formcoat® top/edge

For eased-edge, 24" transition on right, 30" on left (E1K.)

- P** painted Formcoat® top/edge

Step 6. Attachment

- F** Canvas frame attached surface
- S** no brackets, for free standing or use with low credenza

Prices for Steps 1-6.

	LF	LS	WF	WS	PF	PS
FTT1H. 24 90	\$697	656	1466	1420	890	849
96	\$727	684	1518	1471	927	884
30 90	\$888	847	1845	1798	1134	1091
96	\$931	888	1912	1864	1186	1145
FTT1J. 24 90	\$697	656	1466	1420	890	849
96	\$727	684	1518	1471	927	884
30 90	\$888	847	1845	1798	1134	1091
96	\$931	888	1912	1864	1186	1145
FTT1K. 24 90	\$697	656	1466	1420	890	849
96	\$727	684	1518	1471	927	884
30 90	\$888	847	1845	1798	1134	1091
96	\$931	888	1912	1864	1186	1145
FTE1H. 24 90	—	—	—	—	\$922	878
96	—	—	—	—	\$958	915
30 90	—	—	—	—	\$1172	1129
96	—	—	—	—	\$1228	1184
FTE1J. 24 90	—	—	—	—	\$922	878
96	—	—	—	—	\$958	915
30 90	—	—	—	—	\$1172	1129
96	—	—	—	—	\$1228	1184
FTE1K. 24 90	—	—	—	—	\$922	878
96	—	—	—	—	\$958	915
30 90	—	—	—	—	\$1172	1129
96	—	—	—	—	\$1228	1184
Step 7.						
Top Finish						
<i>For laminate top/thermoplastic edge (L)</i>						
8Q	folkstone grey					+\$0
91	white					+\$0
98	studio white					+\$0
CL	cool grey neutral					+\$0
HF	inner tone light A					+\$0
HT	inner tone A					+\$0
LU	soft white					+\$0

Rectangular Surface, Transition, Double *continued*

WL	sandstone	+\$0
WN	warm grey neutral	+\$0
76	light brown walnut	+\$0
HM	natural maple	+\$0
HP	light anigre	+\$0
HX	aged cherry	+\$0
HY	walnut on cherry	+\$0
LA	light ash A	+\$0
LBA	clear on ash	+\$0
LBR	phantom ecru	+\$0
LBS	phantom cocoa	+\$0
LBU	medium matte walnut	+\$0
LBV	warm grey teak	+\$0
LBB	oak on ash	+\$0
LBC	walnut on ash	+\$0
LBD	dark brown walnut	+\$0
LBE	medium red walnut	+\$0
OG	honey maple A	+\$0
LBF	neutral twill	+\$0
LBG	sarum twill	+\$0
LBH	earthen twill	+\$0
LBJ	graphite twill	+\$0
LBQ	white twill	+\$0
LBK	pewter mesh	+\$0
LBL	steel mesh	+\$0
LBM	crisp linen	+\$0
LBN	classic linen	+\$0
LBP	casual linen	+\$0

Top/Edge Finish: Wood Veneer
For veneer top/veneer edge (W)

2U	light brown walnut A	+\$85
40	dark brown walnut A	+\$85
ED	aged cherry A	+\$85
EK	medium red walnut A	+\$85
EW	medium matte walnut A	+\$85
ET	clear on ash A	+\$85
EU	oak on ash A	+\$85
EV	walnut on ash A	+\$85
UL	natural maple A	+\$85
UX	walnut on cherry A	+\$85

Top/Edge Finish: Opaque Formcoat®

For painted Formcoat® top/edge (P)

8Q	folkstone grey	+\$0
91	white	+\$0
CL	cool grey neutral	+\$0
LU	soft white	+\$0
WL	sandstone	+\$0
WN	warm grey neutral	+\$0

Step 8. Edge Finish

For laminate top/thermoplastic edge (L)

76	light brown walnut	+\$0
8Q	folkstone grey	+\$0
91	white	+\$0
98	studio white	+\$0
CL	cool grey neutral	+\$0
LA	light ash	+\$0
LBA	clear on ash	+\$0
LBR	phantom ecru	+\$0
LBS	phantom cocoa	+\$0
LBU	medium matte walnut	+\$0
LBV	warm grey teak	+\$0
LBB	oak on ash	+\$0
LBC	walnut on ash	+\$0
LBD	dark brown walnut	+\$0
LBE	medium red walnut	+\$0
LBF	neutral twill	+\$0
LBG	sarum twill	+\$0
LBH	earthen twill	+\$0
LBJ	graphite twill	+\$0
LBK	pewter mesh	+\$0
LBL	steel mesh	+\$0
LBM	crisp linen	+\$0
LBN	classic linen	+\$0
LBP	casual linen	+\$0
LBQ	white twill	+\$0
WL	sandstone	+\$0
WN	warm grey neutral	+\$0
HF	inner tone light	+\$0
HM	natural maple	+\$0
HP	light anigre	+\$0
HT	inner tone	+\$0
HX	aged cherry	+\$0
HY	walnut on cherry	+\$0
LU	soft white	+\$0
OG	honey maple	+\$0

Rectangular Surface, Transition, Center

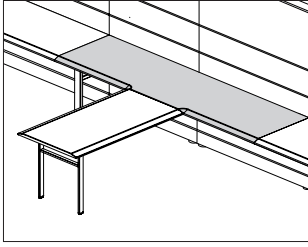

FTE1E.
FTE1F.
FTE1G.
FTT1E.
FTT1F.
FTT1G.

Product Information

Description

This surface is available with a partial thin- or eased-edge positioned on the left and right. This allows attachment of a thin- or eased-edge center rectangular or round-end peninsula at the center. Thin-edge surface has a laminate top and thermoplastic edge, or a veneer top and edge, or a painted top and edge. Eased-edge surface has a painted top and edge. Laminate and veneer surfaces are 1/4" thick. Painted Formcoat® surfaces are 1" thick. When hanging from a frame or wall strips there is a 1" gap at the back of the surface for standard plug head and cord passage.

Notes

For additional size, shape, cable management, and finish options, see Vary Easy Program in Appendices.

For Canvas frame attached surface (F) option:

- Order appropriate supports separately; 2 supports are required for each surface (left and right side):
 - Open support, tapered foot, frame attached (FT294.)
 - Open support, architectural foot, frame attached (FT2A1.)
 - Support panel, tapered foot, frame attached (FT291.)
 - Support panel, frame attached (FT2E2.)
 - Universal post leg, frame attached (FT2B1.)
 - Surface cantilever (FT290.)
 - Surface support rail (FT295.)

• Center supports are included.

For no brackets, for freestanding or use with low credenza (S) option:

- Order the following support products separately:
 - Closed support leg (FV2E2.)
 - Open support leg, architectural foot (FV2A2.)
 - Square open support leg (FV2D2.)
 - Support leg, post (FV689.)
 - Universal post leg (FT2B2.)
 - Surface-attached pedestal

• When creating a freestanding desk with closed support leg (FV2E2.), a modesty panel (FV697.) is required for stability.

Thin-edge surface does not work with the following:

- Surface-attached pedestal
- Support pedestal
- Closed support leg (FV2E2.)
- Square open support leg (FV2D2.)

Stiffener (FV696.) is required for any laminate or veneer surface 54" wide or wider and painted formcoat surfaces 48" wide or wider that cannot use a center cantilever. See Canvas Office Landscape® Planning Guide for specific stiffener guidelines.

Dimensions

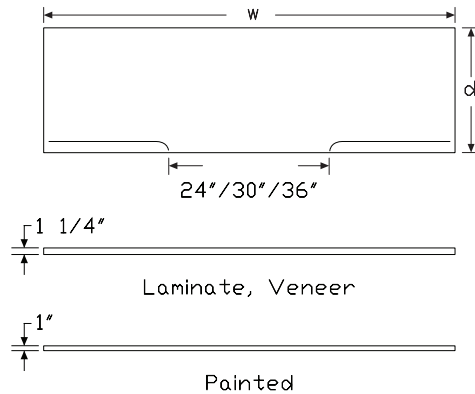

Rectangular Surface, Transition, Center *continued*

Specification Information	
Step 1.	
FT	
Step 2. Edge	
T1E.	thin-edge, 24" center attached peninsula
T1F.	thin-edge, 30" center attached peninsula
T1G.	thin-edge, 36" center attached peninsula
E1E.	eased-edge, 24" center attached peninsula
E1F.	eased-edge, 30" center attached peninsula
E1G.	eased-edge, 36" center attached peninsula
Step 3. Depth	
24	24" deep
30	30" deep
Step 4. Width	
84	84" wide
90	90" wide
96	96" wide
Step 5. Surface Material	
<i>For thin-edge, 24" center attached peninsula (T1E.)</i>	
L	lamine top/thermoplastic edge
W	vener top/vener edge A
P	painted Formcoat® top/edge
<i>For thin-edge, 30" center attached peninsula (T1F.)</i>	
L	lamine top/thermoplastic edge
W	vener top/vener edge A
P	painted Formcoat® top/edge
<i>For thin-edge, 36" center attached peninsula (T1G.)</i>	
L	lamine top/thermoplastic edge
W	vener top/vener edge A
P	painted Formcoat® top/edge
<i>For eased-edge, 24" center attached peninsula (E1E.)</i>	
P	painted Formcoat® top/edge
<i>For eased-edge, 30" center attached peninsula (E1F.)</i>	
P	painted Formcoat® top/edge
<i>For eased-edge, 36" center attached peninsula (E1G.)</i>	
P	painted Formcoat® top/edge

Step 6. Attachment							
F	Canvas frame attached surface						
S	no brackets, for free standing or use with low credenza						
Prices for Steps 1-6.							
		LF	LS	WF	WS	PF	PS
FTT1E.	24 84	\$678	637	1439	1391	865	823
	90	\$697	656	1466	1420	890	849
	96	\$727	684	1518	1471	927	884
30 84	84	\$841	799	1767	1721	1072	1030
	90	\$888	847	1845	1798	1134	1091
	96	\$931	888	1912	1864	1186	1145
FTT1F.	24 84	\$678	637	1439	1391	865	823
	90	\$697	656	1466	1420	890	849
	96	\$727	684	1518	1471	927	884
30 84	84	\$841	799	1767	1721	1072	1030
	90	\$888	847	1845	1798	1134	1091
	96	\$931	888	1912	1864	1186	1145
FTT1G.	24 84	\$678	637	1439	1391	865	823
	90	\$697	656	1466	1420	890	849
	96	\$727	684	1518	1471	927	884
30 84	84	\$841	799	1767	1721	1072	1030
	90	\$888	847	1845	1798	1134	1091
	96	\$931	888	1912	1864	1186	1145
FTE1E.	24 84	—	—	—	—	\$895	852
	90	—	—	—	—	\$922	878
	96	—	—	—	—	\$958	915
30 84	84	—	—	—	—	\$1108	1065
	90	—	—	—	—	\$1172	1129
	96	—	—	—	—	\$1228	1184
FTE1F.	24 84	—	—	—	—	\$904	860
	90	—	—	—	—	\$931	887
	96	—	—	—	—	\$967	924
30 84	84	—	—	—	—	\$1119	1076
	90	—	—	—	—	\$1184	1140
	96	—	—	—	—	\$1240	1196
FTE1G.	24 84	—	—	—	—	\$895	852
	90	—	—	—	—	\$922	878
	96	—	—	—	—	\$958	915
30 84	84	—	—	—	—	\$1108	1065
	90	—	—	—	—	\$1172	1129
	96	—	—	—	—	\$1228	1184

Rectangular Surface, Transition, Center *continued*

Step 7.

Top Finish

For laminate top/thermoplastic edge (L)

8Q	folkstone grey	+\$0
91	white	+\$0
98	studio white	+\$0
CL	cool grey neutral	+\$0
HF	inner tone light A	+\$0
HT	inner tone A	+\$0
LU	soft white	+\$0
WL	sandstone	+\$0
WN	warm grey neutral	+\$0
76	light brown walnut	+\$0
HM	natural maple	+\$0
HP	light anigre	+\$0
HX	aged cherry	+\$0
HY	walnut on cherry	+\$0
LA	light ash A	+\$0
LBA	clear on ash	+\$0
LBR	phantom ecru	+\$0
LBS	phantom cocoa	+\$0
LBU	medium matte walnut	+\$0
LBV	warm grey teak	+\$0
LBB	oak on ash	+\$0
LBC	walnut on ash	+\$0
LBD	dark brown walnut	+\$0
LBE	medium red walnut	+\$0
OG	honey maple A	+\$0
LBF	neutral twill	+\$0
LBG	sarum twill	+\$0
LBH	earthen twill	+\$0
LBJ	graphite twill	+\$0
LBQ	white twill	+\$0
LBK	pewter mesh	+\$0
LBL	steel mesh	+\$0
LBM	crisp linen	+\$0
LBN	classic linen	+\$0
LBP	casual linen	+\$0

Top/Edge Finish: Wood Veneer

For veneer top/veneer edge (W)

2U	light brown walnut A	+\$85
40	dark brown walnut A	+\$85
ED	aged cherry A	+\$85
EK	medium red walnut A	+\$85
EW	medium matte walnut A	+\$85
ET	clear on ash A	+\$85
EU	oak on ash A	+\$85
EV	walnut on ash A	+\$85
UL	natural maple A	+\$85
UX	walnut on cherry A	+\$85

Top/Edge Finish: Opaque Formcoat®

For painted Formcoat® top/edge (P)

8Q	folkstone grey	+\$0
91	white	+\$0
CL	cool grey neutral	+\$0
LU	soft white	+\$0
WL	sandstone	+\$0
WN	warm grey neutral	+\$0

Step 8. Edge Finish

For laminate top/thermoplastic edge (L)

76	light brown walnut	+\$0
8Q	folkstone grey	+\$0
91	white	+\$0
98	studio white	+\$0
CL	cool grey neutral	+\$0
LA	light ash	+\$0
LBA	clear on ash	+\$0
LBR	phantom ecru	+\$0
LBS	phantom cocoa	+\$0
LBU	medium matte walnut	+\$0
LBV	warm grey teak	+\$0
LBB	oak on ash	+\$0
LBC	walnut on ash	+\$0
LBD	dark brown walnut	+\$0
LBE	medium red walnut	+\$0
LBF	neutral twill	+\$0
LBG	sarum twill	+\$0
LBH	earthen twill	+\$0
LBJ	graphite twill	+\$0
LBK	pewter mesh	+\$0
LBL	steel mesh	+\$0
LBM	crisp linen	+\$0
LBN	classic linen	+\$0

Rectangular Surface, Transition,
Center *continued*

Canvas Office Landscape® Work Surfaces

LBP	casual linen	+\$0
LBQ	white twill	+\$0
WL	sandstone	+\$0
WN	warm grey neutral	+\$0
HF	inner tone light	+\$0
HM	natural maple	+\$0
HP	light anigre	+\$0
HT	inner tone	+\$0
HX	aged cherry	+\$0
HY	walnut on cherry	+\$0
LU	soft white	+\$0
OG	honey maple	+\$0

Corner Surface

FTE20.
FTS20.
FTT20.

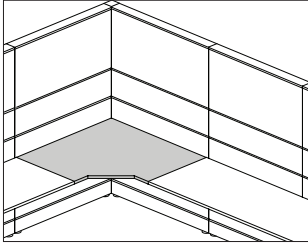

Product Information

Description

This 90° corner surface hangs from frames, wall strips or attaches to support components and adjacent surfaces to create a freestanding corner desk. It has a laminate top and thermoplastic edge, laminate top with a thermoplastic backed plywood edge, veneer top and edge, or painted top and edge. Laminate and veneer surfaces are 1¹/₄" thick. Painted Formcoat® surfaces are 1" thick. When hanging from frames or wall strips there is a 1" gap at the back of the surface for standard plug head and cord passage.

Notes

For additional size, shape, cable management, and finish options, see Vary Easy Program in Appendices.

For Canvas frame attached surface (F) option:

- Order appropriate supports separately; 2 supports are required for each surface (left and right side):
 - Open support, tapered foot, frame attached (FT294.)
 - Open support, architectural foot, frame attached (FT2A1.)
 - Support panel, tapered foot, frame attached (FT291.)
 - Support panel, frame attached (FT2E2.)
 - Surface cantilever (FT290.)

- A corner support bracket is included.

For no brackets, for freestanding or use with low credenza (S) option:

- Surface must be connected to adjacent surfaces on both sides and surfaces must be the same depth.
- A back corner support and 2 end supports are required for each surface (left and right side):
- To support the back corner of the surface, order one of the following separately:
 - Support leg, post (FV689.)
 - Universal post leg (FT2B2.)
- To support the ends, order two of the following separately:
 - Closed support leg (FV2E2.), shared position
 - Square open support leg (FV2D2.), shared position
 - Open support leg, architectural foot (FV2A2.), shared position

Dimensions

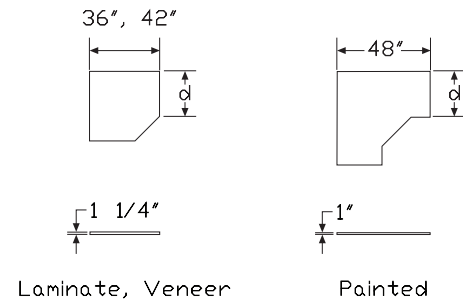

Laminate, Veneer

Painted

Specification Information

Step 1.

FT

Step 2. Edge

S20. squared-edge

T20. thin-edge

E20. eased-edge

Step 3. Depth

24 24" deep

30 30" deep

Step 4. Width

For 24" deep (24)

36 36" wide

42 42" wide

48 48" wide

For 30" deep (30)

42 42" wide

48 48" wide

Step 5. Surface Material

For squared-edge (S20.)

L laminate top/thermoplastic edge

W veneer top/veneer edge **A**

P painted Formcoat® top/edge

For thin-edge (T20.)

L laminate top/thermoplastic edge

W veneer top/veneer edge **A**

P painted Formcoat® top/edge

For eased-edge (E20.)

P painted Formcoat® top/edge

Step 6. Attachment

F Canvas frame attached surface

S for freestanding applications

Prices for Steps 1-6.

	LF	LS	WF	WS	PF	PS
FTS20. 24 36	\$342	298	738	691	393	349
42	\$415	371	878	830	478	434
48	\$488	444	1009	961	561	518
30 42	\$520	476	1075	1028	598	554
48	\$582	538	1191	1142	670	626
FTT20. 24 36	\$478	434	887	840	418	374
42	\$581	537	1053	1006	510	467
48	\$682	638	1211	1163	598	554
30 42	\$728	684	1289	1242	637	593
48	\$813	770	1428	1381	713	669
FTE20. 24 36	—	—	—	—	\$418	374
42	—	—	—	—	\$510	467
48	—	—	—	—	\$598	554
30 42	—	—	—	—	\$637	593
48	—	—	—	—	\$713	669

Step 7.

Top Finish

For laminate top/thermoplastic edge (L)

8Q	folkstone grey	+\$0
91	white	+\$0
98	studio white	+\$0
CL	cool grey neutral	+\$0
HF	inner tone light A	+\$0
HT	inner tone A	+\$0
LU	soft white	+\$0
WL	sandstone	+\$0
WN	warm grey neutral	+\$0
76	light brown walnut	+\$0
HM	natural maple	+\$0
HP	light anigre	+\$0
HX	aged cherry	+\$0
HY	walnut on cherry	+\$0
LA	light ash A	+\$0
LBA	clear on ash	+\$0
LBR	phantom ecru	+\$0
LBS	phantom cocoa	+\$0
LBU	medium matte walnut	+\$0
LBV	warm grey teak	+\$0
LBB	oak on ash	+\$0
LBC	walnut on ash	+\$0
LBD	dark brown walnut	+\$0

Corner Surface *continued*

LBE	medium red walnut	+\$0
OG	honey maple <input type="checkbox"/> A	+\$0
LBF	neutral twill	+\$0
LBG	sarum twill	+\$0
LBH	earthen twill	+\$0
LBJ	graphite twill	+\$0
LBQ	white twill	+\$0
LBK	pewter mesh	+\$0
LBL	steel mesh	+\$0
LBM	crisp linen	+\$0
LBN	classic linen	+\$0
LBP	casual linen	+\$0

Top/Edge Finish: Wood Veneer

For veneer top/veneer edge (W)

2U	light brown walnut <input type="checkbox"/> A	+\$110
40	dark brown walnut <input type="checkbox"/> A	+\$110
ED	aged cherry <input type="checkbox"/> A	+\$110
EK	medium red walnut <input type="checkbox"/> A	+\$110
EW	medium matte walnut <input type="checkbox"/> A	+\$110
ET	clear on ash <input type="checkbox"/> A	+\$110
EU	oak on ash <input type="checkbox"/> A	+\$110
EV	walnut on ash <input type="checkbox"/> A	+\$110
UL	natural maple <input type="checkbox"/> A	+\$110
UX	walnut on cherry <input type="checkbox"/> A	+\$110

Top/Edge Finish: Opaque Formcoat®

For painted Formcoat® top/edge (P)

8Q	folkstone grey	+\$0
91	white	+\$0
CL	cool grey neutral	+\$0
LU	soft white	+\$0
WL	sandstone	+\$0
WN	warm grey neutral	+\$0

Step 8. Edge Finish

For laminate top/thermoplastic edge (L)

76	light brown walnut	+\$0
8Q	folkstone grey	+\$0
91	white	+\$0
98	studio white	+\$0
CL	cool grey neutral	+\$0
LA	light ash	+\$0
LBA	clear on ash	+\$0
LBR	phantom ecru	+\$0
LBS	phantom cocoa	+\$0
LBU	medium matte walnut	+\$0

LBV	warm grey teak	+\$0
LBB	oak on ash	+\$0
LBC	walnut on ash	+\$0
LBD	dark brown walnut	+\$0
LBE	medium red walnut	+\$0
LBF	neutral twill	+\$0
LBG	sarum twill	+\$0
LBH	earthen twill	+\$0
LBJ	graphite twill	+\$0
LBK	pewter mesh	+\$0
LBL	steel mesh	+\$0
LBM	crisp linen	+\$0
LBN	classic linen	+\$0
LBP	casual linen	+\$0
LBQ	white twill	+\$0
WL	sandstone	+\$0
WN	warm grey neutral	+\$0
HF	inner tone light	+\$0
HM	natural maple	+\$0
HP	light anigre	+\$0
HT	inner tone	+\$0
HX	aged cherry	+\$0
HY	walnut on cherry	+\$0
LU	soft white	+\$0
OG	honey maple	+\$0

Concave Corner Surface

FTE21.

FTS21.

FTT21.

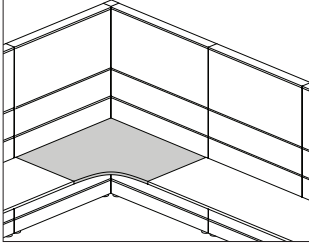

Product Information

Description

This 90° corner surface hangs from frames, wall strips, or attaches to support components and adjacent surfaces to create a freestanding corner desk. It has a laminate top and thermoplastic edge, a veneer top and edge, or a painted top and edge. Laminate and veneer surfaces are 1 1/4" thick. Painted Formcoat® surfaces are 1" thick. When hanging from frames or wall strips there is a 1" gap at the back of the surface for standard plug head and cord passage.

Notes

For additional size, shape, cable management, and finish options, see [Vary Easy Program in Appendices](#).

For Canvas frame attached surface (F) option:

- Order appropriate supports separately; 2 supports are required for each surface (left and right side):
 - Open support, tapered foot, frame attached (FT294.)
 - Open support, architectural foot, frame attached (FT2A1.)
 - Support panel, tapered foot, frame attached (FT291.)
 - Support panel, frame attached (FT2E2.)
 - Surface cantilever (FT290.)

- A corner support bracket is included.

For no brackets, for freestanding or use with low credenza (S) option:

- Surface must be connected to adjacent surfaces on both sides and surfaces must be the same depth.
- A back corner support and 2 end supports are required for each surface (left and right side):
 - To support the back corner of the surface, order one of the following separately:
 - Support leg, post (FV689.)
 - Universal post leg (FT2B2.)
 - To support the ends, order two of the following separately:
 - Closed support leg (FV2E2.), shared position
 - Square open support leg (FV2D2.), shared position
 - Open support leg, architectural foot (FV2A2.), shared position

Dimensions

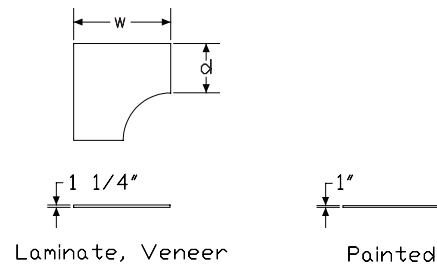

Concave Corner Surface *continued*

Specification Information

Step 1.

FT

Step 2. Edge

S21. squared-edge

T21. thin-edge

E21. eased-edge

Step 3. Depth

24 24" deep

30 30" deep

Step 4. Width

For 24" deep (24)

36 36" wide

42 42" wide

48 48" wide

For 30" deep (30)

42 42" wide

48 48" wide

Step 5. Surface Material

For squared-edge (S21.)

L laminate top/thermoplastic edge

W veneer top/veneer edge **A**

P painted Formcoat® top/edge

For thin-edge (T21.)

L laminate top/thermoplastic edge

W veneer top/veneer edge **A**

P painted Formcoat® top/edge

For eased-edge (E21.)

P painted Formcoat® top/edge

Step 6. Attachment

F Canvas frame attached surface

S for freestanding applications

Prices for Steps 1-6.

		LF	LS	WF	WS	PF	PS
FTS21.	24 36	\$342	298	738	691	393	349
	42	\$415	371	878	830	478	434
	48	\$488	444	1009	961	561	518
	30 42	\$520	476	1075	1028	598	554
	48	\$582	538	1191	1142	670	626
FTT21.	24 36	\$478	434	887	840	418	374
	42	\$581	537	1053	1006	510	467
	48	\$682	638	1211	1163	598	554
	30 42	\$728	690	1289	1242	637	593
	48	\$813	770	1428	1381	713	669
FTE21.	24 36	—	—	—	—	\$418	374
	42	—	—	—	—	\$510	467
	48	—	—	—	—	\$598	554
	30 42	—	—	—	—	\$637	593
	48	—	—	—	—	\$713	669

Step 7.

Top Finish

For laminate top/thermoplastic edge (L)

8Q	folkstone grey	+\$0
91	white	+\$0
98	studio white	+\$0
CL	cool grey neutral	+\$0
HF	inner tone light A	+\$0
HT	inner tone A	+\$0
LU	soft white	+\$0
WL	sandstone	+\$0
WN	warm grey neutral	+\$0
76	light brown walnut	+\$0
HM	natural maple	+\$0
HP	light anigre	+\$0
HX	aged cherry	+\$0
HY	walnut on cherry	+\$0
LA	light ash A	+\$0
LBA	clear on ash	+\$0
LBR	phantom ecru	+\$0
LBS	phantom cocoa	+\$0
LBU	medium matte walnut	+\$0
LBV	warm grey teak	+\$0
LBB	oak on ash	+\$0
LBC	walnut on ash	+\$0
LBD	dark brown walnut	+\$0

Concave Corner Surface *continued*

LBE	medium red walnut	+\$0
OG	honey maple <input type="checkbox"/> A	+\$0
LBF	neutral twill	+\$0
LBG	sarum twill	+\$0
LBH	earthen twill	+\$0
LBJ	graphite twill	+\$0
LBQ	white twill	+\$0
LBK	pewter mesh	+\$0
LBL	steel mesh	+\$0
LBM	crisp linen	+\$0
LBN	classic linen	+\$0
LBP	casual linen	+\$0

Top/Edge Finish: Wood Veneer

For veneer top/veneer edge (W)

2U	light brown walnut <input type="checkbox"/> A	+\$110
40	dark brown walnut <input type="checkbox"/> A	+\$110
ED	aged cherry <input type="checkbox"/> A	+\$110
EK	medium red walnut <input type="checkbox"/> A	+\$110
EW	medium matte walnut <input type="checkbox"/> A	+\$110
ET	clear on ash <input type="checkbox"/> A	+\$110
EU	oak on ash <input type="checkbox"/> A	+\$110
EV	walnut on ash <input type="checkbox"/> A	+\$110
UL	natural maple <input type="checkbox"/> A	+\$110
UX	walnut on cherry <input type="checkbox"/> A	+\$110

Top/Edge Finish: Opaque Formcoat®

For painted Formcoat® top/edge (P)

8Q	folkstone grey	+\$0
91	white	+\$0
CL	cool grey neutral	+\$0
LU	soft white	+\$0
WL	sandstone	+\$0
WN	warm grey neutral	+\$0

Step 8. Edge Finish

For laminate top/thermoplastic edge (L)

76	light brown walnut	+\$0
8Q	folkstone grey	+\$0
91	white	+\$0
98	studio white	+\$0
CL	cool grey neutral	+\$0
LA	light ash	+\$0
LBA	clear on ash	+\$0
LBR	phantom ecru	+\$0
LBS	phantom cocoa	+\$0
LBU	medium matte walnut	+\$0

LBV	warm grey teak	+\$0
LBB	oak on ash	+\$0
LBC	walnut on ash	+\$0
LBD	dark brown walnut	+\$0
LBE	medium red walnut	+\$0
LBF	neutral twill	+\$0
LBG	sarum twill	+\$0
LBH	earthen twill	+\$0
LBJ	graphite twill	+\$0
LBK	pewter mesh	+\$0
LBL	steel mesh	+\$0
LBM	crisp linen	+\$0
LBN	classic linen	+\$0
LBP	casual linen	+\$0
LBQ	white twill	+\$0
WL	sandstone	+\$0
WN	warm grey neutral	+\$0
HF	inner tone light	+\$0
HM	natural maple	+\$0
HP	light anigre	+\$0
HT	inner tone	+\$0
HX	aged cherry	+\$0
HY	walnut on cherry	+\$0
LU	soft white	+\$0
OG	honey maple	+\$0

Corner Surface with Input Platform Cutout

FTS24.

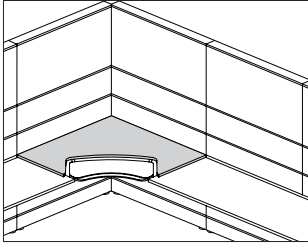

Product Information

Description

This 90°, 24"-deep corner surface hangs from frames or wall strips and is used with adjacent 24"-deep squared-edge surfaces. It has a 1¼"-thick laminate top with thermoplastic edge, and a cutout for a user-adjustable input platform. There is a 1" gap at the back of the surface for standard plug head and cord passage. A corner support bracket is included.

Notes

For additional size, shape, cable management, and finish options, see Vary Easy Program in Appendices.

Order 2 surface cantilevers (FT290.) separately.

Order Flex-Edge™ input platform (Y7735.) separately.

Storage products cannot mount under work surface.

Dimensions

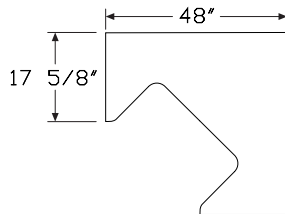

Specification Information

Step 1.

FT

Step 2. Edge

S24. squared-edge

Step 3. Depth

24 24" deep

Step 4. Width

48 48" wide

Step 5. Surface Material

L laminate top/thermoplastic edge

Step 6. Attachment

F Canvas frame attached surface

Prices for Steps 1-6.

	LF
FTS24. 24 48	\$572

Step 7. Top Finish

8Q	folkstone grey	+ \$0
91	white	+ \$0
98	studio white	+ \$0
CL	cool grey neutral	+ \$0
HF	inner tone light A	+ \$0
HT	inner tone A	+ \$0
LU	soft white	+ \$0
WL	sandstone	+ \$0
WN	warm grey neutral	+ \$0
76	light brown walnut	+ \$0
HM	natural maple	+ \$0
HP	light anigre	+ \$0
HX	aged cherry	+ \$0
HY	walnut on cherry	+ \$0
LA	light ash A	+ \$0
LBA	clear on ash	+ \$0
LBR	phantom ecru	+ \$0
LBS	phantom cocoa	+ \$0
LBU	medium matte walnut	+ \$0
LBV	warm grey teak	+ \$0
LBB	oak on ash	+ \$0
LBC	walnut on ash	+ \$0
LBD	dark brown walnut	+ \$0

Corner Surface with Input Platform Cutout *continued*

Canvas Office Landscape® Work Surfaces

LBE	medium red walnut	+\$0
OG	honey maple A	+\$0
LBF	neutral twill	+\$0
LBG	sarum twill	+\$0
LBH	earthen twill	+\$0
LBJ	graphite twill	+\$0
LBQ	white twill	+\$0
LBK	pewter mesh	+\$0
LBL	steel mesh	+\$0
LBM	crisp linen	+\$0
LBN	classic linen	+\$0
LBP	casual linen	+\$0

LU	soft white	+\$0
OG	honey maple	+\$0

Step 8. Edge Finish

76	light brown walnut	+\$0
8Q	folkstone grey	+\$0
91	white	+\$0
98	studio white	+\$0
CL	cool grey neutral	+\$0
LA	light ash	+\$0
LBA	clear on ash	+\$0
LBR	phantom ecru	+\$0
LBS	phantom cocoa	+\$0
LBU	medium matte walnut	+\$0
LBV	warm grey teak	+\$0
LBB	oak on ash	+\$0
LBC	walnut on ash	+\$0
LBD	dark brown walnut	+\$0
LBE	medium red walnut	+\$0
LBF	neutral twill	+\$0
LBG	sarum twill	+\$0
LBH	earthen twill	+\$0
LBJ	graphite twill	+\$0
LBK	pewter mesh	+\$0
LBL	steel mesh	+\$0
LBM	crisp linen	+\$0
LBN	classic linen	+\$0
LBP	casual linen	+\$0
LBQ	white twill	+\$0
WL	sandstone	+\$0
WN	warm grey neutral	+\$0
HF	inner tone light	+\$0
HM	natural maple	+\$0
HP	light anigre	+\$0
HT	inner tone	+\$0
HX	aged cherry	+\$0
HY	walnut on cherry	+\$0

Extended Corner Surface, Rectangular End

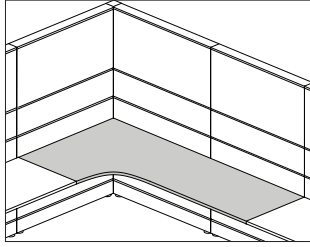

FTE22.
FTE23.
FTS22.
FTS23.
FTT22.
FTT23.

Product Information

Description

This 90° extended corner surface hangs from frames, wall strips, or attaches to support components and adjacent surfaces to create a freestanding extended corner desk. It has a laminate top and thermoplastic edge, a veneer top and edge, or a painted top and edge. Laminate and veneer surfaces are 1/4" thick. Painted Formcoat® surfaces are 1" thick. When hanging from frames or wall strips there is a 1" gap at the back of the surface for standard plug head and cord passage.

Notes

For additional size, shape, cable management, and finish options, see [Vary Easy Program in Appendices](#).

For Canvas frame attached surface (F) option:

- Order appropriate supports separately; 2 supports are required for each surface (left and right side):
 - Open support, tapered foot, frame attached (FT294.)
 - Open support, architectural foot, frame attached (FT2A1.)
 - Support panel, tapered foot, frame attached (FT291.)
 - Support panel, frame attached (FT2E2.)
 - Surface cantilever (FT290.)
 - Support pedestal
- A corner support bracket and center support for the extended side of the surface are included.

For no brackets, for freestanding or use with low credenza (S) option:

- Surface must be connected to adjacent surface on the short end and adjacent surface must be the same depth.
- A back corner support and 2 end supports are required for each surface (left and right side).

For no brackets, for freestanding or use with low credenza (S) option:

- To support the back corner of the surface, order one of the following separately
 - Support leg, post (FV689.)
 - Universal post leg (FT2B2.)
- To support the extended end of the surface, order one of the following separately:
 - Closed support leg (FV2E2.)
 - Open support leg, architectural foot (FV2A2.)
 - Square open support leg (FV2D2.)
 - Support leg, post (FV689.)
 - Universal post leg (FT2B2.)
 - Surface support, low credenza, adjustable height (FT299.)
 - Surface support, low credenza, fixed height (FT298.)
 - Surface-attached pedestal
- To support the short end of the surface, order one of the following separately:
 - Closed support leg (FV2E2.), shared position
 - Open support leg, architectural foot (FV2A2.), shared position
 - Square open support leg (FV2D2.), shared position

Thin-edge surface does not work with the following:

- Support pedestal
- Surface-attached pedestal
- Closed support leg (FV2E2.)
- Square open support leg (FV2D2.)

Stiffener (FV696.) is required for any laminate or veneer surface 54" wide or wider and painted formcoat surfaces 48" wide or wider that cannot use a center cantilever. See Canvas Office Landscape® Planning Guide for specific stiffener guidelines.

Dimensions

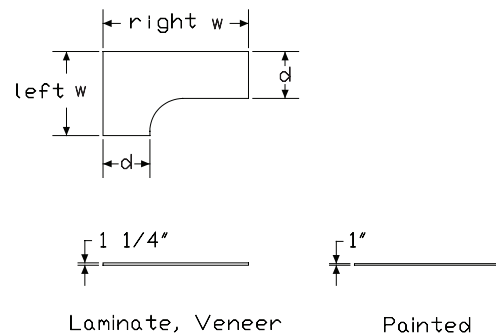

Extended Corner Surface, Rectangular End *continued*

Specification Information

Step 1.

FT

Step 2. Edge

- S22.** squared-edge, 24" deep
- T22.** thin-edge, 24" deep
- E22.** eased-edge, 24" deep
- S23.** squared-edge, 30" deep
- T23.** thin-edge, 30" deep
- E23.** eased-edge, 30" deep

Step 3. Width

For squared-edge, 24" deep (S22.), thin-edge, 24" deep (T22.), or eased-edge, 24" deep (E22.)

- 4260** 42" wide left x 60" wide right
- 4266** 42" wide left x 66" wide right
- 4272** 42" wide left x 72" wide right
- 4278** 42" wide left x 78" wide right
- 4860** 48" wide left x 60" wide right
- 4866** 48" wide left x 66" wide right
- 4872** 48" wide left x 72" wide right
- 4878** 48" wide left x 78" wide right
- 6042** 60" wide left x 42" wide right
- 6048** 60" wide left x 48" wide right
- 6642** 66" wide left x 42" wide right
- 6648** 66" wide left x 48" wide right
- 7242** 72" wide left x 42" wide right
- 7248** 72" wide left x 48" wide right
- 7842** 78" wide left x 42" wide right
- 7848** 78" wide left x 48" wide right

For squared-edge, 30" deep (S23.), thin-edge, 30" deep (T23.), or eased-edge, 30" deep (E23.)

- 4860** 48" wide left x 60" wide right
- 4866** 48" wide left x 66" wide right
- 4872** 48" wide left x 72" wide right
- 4878** 48" wide left x 78" wide right
- 6048** 60" wide left x 48" wide right
- 6648** 66" wide left x 48" wide right
- 7248** 72" wide left x 48" wide right
- 7848** 78" wide left x 48" wide right

Step 4. Surface Material

For squared-edge, 24" deep (S22.)

- L** laminate top/thermoplastic edge
- W** veneer top/veneer edge **A**
- P** painted Formcoat® top/edge

For squared-edge, 30" deep (S23.)

- L** laminate top/thermoplastic edge
- W** veneer top/veneer edge **A**
- P** painted Formcoat® top/edge

For thin-edge, 24" deep (T22.)

- L** laminate top/thermoplastic edge
- W** veneer top/veneer edge **A**
- P** painted Formcoat® top/edge

For thin-edge, 30" deep (T23.)

- L** laminate top/thermoplastic edge
- W** veneer top/veneer edge **A**
- P** painted Formcoat® top/edge

For eased-edge, 24" deep (E22.)

- P** painted Formcoat® top/edge

For eased-edge, 30" deep (E23.)

- P** painted Formcoat® top/edge

Step 5. Attachment

- F** Canvas frame attached surface
- S** for freestanding applications

Prices for Steps 1-5.

	F	S
FTS22. 4260 L	\$747	704
W	\$1576	1529
P	\$860	818
4266 L	\$792	749
W	\$1664	1616
P	\$910	869
4272 L	\$837	795
W	\$1753	1705
P	\$964	923
4278 L	\$883	840
W	\$1839	1792
P	\$1015	973

Extended Corner Surface,
Rectangular End *continued*

Canvas Office Landscape® Work Surfaces

4872 P	\$1116	1073
4878 P	\$1175	1130
6042 P	\$947	903
6048 P	\$1002	958
6642 P	\$1002	958
6648 P	\$1061	1017
7242 P	\$1061	1017
7248 P	\$1116	1073
7842 P	\$1116	1073
7848 P	\$1175	1130

	F	S
FTS23. 4860 L	\$886	843
W	\$1850	1802
P	\$952	909

4866 L	\$932	889
W	\$1938	1892
P	\$1006	962

4872 L	\$976	934
W	\$2026	1979
P	\$1056	1014

4878 L	\$1022	979
W	\$2114	2067
P	\$1107	1065

6048 L	\$886	843
W	\$1850	1802
P	\$952	909

6648 L	\$932	889
W	\$1938	1892
P	\$1006	962

7248 L	\$976	934
W	\$2026	1979
P	\$1056	1014

7848 L	\$1022	979
W	\$2114	2067
P	\$1107	1065

	F	S
FTT23. 4860 L	\$1240	1197
W	\$2219	2171
P	\$1085	1042

4866 L	\$1304	1261
W	\$2325	2278
P	\$1142	1099

4872 L	\$1366	1323
W	\$2431	2383
P	\$1195	1153

4878 L	\$1431	1388
W	\$2537	2489
P	\$1251	1209
6048 L	\$1240	1197
W	\$2219	2171
P	\$1085	1042
6648 L	\$1304	1261
W	\$2325	2278
P	\$1142	1099
7248 L	\$1366	1323
W	\$2431	2383
P	\$1195	1153
7848 L	\$1431	1388
W	\$2537	2489
P	\$1251	1209

	F	S
FTE23. 4860 P	\$1050	1006
4866 P	\$1107	1063
4872 P	\$1163	1119
4878 P	\$1220	1177
6048 P	\$1050	1006
6648 P	\$1107	1063
7248 P	\$1163	1119
7848 P	\$1220	1177

Extended Corner Surface, Rectangular End *continued*

Step 6.

Top Finish

For laminate top/thermoplastic edge (L)

8Q	folkstone grey	+\$0
91	white	+\$0
98	studio white	+\$0
CL	cool grey neutral	+\$0
HF	inner tone light A	+\$0
HT	inner tone A	+\$0
LU	soft white	+\$0
WL	sandstone	+\$0
76	light brown walnut	+\$0
HM	natural maple	+\$0
HP	light anigre	+\$0
HX	aged cherry	+\$0
HY	walnut on cherry	+\$0
LA	light ash A	+\$0
LBA	clear on ash	+\$0
LBR	phantom ecru	+\$0
LBS	phantom cocoa	+\$0
LBU	medium matte walnut	+\$0
LBV	warm grey teak	+\$0
LBB	oak on ash	+\$0
LBC	walnut on ash	+\$0
LBD	dark brown walnut	+\$0
LBE	medium red walnut	+\$0
OG	honey maple A	+\$0
LBF	neutral twill	+\$0
LBG	sarum twill	+\$0
LBH	earthen twill	+\$0
LBJ	graphite twill	+\$0
LBQ	white twill	+\$0
LBK	pewter mesh	+\$0
LBL	steel mesh	+\$0
LBM	crisp linen	+\$0
LBN	classic linen	+\$0
LBP	casual linen	+\$0

Top/Edge Finish: Wood Veneer

For veneer top/veneer edge (W)

2U	light brown walnut A	+\$125
40	dark brown walnut A	+\$125
ED	aged cherry A	+\$125
EK	medium red walnut A	+\$125
EW	medium matte walnut A	+\$125
ET	clear on ash A	+\$125
EU	oak on ash A	+\$125
EV	walnut on ash A	+\$125
UL	natural maple A	+\$125
UX	walnut on cherry A	+\$125

Top/Edge Finish: Opaque Formcoat®

For painted Formcoat® top/edge (P)

8Q	folkstone grey	+\$0
91	white	+\$0
CL	cool grey neutral	+\$0
LU	soft white	+\$0
WL	sandstone	+\$0
WN	warm grey neutral	+\$0

Step 7. Edge Finish

For laminate top/thermoplastic edge (L)

76	light brown walnut	+\$0
8Q	folkstone grey	+\$0
91	white	+\$0
98	studio white	+\$0
CL	cool grey neutral	+\$0
LA	light ash	+\$0
LBA	clear on ash	+\$0
LBR	phantom ecru	+\$0
LBS	phantom cocoa	+\$0
LBU	medium matte walnut	+\$0
LBV	warm grey teak	+\$0
LBB	oak on ash	+\$0
LBC	walnut on ash	+\$0
LBD	dark brown walnut	+\$0
LBE	medium red walnut	+\$0
LBF	neutral twill	+\$0
LBG	sarum twill	+\$0
LBH	earthen twill	+\$0
LBJ	graphite twill	+\$0
LBK	pewter mesh	+\$0
LBL	steel mesh	+\$0
LBM	crisp linen	+\$0
LBN	classic linen	+\$0

Extended Corner Surface,
Rectangular End *continued*

Canvas Office Landscape® Work Surfaces

LBP	casual linen	+\$0
LBQ	white twill	+\$0
WL	sandstone	+\$0
WN	warm grey neutral	+\$0
HF	inner tone light	+\$0
HM	natural maple	+\$0
HP	light anigre	+\$0
HT	inner tone	+\$0
HX	aged cherry	+\$0
HY	walnut on cherry	+\$0
LU	soft white	+\$0
OG	honey maple	+\$0

Extended Corner Surface, Round End

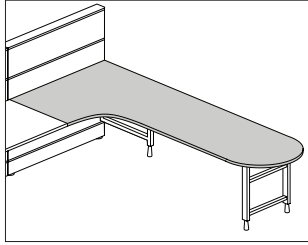

FTE26.
FTE27.
FTS26.
FTS27.
FTT26.
FTT27.

Product Information

Description

This 90° extended corner surface hangs from frames, wall strips, or attaches to support components and adjacent surfaces to create a freestanding extended corner desk. It has a left- or right-hand extension with a round end. It has a laminate top and thermoplastic edge, a veneer top and edge, or a painted top and edge. Laminate and veneer surfaces are 1¹/₄" thick. Painted Formcoat® surfaces are 1" thick. When hanging from frames or wall strips there is a 1" gap at the back of the surface for standard plug head and cord passage.

Notes

For additional size, shape, cable management, and finish options, see Vary Easy Program in Appendices.

Surface requires support at both ends of the surface.

For Canvas frame attached surface (F) option:

- 2 supports are required for each surface (left and right side).
- To support the extended end of the surface when frame attached, specify frame width combination 12" shorter than width of surface and order one of the following separately:
 - Open support, tapered foot, frame attached (FT294.)
 - Open support, architectural foot, frame attached (FT2A1.)
 - Support panel, tapered foot, frame attached (FT291.)
 - Support panel, frame attached (FT2E2.)
- To support the extended end of the surface when used as a peninsula, order one of the following separately:
 - Open support leg, tapered foot, peninsula/d-shaped surface attached (FT2F2.), square edge only
 - Open support leg, architectural foot, peninsula/d-shaped surface attached (FT2A2.A) inset leg position.
 - Square open support leg, peninsula attached (FV2D1.)
 - Support leg, post (FV689.)
 - Universal support leg, post (FT2B2.)

For Canvas frame attached surface (F) option:

- To support the short end of the surface, order one of the following separately:
 - Surface cantilever (FT290.)
 - Open support, tapered foot, frame attached (FT294.)
 - Open support, architectural foot, frame attached (FT2A1.)
 - Support panel, tapered foot, frame attached (FT291.)
 - Support panel, frame attached (FT2E2.)
- A corner support bracket and center support for the extended side of the surface are included.

For no brackets, for freestanding or use with low credenza (S) option:

- Surface must be connected to adjacent surface on the short end and adjacent surface must be the same depth.
- A back corner support and 2 end supports are required for each surface (left and right side).

For no brackets, for freestanding or use with low credenza (S) option:

- To support the back corner of the surface, order one of the following separately:
 - Support leg, post (FV689.)
 - Universal post leg (FT2B2.)
 - To support the extended end of the surface, order one of the following separately:
 - Open support leg, tapered foot, peninsula/D-shaped surface attached (FT2F2.), square edge only
 - Open support leg, architectural foot, peninsula/D-shaped surface attached (FT2A2.)
 - Square open support leg, peninsula attached (FV2D1.)
 - Support leg, post (FV689.)
 - Universal post leg (FT2B2.)
 - To support the short end of the surface, order one of the following separately:
 - Closed support leg (FV2E2.), shared position
 - Open support leg, architectural foot (FV2A2.), shared position
 - Square open support leg (FV2D2.), shared position
- Surface must be connected to adjacent surface on short end and adjacent surface must be the same depth.

Stiffener (FV696.) is required for any laminate or veneer surface 54" wide or wider and painted formcoat surfaces 48" wide or wider that cannot use a center cantilever. See Canvas Office Landscape® Planning Guide for specific stiffener guidelines.

Extended Corner Surface, Round End *continued*

Dimensions

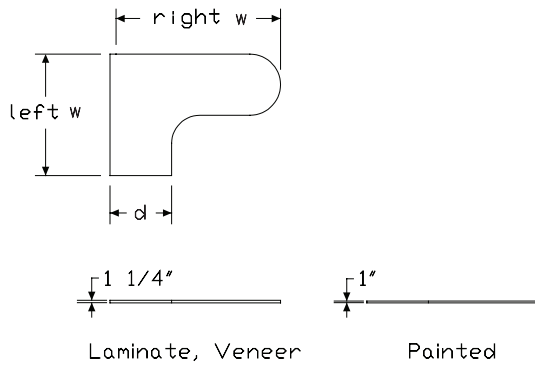

Specification Information

Step 1.

FT

Step 2. Edge

- S26.** squared-edge, 24" deep
- T26.** thin-edge, 24" deep
- E26.** eased-edge, 24" deep
- S27.** squared-edge, 30" deep
- T27.** thin-edge, 30" deep
- E27.** eased-edge, 30" deep

Step 3. Width

- 4866** 48" wide left x 66" wide right
- 4872** 48" wide left x 72" wide right
- 4878** 48" wide left x 78" wide right
- 6648** 66" wide left x 48" wide right
- 7248** 72" wide left x 48" wide right
- 7848** 78" wide left x 48" wide right

Step 4. Surface Material

For squared-edge, 24" deep (S26.)

- L** laminate top/thermoplastic edge
- W** veneer top/veneer edge **A**
- P** painted Formcoat® top/edge

For squared-edge, 30" deep (S27.)

- L** laminate top/thermoplastic edge
- W** veneer top/veneer edge **A**
- P** painted Formcoat® top/edge

For thin-edge, 24" deep (T26.)

- L** laminate top/thermoplastic edge
- W** veneer top/veneer edge **A**
- P** painted Formcoat® top/edge

For thin-edge, 30" deep (T27.)

- L** laminate top/thermoplastic edge
- W** veneer top/veneer edge **A**
- P** painted Formcoat® top/edge

For eased-edge, 24" deep (E26.)

- P** painted Formcoat® top/edge

For eased-edge, 30" deep (E27.)

- P** painted Formcoat® top/edge

Extended Corner Surface, Round
End *continued*

Step 5. Attachment	
F	Canvas frame attached surface
S	for freestanding applications

Prices for Steps 1-5.

	F	S
FTS26. 4866 L	\$737	694
W	\$1472	1424
P	\$847	805
4872 L	\$773	731
W	\$1541	1493
P	\$890	847
4878 L	\$835	793
W	\$1660	1613
P	\$960	917
6648 L	\$737	694
W	\$1472	1424
P	\$847	805
7248 L	\$773	731
W	\$1541	1493
P	\$890	847
7848 L	\$835	793
W	\$1660	1613
P	\$960	917
	F	S
FTT26. 4866 L	\$1021	979
W	\$1750	1702
P	\$893	852
4872 L	\$1071	1029
W	\$1832	1784
P	\$938	895
4878 L	\$1157	1116
W	\$1973	1927
P	\$1014	971
6648 L	\$1021	979
W	\$1750	1702
P	\$893	852
7248 L	\$1071	1029
W	\$1832	1784
P	\$938	895
7848 L	\$1157	1116
W	\$1973	1927
P	\$1014	971
	F	S
FTE26. 4866 P	\$934	890

4872 P	\$980	936
4878 P	\$1059	1015
6648 P	\$934	890
7248 P	\$980	936
7848 P	\$1059	1015

	F	S
FTS27. 4866 L	\$772	730
W	\$1575	1527
P	\$888	845
4872 L	\$809	767
W	\$1645	1598
P	\$932	889
4878 L	\$872	829
W	\$1767	1719
P	\$1002	959
6648 L	\$772	730
W	\$1575	1527
P	\$888	845
7248 L	\$809	767
W	\$1645	1598
P	\$932	889
7848 L	\$872	829
W	\$1767	1719
P	\$1002	959

	F	S
FTT27. 4866 L	\$1069	1028
W	\$1873	1826
P	\$937	894
4872 L	\$1121	1080
W	\$1956	1908
P	\$981	940
4878 L	\$1207	1166
W	\$2098	2052
P	\$1057	1015
6648 L	\$1069	1028
W	\$1873	1826
P	\$937	894
7248 L	\$1121	1080
W	\$1956	1908
P	\$981	940
7848 L	\$1207	1166
W	\$2098	2052
P	\$1057	1015

Extended Corner Surface, Round End *continued*

	F	S
FTE27. 4866 P	\$969	926
4872 P	\$1016	972
4878 P	\$1093	1051
6648 P	\$969	926
7248 P	\$1016	972
7848 P	\$1093	1051

Step 6.

Top Finish

For laminate top/thermoplastic edge (L)

8Q	folkstone grey	+\$0
91	white	+\$0
98	studio white	+\$0
CL	cool grey neutral	+\$0
HF	inner tone light A	+\$0
HT	inner tone A	+\$0
LU	soft white	+\$0
WL	sandstone	+\$0
WN	warm grey neutral	+\$0
76	light brown walnut	+\$0
HM	natural maple	+\$0
HP	light anigre	+\$0
HX	aged cherry	+\$0
HY	walnut on cherry	+\$0
LA	light ash A	+\$0
LBA	clear on ash	+\$0
LBR	phantom ecru	+\$0
LBS	phantom cocoa	+\$0
LBU	medium matte walnut	+\$0
LBV	warm grey teak	+\$0
LBB	oak on ash	+\$0
LBC	walnut on ash	+\$0
LBD	dark brown walnut	+\$0
LBE	medium red walnut	+\$0
OG	honey maple A	+\$0
LBF	neutral twill	+\$0
LBG	sarum twill	+\$0
LBH	earthen twill	+\$0
LBJ	graphite twill	+\$0
LBQ	white twill	+\$0
LBK	pewter mesh	+\$0
LBL	steel mesh	+\$0
LBM	crisp linen	+\$0
LBN	classic linen	+\$0
LBP	casual linen	+\$0

Top/Edge Finish: Wood Veneer

For veneer top/veneer edge (W)

2U	light brown walnut A	+\$125
40	dark brown walnut A	+\$125
ED	aged cherry A	+\$125
EK	medium red walnut A	+\$125
EW	medium matte walnut A	+\$125
ET	clear on ash A	+\$125
EU	oak on ash A	+\$125
EV	walnut on ash A	+\$125
UL	natural maple A	+\$125
UX	walnut on cherry A	+\$125

Top/Edge Finish: Opaque Formcoat®

For painted Formcoat® top/edge (P)

8Q	folkstone grey	+\$0
91	white	+\$0
CL	cool grey neutral	+\$0
LU	soft white	+\$0
WL	sandstone	+\$0
WN	warm grey neutral	+\$0

Step 7. Edge Finish

For laminate top/thermoplastic edge (L)

76	light brown walnut	+\$0
8Q	folkstone grey	+\$0
91	white	+\$0
98	studio white	+\$0
CL	cool grey neutral	+\$0
LA	light ash	+\$0
LBA	clear on ash	+\$0
LBR	phantom ecru	+\$0
LBS	phantom cocoa	+\$0
LBU	medium matte walnut	+\$0
LBV	warm grey teak	+\$0
LBB	oak on ash	+\$0
LBC	walnut on ash	+\$0
LBD	dark brown walnut	+\$0
LBE	medium red walnut	+\$0
LBF	neutral twill	+\$0
LBG	sarum twill	+\$0
LBH	earthen twill	+\$0
LBJ	graphite twill	+\$0
LBK	pewter mesh	+\$0
LBL	steel mesh	+\$0
LBM	crisp linen	+\$0
LBN	classic linen	+\$0

Extended Corner Surface, Round
End *continued*

LBP	casual linen	+\$0
LBQ	white twill	+\$0
WL	sandstone	+\$0
WN	warm grey neutral	+\$0
HF	inner tone light	+\$0
HM	natural maple	+\$0
HP	light anigre	+\$0
HT	inner tone	+\$0
HX	aged cherry	+\$0
HY	walnut on cherry	+\$0
LU	soft white	+\$0
OG	honey maple	+\$0

120° Corner Surface, 90° Ends

FTE40.
FTS40.
FTT40.

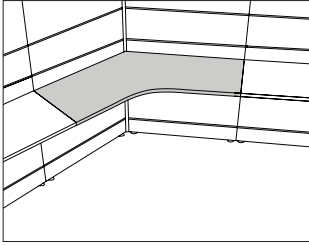

Product Information

Description

This 24"-deep, 120° corner surface hangs from frames and has 90° ends. It has a laminate top and thermoplastic edge, a veneer top and edge, or a painted top and edge. Laminate and veneer surfaces are 1¼" thick. Painted Formcoat® surfaces are 1" thick. There is a 1" gap at the back of the surface for standard plug head and cord passage.

Notes

For additional size, shape, cable management, and finish options, see **Vary Easy Program in Appendices.**

Order appropriate supports separately; 2 supports are required for each surface (left and right side):

- Open support, tapered foot, frame attached (FT294.)
- Open support, architectural foot, frame attached (FT2A1.)
- Support panel, tapered foot, frame attached (FT291.)
- Support panel, frame attached (FT2E2.)
- Surface cantilever (FT290.)

A corner support bracket is included. Center supports are included for 60"-wide surfaces.

Dimensions

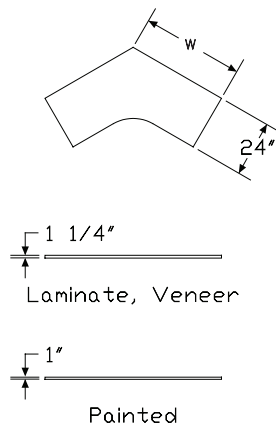

Specification Information

Step 1.

FT

Step 2. Edge

- S40.** squared-edge
T40. thin-edge
E40. eased-edge

Step 3. Depth

24 24" deep

Step 4. Width

- 24** 24" wide
30 30" wide
36 36" wide
42 42" wide
48 48" wide
60 60" wide

Step 5. Surface Material

For squared-edge (S40.) with 24" wide (24), 30" wide (30), 36" wide (36), 42" wide (42), or 48" wide (48)

- L** laminate top/thermoplastic edge
W veneer top/veneer edge **A**
P painted Formcoat® top/edge

For thin-edge (T40.) with 24" wide (24), 30" wide (30), 36" wide (36), 42" wide (42), or 48" wide (48)

- L** laminate top/thermoplastic edge
W veneer top/veneer edge **A**
P painted Formcoat® top/edge

For eased-edge (E40.)

- P** painted Formcoat® top/edge

For squared-edge (S40.) with 60" wide (60)

- L** laminate top/thermoplastic edge
P painted Formcoat® top/edge

For thin-edge (T40.) with 60" wide (60)

- L** laminate top/thermoplastic edge
P painted Formcoat® top/edge

Step 6. Attachment

- F** Canvas frame attached surface

120° Corner Surface, 90° Ends

continued

Prices for Steps 1-6.

	LF	WF	PF
FTS40. 24 24	\$466	1098	535
30	\$584	1354	673
36	\$684	1566	785
42	\$735	1679	846
48	\$784	1782	903
60	\$896	—	1031
FTT40. 24 24	\$650	1317	569
30	\$816	1624	716
36	\$956	1879	839
42	\$1029	2015	900
48	\$1097	2138	960
60	\$1254	—	1098
FTE40. 24 24	—	—	\$569
30	—	—	\$716
36	—	—	\$839
42	—	—	\$900
48	—	—	\$960
60	—	—	\$1098

Step 7.

Top Finish

For laminate top/thermoplastic edge (L)

8Q	folkstone grey	+\$0
91	white	+\$0
98	studio white	+\$0
CL	cool grey neutral	+\$0
HF	inner tone light A	+\$0
HT	inner tone A	+\$0
LU	soft white	+\$0
WL	sandstone	+\$0
WN	warm grey neutral	+\$0
76	light brown walnut	+\$0
HM	natural maple	+\$0
HP	light anigre	+\$0
HX	aged cherry	+\$0
HY	walnut on cherry	+\$0
LA	light ash A	+\$0
LBA	clear on ash	+\$0
LBR	phantom ecru	+\$0
LBS	phantom cocoa	+\$0
LBU	medium matte walnut	+\$0
LBV	warm grey teak	+\$0

LBB	oak on ash	+\$0
LBC	walnut on ash	+\$0
LBD	dark brown walnut	+\$0
LBE	medium red walnut	+\$0
OG	honey maple A	+\$0
LBF	neutral twill	+\$0
LBG	sarum twill	+\$0
LBH	earthen twill	+\$0
LBJ	graphite twill	+\$0
LBQ	white twill	+\$0
LBK	pewter mesh	+\$0
LBL	steel mesh	+\$0
LBM	crisp linen	+\$0
LBN	classic linen	+\$0
LBP	casual linen	+\$0

Top/Edge Finish: Wood Veneer

For veneer top/veneer edge (W)

2U	light brown walnut	+\$110
40	dark brown walnut	+\$110
ED	aged cherry	+\$110
EK	medium red walnut	+\$110
EW	medium matte walnut	+\$110
ET	clear on ash A	+\$110
EU	oak on ash A	+\$110
EV	walnut on ash A	+\$110
UL	natural maple	+\$110
UX	walnut on cherry	+\$110

Top/Edge Finish: Opaque Formcoat®

For painted Formcoat® top/edge (P)

8Q	folkstone grey	+\$0
91	white	+\$0
CL	cool grey neutral	+\$0
LU	soft white	+\$0
WL	sandstone	+\$0
WN	warm grey neutral	+\$0

Step 8. Edge Finish

For laminate top/thermoplastic edge (L)

76	light brown walnut	+\$0
8Q	folkstone grey	+\$0
91	white	+\$0
98	studio white	+\$0
CL	cool grey neutral	+\$0
LA	light ash	+\$0
LBA	clear on ash	+\$0

120° Corner Surface, 90° Ends

continued

Canvas Office Landscape® Work Surfaces

LBR	phantom ecru	+\$0
LBS	phantom cocoa	+\$0
LBU	medium matte walnut	+\$0
LBV	warm grey teak	+\$0
LBB	oak on ash	+\$0
LBC	walnut on ash	+\$0
LBD	dark brown walnut	+\$0
LBE	medium red walnut	+\$0
LBF	neutral twill	+\$0
LBG	sarum twill	+\$0
LBH	earthen twill	+\$0
LBJ	graphite twill	+\$0
LBK	pewter mesh	+\$0
LBL	steel mesh	+\$0
LBM	crisp linen	+\$0
LBN	classic linen	+\$0
LBP	casual linen	+\$0
LBQ	white twill	+\$0
WL	sandstone	+\$0
WN	warm grey neutral	+\$0
HF	inner tone light	+\$0
HM	natural maple	+\$0
HP	light anigre	+\$0
HT	inner tone	+\$0
HX	aged cherry	+\$0
HY	walnut on cherry	+\$0
LU	soft white	+\$0
OG	honey maple	+\$0

120° Corner Surface, 120° Ends

FTE41.
FTS41.
FTT41.

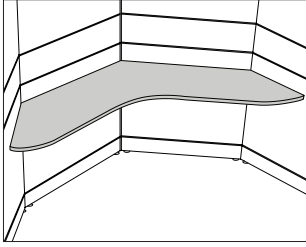

Product Information

Description

This 24"-deep, 120° corner surface hangs from frames and has 120° ends. The ends fit against 2 return frames connected by 120° connectors and form a 120° workstation angle. It has a laminate top and thermoplastic edge, a veneer top and edge, or a painted top and edge. Laminate and veneer surfaces are 1/4" thick. Painted Formcoat® surfaces are 1" thick. There is a 1" gap at the back of the surface for standard plug head and cord passage.

Notes

For additional size, shape, cable management, and finish options, see Vary Easy Program in Appendices.

Order appropriate supports separately; 2 supports are required for each surface (left and right side):

- Open support, tapered foot, frame attached (FT294.)
- Open support, architectural foot, frame attached (FT2A1.)
- Support panel, tapered foot, frame attached (FT291.)
- Support panel, frame attached (FT2E2.)
- Surface cantilever (FT290.)

A corner support bracket is included. Center supports are included for 60"-wide surfaces.

Dimensions

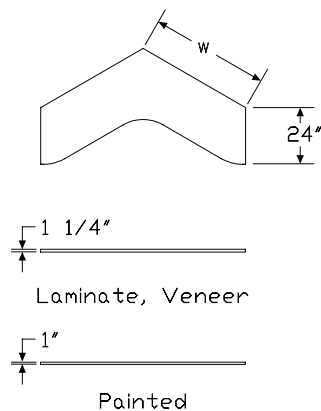

Specification Information

Step 1.

FT

Step 2. Edge

- S41.** squared-edge
- T41.** thin-edge
- E41.** eased-edge

Step 3. Depth

24 24" deep

Step 4. Width

- 36** 36" wide
- 42** 42" wide
- 48** 48" wide
- 60** 60" wide

Step 5. Surface Material

For squared-edge (S41.) with 36" wide (36), 42" wide (42), or 48" wide (48)

- L** laminate top/thermoplastic edge
- W** veneer top/veneer edge **A**
- P** painted Formcoat® top/edge

For thin-edge (T41.) with 36" wide (36), 42" wide (42), or 48" wide (48)

- L** laminate top/thermoplastic edge
- W** veneer top/veneer edge **A**
- P** painted Formcoat® top/edge

For eased-edge (E41.)

- P** painted Formcoat® top/edge

For squared-edge (S41.) with 60" wide (60)

- L** laminate top/thermoplastic edge
- P** painted Formcoat® top/edge

For thin-edge (T41.) with 60" wide (60)

- L** laminate top/thermoplastic edge
- P** painted Formcoat® top/edge

Step 6. Attachment

- F** Canvas frame attached surface

120° Corner Surface, 120° Ends

continued

Canvas Office Landscape® Work Surfaces

Prices for Steps 1-6.

	LF	WF	PF
FTS41. 24 36	\$857	1802	986
42	\$920	1928	1059
48	\$983	2049	1130
60	\$1120	—	1289
FTT41. 24 36	\$1187	2142	1040
42	\$1274	2292	1117
48	\$1361	2434	1192
60	\$1553	—	1360
FTE41. 24 36	—	—	\$1050
42	—	—	\$1128
48	—	—	\$1204
60	—	—	\$1373

Step 7.

Top Finish

For laminate top/thermoplastic edge (L)

8Q	folkstone grey	+\$0
91	white	+\$0
98	studio white	+\$0
CL	cool grey neutral	+\$0
HF	inner tone light A	+\$0
HT	inner tone A	+\$0
LU	soft white	+\$0
WL	sandstone	+\$0
WN	warm grey neutral	+\$0
76	light brown walnut	+\$0
HM	natural maple	+\$0
HP	light anigre	+\$0
HX	aged cherry	+\$0
HY	walnut on cherry	+\$0
LA	light ash A	+\$0
LBA	clear on ash	+\$0
LBR	phantom ecru	+\$0
LBS	phantom cocoa	+\$0
LBU	medium matte walnut	+\$0
LBV	warm grey teak	+\$0
LBB	oak on ash	+\$0
LBC	walnut on ash	+\$0
LBD	dark brown walnut	+\$0
LBE	medium red walnut	+\$0
OG	honey maple A	+\$0
LBF	neutral twill	+\$0

LBG	sarum twill	+\$0
LBH	earthen twill	+\$0
LBJ	graphite twill	+\$0
LBQ	white twill	+\$0
LBK	pewter mesh	+\$0
LBL	steel mesh	+\$0
LBM	crisp linen	+\$0
LBN	classic linen	+\$0
LBP	casual linen	+\$0

Top/Edge Finish: Wood Veneer

For veneer top/veneer edge (W)

2U	light brown walnut	+\$110
40	dark brown walnut	+\$110
ED	aged cherry	+\$110
EK	medium red walnut	+\$110
EW	medium matte walnut	+\$110
ET	clear on ash A	+\$110
EU	oak on ash A	+\$110
EV	walnut on ash A	+\$110
UL	natural maple	+\$110
UX	walnut on cherry	+\$110

Top/Edge Finish: Opaque Formcoat®

For painted Formcoat® top/edge (P)

8Q	folkstone grey	+\$0
91	white	+\$0
CL	cool grey neutral	+\$0
LU	soft white	+\$0
WL	sandstone	+\$0
WN	warm grey neutral	+\$0

Step 8. Edge Finish

For laminate top/thermoplastic edge (L)

76	light brown walnut	+\$0
8Q	folkstone grey	+\$0
91	white	+\$0
98	studio white	+\$0
CL	cool grey neutral	+\$0
LA	light ash	+\$0
LBA	clear on ash	+\$0
LBR	phantom ecru	+\$0
LBS	phantom cocoa	+\$0
LBU	medium matte walnut	+\$0
LBV	warm grey teak	+\$0
LBB	oak on ash	+\$0
LBC	walnut on ash	+\$0

120° Corner Surface, 120° Ends

continued

LBD	dark brown walnut	+\$0
LBE	medium red walnut	+\$0
LBF	neutral twill	+\$0
LBG	sarum twill	+\$0
LBH	earthen twill	+\$0
LBJ	graphite twill	+\$0
LBK	pewter mesh	+\$0
LBL	steel mesh	+\$0
LBM	crisp linen	+\$0
LBN	classic linen	+\$0
LBP	casual linen	+\$0
LBQ	white twill	+\$0
WL	sandstone	+\$0
WN	warm grey neutral	+\$0
HF	inner tone light	+\$0
HM	natural maple	+\$0
HP	light anigre	+\$0
HT	inner tone	+\$0
HX	aged cherry	+\$0
HY	walnut on cherry	+\$0
LU	soft white	+\$0
OG	honey maple	+\$0

120° Corner Surface, Extended 90° Ends

FTE44.
FTS44.
FTT44.

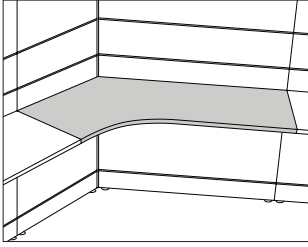

Product Information

Description

This 24"-deep, 120° corner surface hangs from frames and has a left- or right-hand extension with a 90° end. It has a laminate top and thermoplastic edge, a veneer top and edge, or a painted top and edge. Laminate and veneer surfaces are 1¼" thick. Painted Formcoat® surfaces are 1" thick. There is a 1" gap at the back of the surface for standard plug head and cord passage.

Notes

For additional size, shape, cable management, and finish options, see Vary Easy Program in Appendices.

Order appropriate supports separately; 2 supports are required for each surface (left and right side):

- Open support, tapered foot, frame attached (FT294.)
- Open support, architectural foot, frame attached (FT2A1.)
- Support panel, tapered foot, frame attached (FT291.)
- Support panel, frame attached (FT2E2.)
- Surface cantilever (FT290.)

A corner support bracket is included. Center supports are included for 60"-wide surfaces.

Dimensions

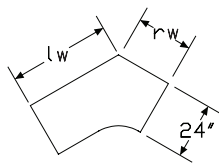

90° Extended Left

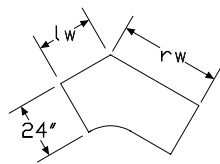

90° Extended Right

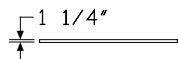

Laminate, Veneer



Painted

Specification Information

Step 1.

FT

Step 2. Edge

- S44.** squared-edge
T44. thin-edge
E44. eased-edge

Step 3. Width

- 2436** 24" wide left x 36" wide right
2442 24" wide left x 42" wide right
2448 24" wide left x 48" wide right
2460 24" wide left x 60" wide right
3036 30" wide left x 36" wide right
3042 30" wide left x 42" wide right
3048 30" wide left x 48" wide right
3060 30" wide left x 60" wide right
3624 36" wide left x 24" wide right
3630 36" wide left x 30" wide right
3642 36" wide left x 42" wide right
3648 36" wide left x 48" wide right
3660 36" wide left x 60" wide right
4224 42" wide left x 24" wide right
4230 42" wide left x 30" wide right
4236 42" wide left x 36" wide right
4824 48" wide left x 24" wide right
4830 48" wide left x 30" wide right
4836 48" wide left x 36" wide right
6024 60" wide left x 24" wide right
6030 60" wide left x 30" wide right
6036 60" wide left x 36" wide right

Step 4. Surface Material

For squared-edge (S44.)

- L** laminate top/thermoplastic edge
W veneer top/veneer edge **A**
P painted Formcoat® top/edge

For thin-edge (T44.)

- L** laminate top/thermoplastic edge
W veneer top/veneer edge **A**
P painted Formcoat® top/edge

For eased-edge (E44.)

- P** painted Formcoat® top/edge

120° Corner Surface, Extended
90° Ends *continued*

Step 5. Attachment

F Canvas frame attached surface

Prices for Steps 1-5.

	F
FTS44. 2436 L	\$543
W	\$1269
P	\$626
2442 L	\$568
W	\$1321
P	\$653
2448 L	\$586
W	\$1359
P	\$676
2460 L	\$630
W	\$1450
P	\$724
3036 L	\$624
W	\$1442
P	\$719
3042 L	\$651
W	\$1499
P	\$749
3048 L	\$674
W	\$1544
P	\$775
3060 L	\$722
W	\$1647
P	\$829
3624 L	\$543
W	\$1269
P	\$626
3630 L	\$624
W	\$1442
P	\$719
3642 L	\$711
W	\$1629
P	\$820
3648 L	\$735
W	\$1677
P	\$846
3660 L	\$788
W	\$1789
P	\$907
4224 L	\$568
W	\$1321
P	\$653

4230 L	\$651
W	\$1499
P	\$749
4236 L	\$711
W	\$1629
P	\$820
4824 L	\$586
W	\$1359
P	\$676
4830 L	\$674
W	\$1544
P	\$775
4836 L	\$735
W	\$1677
P	\$846
6024 L	\$630
W	\$1450
P	\$724
6030 L	\$722
W	\$1647
P	\$829
6036 L	\$788
W	\$1789
P	\$907
	F
FTT44. 2436 L	\$753
W	\$1509
P	\$659
2442 L	\$787
W	\$1569
P	\$689
2448 L	\$813
W	\$1614
P	\$713
2460 L	\$873
W	\$1725
P	\$764
3036 L	\$864
W	\$1714
P	\$757
3042 L	\$902
W	\$1781
P	\$790
3048 L	\$932
W	\$1835
P	\$816

120° Corner Surface, Extended
90° Ends *continued*

Canvas Office Landscape® Work Surfaces

3060 L	\$999
W	\$1957
P	\$875
3624 L	\$753
W	\$1509
P	\$659
3630 L	\$863
W	\$1714
P	\$757
3642 L	\$987
W	\$1936
P	\$863
3648 L	\$1019
W	\$1992
P	\$891
3660 L	\$1092
W	\$2125
P	\$956
4224 L	\$787
W	\$1569
P	\$689
4230 L	\$901
W	\$1781
P	\$790
4236 L	\$987
W	\$1936
P	\$863
4824 L	\$813
W	\$1614
P	\$713
4830 L	\$932
W	\$1835
P	\$816
4836 L	\$1019
W	\$1992
P	\$891
6024 L	\$873
W	\$1725
P	\$764
6030 L	\$999
W	\$1957
P	\$876
6036 L	\$1092
W	\$2125
P	\$956

FTE44. 2436 P	\$666
2442 P	\$696
2448 P	\$720
2460 P	\$772
3036 P	\$765
3042 P	\$798
3048 P	\$824
3060 P	\$885
3624 P	\$666
3630 P	\$765
3642 P	\$872
3648 P	\$900
3660 P	\$965
4224 P	\$696
4230 P	\$798
4236 P	\$872
4824 P	\$720
4830 P	\$824
4836 P	\$900
6024 P	\$772
6030 P	\$885
6036 P	\$965

Step 6.

Top Finish

For laminate top/thermoplastic edge (L)

8Q	folkstone grey	+\$0
91	white	+\$0
98	studio white	+\$0
CL	cool grey neutral	+\$0
HF	inner tone light A	+\$0
HT	inner tone A	+\$0
LU	soft white	+\$0
WL	sandstone	+\$0
WN	warm grey neutral	+\$0
76	light brown walnut	+\$0
HM	natural maple	+\$0
HP	light anigre	+\$0
HX	aged cherry	+\$0
HY	walnut on cherry	+\$0
LA	light ash A	+\$0
LBA	clear on ash	+\$0
LBR	phantom ecru	+\$0
LBS	phantom cocoa	+\$0
LBU	medium matte walnut	+\$0

120° Corner Surface, Extended
90° Ends *continued*

LBV	warm grey teak	+\$0	LBA	clear on ash	+\$0
LBB	oak on ash	+\$0	LBR	phantom ecru	+\$0
LBC	walnut on ash	+\$0	LBS	phantom cocoa	+\$0
LBD	dark brown walnut	+\$0	LBU	medium matte walnut	+\$0
LBE	medium red walnut	+\$0	LBV	warm grey teak	+\$0
OG	honey maple A	+\$0	LBB	oak on ash	+\$0
LBF	neutral twill	+\$0	LBC	walnut on ash	+\$0
LBG	sarum twill	+\$0	LBD	dark brown walnut	+\$0
LBH	earthen twill	+\$0	LBE	medium red walnut	+\$0
LBJ	graphite twill	+\$0	LBF	neutral twill	+\$0
LBQ	white twill	+\$0	LBG	sarum twill	+\$0
LBK	pewter mesh	+\$0	LBH	earthen twill	+\$0
LBL	steel mesh	+\$0	LBJ	graphite twill	+\$0
LBM	crisp linen	+\$0	LBK	pewter mesh	+\$0
LBN	classic linen	+\$0	LBL	steel mesh	+\$0
LBP	casual linen	+\$0	LBM	crisp linen	+\$0
<hr/>					
Top/Edge Finish: Wood Veneer					
<i>For veneer top/veneer edge (W)</i>					
2U	light brown walnut	+\$110	WL	sandstone	+\$0
40	dark brown walnut	+\$110	WN	warm grey neutral	+\$0
ED	aged cherry	+\$110	HF	inner tone light	+\$0
EK	medium red walnut	+\$110	HM	natural maple	+\$0
EW	medium matte walnut	+\$110	HP	light anigre	+\$0
ET	clear on ash A	+\$110	HT	inner tone	+\$0
EU	oak on ash A	+\$110	HX	aged cherry	+\$0
EV	walnut on ash A	+\$110	HY	walnut on cherry	+\$0
UL	natural maple	+\$110	LU	soft white	+\$0
UX	walnut on cherry	+\$110	OG	honey maple	+\$0

<hr/>					
Top/Edge Finish: Opaque Formcoat®					
<i>For painted Formcoat® top/edge (P)</i>					
8Q	folkstone grey	+\$0			
91	white	+\$0			
CL	cool grey neutral	+\$0			
LU	soft white	+\$0			
WL	sandstone	+\$0			
WN	warm grey neutral	+\$0			

<hr/>					
Step 7. Edge Finish					
<i>For laminate top/thermoplastic edge (L)</i>					
76	light brown walnut	+\$0			
8Q	folkstone grey	+\$0			
91	white	+\$0			
98	studio white	+\$0			
CL	cool grey neutral	+\$0			
LA	light ash	+\$0			

Peninsula Surface, Rectangular End FTS34.

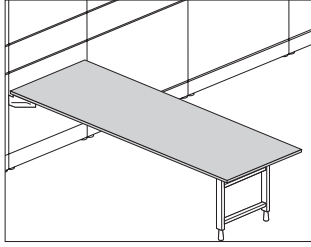

Product Information

Description

This squared-edge peninsula surface attaches to a frame, wall strips, or can be supported by a low credenza or various support components to create a freestanding desk. It has a laminate top and thermoplastic edge, laminate top with a thermoplastic backed plywood edge, veneer top and edge, or painted top and edge. Laminate and veneer surfaces are 1 1/4" thick. Painted Formcoat® surfaces are 1" thick. When hanging from a frame or wall strips there is a 1" gap at the back of the surface for standard plug head and cord passage.

Notes

For additional product options, see Vary Easy Program in Appendices.

Peninsula surface requires support at both ends of the surface.

To support the peninsula end of the surface, order 1 of the following supports separately:

- Open support leg, tapered foot, peninsula/d-shaped surface attached (FT2F2.)
- Open support leg, architectural foot, peninsula/d-shaped surface attached (FT2A2.)
- Square open support leg, peninsula attached (FV2D1.)
- Support leg, post (FV689.)
- Universal support leg, post (FT2B2.)

For surface attachment bracket (D) option:

- 2 ganging brackets are included for attaching peninsula surface to another surface at 90 degrees.
- Surface will only attach to front edge of squared-edge surfaces.

For Canvas frame attached surface (F) option:

- Attachment hardware is included.
- When attaching surface to a frame, match depth of surface to width of frame.

For no brackets, for freestanding or use with low credenza (S) option:

Order the following support products separately:

- Closed support leg (FV2E2.)
- Open support leg, architectural foot, peninsula/d-shaped surface attached (FT2A2.B)
- Square open support leg (FV2D2.)
- Support leg, post (FV689.)
- Universal post leg (FT2B2.)
- Surface support, low credenza, adjustable height (FT299.)
- Surface support, low credenza, fixed height (FT298.)

Stiffener (FV696.) is required for any laminate or veneer surface 54" wide or wider and painted formcoat surfaces 48" wide or wider that cannot use a center cantilever. See Canvas Office Landscape® Planning Guide for specific stiffener guidelines.

Dimensions

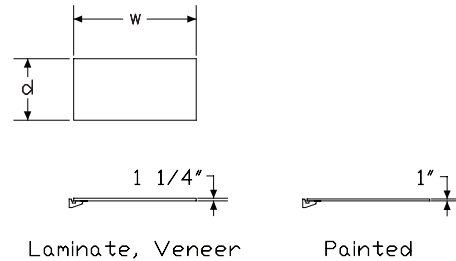

Peninsula Surface, Rectangular
End *continued*

Specification Information

Step 1.

FT

Step 2. Edge

S34. squared-edge

Step 3. Depth

24 24" deep
30 30" deep
36 36" deep

Step 4. Width

48 48" wide
54 54" wide
60 60" wide
66 66" wide
72 72" wide

Step 5. Surface Material

L laminate top/thermoplastic edge
W veneer top/veneer edge **A**
P painted Formcoat® top/edge
U laminate top/universal edge **A**

Step 6. Attachment

D surface attachment bracket
F Canvas frame attachment brackets
S no brackets, for free standing or use with low credenza

Prices for Steps 1-6.

	LD	LF	LS	WD	WF	WS
FTS34. 24 48	\$236	258	193	571	594	524
54	\$285	306	242	662	687	615
60	\$324	345	281	750	775	702
66	\$367	388	324	842	865	794
72	\$408	431	367	931	954	884
30 48	\$330	351	288	749	773	701
54	\$384	404	341	853	877	806
60	\$440	461	397	979	1002	932
66	\$500	522	457	1102	1125	1053
72	\$558	580	517	1220	1243	1171
36 48	\$469	489	426	1037	1061	989
54	\$478	499	436	1045	1068	998
60	\$544	566	502	1196	1220	1149
66	\$623	645	581	1349	1372	1302
72	\$697	720	655	1497	1521	1449

	PD	PF	PS	UD	UF	US
FTS34. 24 48	\$297	297	254	236	258	193
54	\$352	352	311	285	306	242
60	\$397	397	354	324	345	281
66	\$446	446	403	367	388	324
72	\$494	494	452	408	431	367
30 48	\$404	404	363	330	351	288
54	\$466	466	423	384	404	341
60	\$530	530	487	440	461	397
66	\$600	600	557	500	522	457
72	\$667	667	624	558	580	517
36 48	\$563	563	521	469	489	426
54	\$575	575	532	478	499	436
60	\$651	651	608	544	566	502
66	\$741	741	698	623	645	581
72	\$827	827	785	697	720	655

Step 7.

Top Finish

For laminate top/thermoplastic edge (L) or laminate top/universal edge (U)

8Q	folkstone grey	+\$0
91	white	+\$0
98	studio white	+\$0
CL	cool grey neutral	+\$0
HF	inner tone light A	+\$0
HT	inner tone A	+\$0
LU	soft white	+\$0
WL	sandstone	+\$0
WN	warm grey neutral	+\$0
76	light brown walnut	+\$0
HM	natural maple	+\$0
HP	light anigre	+\$0
HX	aged cherry	+\$0
HY	walnut on cherry	+\$0
LA	light ash A	+\$0
LBA	clear on ash	+\$0
LBR	phantom ecru	+\$0
LBS	phantom cocoa	+\$0
LBU	medium matte walnut	+\$0
LBV	warm grey teak	+\$0
LBB	oak on ash	+\$0
LBC	walnut on ash	+\$0
LBD	dark brown walnut	+\$0
LBE	medium red walnut	+\$0
OG	honey maple A	+\$0

Peninsula Surface, Rectangular End *continued*

LBF	neutral twill	+\$0
LBG	sarum twill	+\$0
LBH	earthen twill	+\$0
LBJ	graphite twill	+\$0
LBQ	white twill	+\$0
LBK	pewter mesh	+\$0
LBL	steel mesh	+\$0
LBM	crisp linen	+\$0
LBN	classic linen	+\$0
LBP	casual linen	+\$0

Top/Edge Finish: Wood Veneer

For veneer top/veneer edge (W)

2U	light brown walnut A	+\$85
40	dark brown walnut A	+\$85
ED	aged cherry A	+\$85
EK	medium red walnut A	+\$85
EW	medium matte walnut A	+\$85
ET	clear on ash A	+\$85
EU	oak on ash A	+\$85
EV	walnut on ash A	+\$85
UL	natural maple A	+\$85
UX	walnut on cherry A	+\$85

Top/Edge Finish: Opaque Formcoat®

For painted Formcoat® top/edge (P)

8Q	folkstone grey	+\$0
91	white	+\$0
CL	cool grey neutral	+\$0
LU	soft white	+\$0
WL	sandstone	+\$0
WN	warm grey neutral	+\$0

Step 8. Edge Finish

For laminate top/thermoplastic edge (L)

76	light brown walnut	+\$0
8Q	folkstone grey	+\$0
91	white	+\$0
98	studio white	+\$0
CL	cool grey neutral	+\$0
LA	light ash	+\$0
LBA	clear on ash	+\$0
LBR	phantom ecru	+\$0
LBS	phantom cocoa	+\$0
LBU	medium matte walnut	+\$0
LBV	warm grey teak	+\$0

LBB	oak on ash	+\$0
LBC	walnut on ash	+\$0
LBD	dark brown walnut	+\$0
LBE	medium red walnut	+\$0
LBF	neutral twill	+\$0
LBG	sarum twill	+\$0
LBH	earthen twill	+\$0
LBJ	graphite twill	+\$0
LBK	pewter mesh	+\$0
LBL	steel mesh	+\$0
LBM	crisp linen	+\$0
LBN	classic linen	+\$0
LBP	casual linen	+\$0
LBQ	white twill	+\$0
WL	sandstone	+\$0
WN	warm grey neutral	+\$0
HF	inner tone light	+\$0
HM	natural maple	+\$0
HP	light anigre	+\$0
HT	inner tone	+\$0
HX	aged cherry	+\$0
HY	walnut on cherry	+\$0
LU	soft white	+\$0
OG	honey maple	+\$0

For laminate top/universal edge (U)

PLY	plywood edge A	+\$50
------------	--	-------

Step 9. Bracket Finish

For Canvas frame attachment brackets (F)

8Q	folkstone grey	+\$0
98	studio white	+\$0
WL	sandstone	+\$0

Bright Sand Texture Paint

91	white	+\$0
CL	cool grey neutral	+\$0
G1	graphite	+\$0
WN	warm grey neutral	+\$0

Metallic Paint

CN	metallic champagne	+\$0
EH	metallic bronze	+\$0
MS	metallic silver	+\$0

Peninsula Surface, Rectangular End, Transition Left

FTE57.
FTE58.
FTT57.
FTT58.

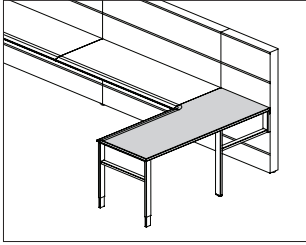

Product Information

Description

This peninsula surface attaches to a frame, wall strips, or is supported by various support components to create a freestanding desk. It is available with a partial thin- or eased-edge on the user side and a squared edge on the guest side. It abuts a thin- or eased-edge rectangular surface on the users left side creating an L-shaped configuration. Thin-edge surfaces have a laminate top and thermoplastic edge, a veneer top and edge, or a painted top and edge. Eased-edge surfaces have a painted top and edge. Laminate and veneer surfaces are 1¹/₄" thick. Painted Formcoat® surfaces are 1" thick. When hanging from a frame or wall strips there is a 1" gap at the back of the surface for standard plug head and cord passage.

Notes

For additional product options, see Vary Easy Program in Appendices.

Peninsula surface requires support at both ends of the surface.

To support the peninsula end of the surface, order 1 of the following supports separately:

- Open support leg, tapered foot, peninsula/d-shaped surface attached (FT2F2.)
- Open support leg, architectural foot, peninsula/d-shaped surface attached (FT2A2.)
- Square open support leg, peninsula attached (FV2D1.)
- Support leg, post (FV689.)
- Universal support leg, post (FT2B2.)

For Canvas frame attached surface (F) option:

- Attachment hardware is included.
- When attaching surface to a frame, match depth of surface to width of frame.

For no brackets, for freestanding or use with low credenza (S) option:

Order the following support products separately:

- Closed support leg (FV2E2.), eased edge only
- Open support leg, architectural foot, peninsula/d-shaped surface attached (FT2A2.B)
- Square open support leg (FV2D2.), eased edge only
- Support leg, post (FV689.)
- Universal post leg (FT2B2.)

Stiffener (FV696.) is required for any laminate or veneer surface 54" wide or wider and painted formcoat surfaces 48" wide or wider that cannot use a center cantilever. See Canvas Office Landscape Planning Guide for specific stiffener guidelines.

Work surface-attached screens may attach to the squared-edge side.

The open shelf organizer (FF900.) does not work with an eased-edge peninsula surface.

Dimensions

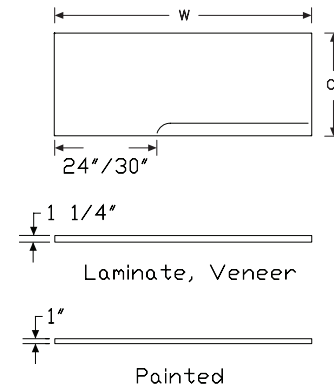

Peninsula Surface, Rectangular End, Transition Left *continued*

Specification Information

Step 1.

FT

Step 2. Edge

- T57.** thin-edge, transition left, 24" deep adjoining surface
- E57.** eased-edge, transition left, 24" deep adjoining surface
- T58.** thin-edge, transition left, 30" deep adjoining surface
- E58.** eased-edge, transition left, 30" deep adjoining surface

Step 3. Depth

- 24** 24" deep
- 30** 30" deep
- 36** 36" deep

Step 4. Width

- 60** 60" wide
- 66** 66" wide
- 72** 72" wide

Step 5. Surface Material

For thin-edge, transition left, 24" deep adjoining surface (T57.)

- L** laminate top/thermoplastic edge
- W** veneer top/veneer edge A
- P** painted Formcoat® top/edge

For thin-edge, transition left, 30" deep adjoining surface (T58.)

- L** laminate top/thermoplastic edge
- W** veneer top/veneer edge A
- P** painted Formcoat® top/edge

For eased-edge, transition left, 24" deep adjoining surface (E57.)

- P** painted Formcoat® top/edge

For eased-edge, transition left, 30" deep adjoining surface (E58.)

- P** painted Formcoat® top/edge

Step 6. Attachment

- F** Canvas frame attachment brackets
- S** no brackets, for free standing or use with low credenza

Prices for Steps 1-6.

	LF	LS	WF	WS	PF	PS
FTT57. 24 60	\$457	415	997	949	584	541
66	\$512	469	1107	1060	651	608
72	\$564	522	1215	1167	720	677

30 60	\$577	534	1237	1190	736	693
66	\$652	609	1398	1350	831	789
72	\$726	683	1547	1500	926	883
36 60	\$706	665	1540	1492	901	859
66	\$806	763	1746	1699	1028	985
72	\$898	856	1936	1889	1146	1103

FTE57. 24 60	—	—	—	—	\$598	555
66	—	—	—	—	\$667	624
72	—	—	—	—	\$736	692
30 60	—	—	—	—	\$754	711
66	—	—	—	—	\$852	808
72	—	—	—	—	\$947	903
36 60	—	—	—	—	\$924	880
66	—	—	—	—	\$1053	1009
72	—	—	—	—	\$1173	1130

FTT58. 24 60	\$453	411	987	940	578	536
66	\$507	464	1096	1050	645	602
72	\$558	517	1203	1156	713	670
30 60	\$571	529	1225	1178	729	686
66	\$646	603	1384	1337	823	781
72	\$719	676	1532	1485	917	874
36 60	\$699	658	1525	1477	892	851
66	\$798	756	1729	1682	1018	975
72	\$889	848	1917	1870	1135	1092

FTE58. 24 60	—	—	—	—	\$598	555
66	—	—	—	—	\$667	624
72	—	—	—	—	\$736	692
30 60	—	—	—	—	\$754	711
66	—	—	—	—	\$852	808
72	—	—	—	—	\$947	903
36 60	—	—	—	—	\$924	880
66	—	—	—	—	\$1053	1009
72	—	—	—	—	\$1173	1130

Step 7.

Top Finish

For laminate top/thermoplastic edge (L)

8Q	folkstone grey	+\$0
91	white	+\$0
98	studio white	+\$0
CL	cool grey neutral	+\$0
HF	inner tone light A	+\$0
HT	inner tone A	+\$0

Peninsula Surface, Rectangular
End, Transition Left *continued*

LU	soft white	+\$0
WL	sandstone	+\$0
WN	warm grey neutral	+\$0
76	light brown walnut	+\$0
HM	natural maple	+\$0
HP	light anigre	+\$0
HX	aged cherry	+\$0
HY	walnut on cherry	+\$0
LA	light ash A	+\$0
LBA	clear on ash	+\$0
LBR	phantom ecru	+\$0
LBS	phantom cocoa	+\$0
LBU	medium matte walnut	+\$0
LBV	warm grey teak	+\$0
LBB	oak on ash	+\$0
LBC	walnut on ash	+\$0
LBD	dark brown walnut	+\$0
LBE	medium red walnut	+\$0
OG	honey maple A	+\$0
LBF	neutral twill	+\$0
LBG	sarum twill	+\$0
LBH	earthen twill	+\$0
LBJ	graphite twill	+\$0
LBQ	white twill	+\$0
LBK	pewter mesh	+\$0
LBL	steel mesh	+\$0
LBM	crisp linen	+\$0
LBN	classic linen	+\$0
LBP	casual linen	+\$0

Top/Edge Finish: Wood Veneer

For veneer top/veneer edge (W)

2U	light brown walnut A	+\$85
40	dark brown walnut A	+\$85
ED	aged cherry A	+\$85
EK	medium red walnut A	+\$85
EW	medium matte walnut A	+\$85
ET	clear on ash A	+\$85
EU	oak on ash A	+\$85
EV	walnut on ash A	+\$85
UL	natural maple A	+\$85
UX	walnut on cherry A	+\$85

Top/Edge Finish: Opaque Formcoat®

For painted Formcoat® top/edge (P)

8Q	folkstone grey	+\$0
91	white	+\$0
CL	cool grey neutral	+\$0
LU	soft white	+\$0
WL	sandstone	+\$0
WN	warm grey neutral	+\$0

Step 8. Edge Finish

For laminate top/thermoplastic edge (L)

76	light brown walnut	+\$0
8Q	folkstone grey	+\$0
91	white	+\$0
98	studio white	+\$0
CL	cool grey neutral	+\$0
LA	light ash	+\$0
LBA	clear on ash	+\$0
LBR	phantom ecru	+\$0
LBS	phantom cocoa	+\$0
LBU	medium matte walnut	+\$0
LBV	warm grey teak	+\$0
LBB	oak on ash	+\$0
LBC	walnut on ash	+\$0
LBD	dark brown walnut	+\$0
LBE	medium red walnut	+\$0
LBF	neutral twill	+\$0
LBG	sarum twill	+\$0
LBH	earthen twill	+\$0
LBJ	graphite twill	+\$0
LBK	pewter mesh	+\$0
LBL	steel mesh	+\$0
LBM	crisp linen	+\$0
LBN	classic linen	+\$0
LBP	casual linen	+\$0
LBQ	white twill	+\$0
WL	sandstone	+\$0
WN	warm grey neutral	+\$0
HF	inner tone light	+\$0
HM	natural maple	+\$0
HP	light anigre	+\$0
HT	inner tone	+\$0
HX	aged cherry	+\$0
HY	walnut on cherry	+\$0
LU	soft white	+\$0
OG	honey maple	+\$0

Peninsula Surface, Rectangular
 End, Transition Left *continued*

Canvas Office Landscape® Work Surfaces

Step 9. Bracket Finish		
<i>For Canvas frame attachment brackets (F)</i>		
91	white	+\$0
CL	cool grey neutral	+\$0
G1	graphite	+\$0
WN	warm grey neutral	+\$0
8Q	folkstone grey	+\$0
98	studio white	+\$0
WL	sandstone	+\$0
Metallic Paint		
CN	metallic champagne	+\$0
EH	metallic bronze	+\$0
MS	metallic silver	+\$0

Peninsula Surface, Rectangular End, Transition Right

FTE55.
FTE56.
FTT55.
FTT56.

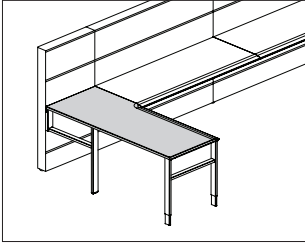

Product Information

Description

This peninsula surface attaches to a frame, wall strips, or is supported by various support components to create a freestanding desk. It is available with a partial thin- or eased-edge on the user side and a squared edge on the guest side. It abuts a thin- or eased-edge rectangular surface on the users right side creating an L-shaped configuration. Thin-edge surfaces have a laminate top and thermoplastic edge, a veneer top and edge, or a painted top and edge. Eased-edge surfaces have a painted top and edge. Laminate and veneer surfaces are 1¹/₄" thick. Painted Formcoat® surfaces are 1" thick. When hanging from a frame or wall strips there is a 1" gap at the back of the surface for standard plug head and cord passage.

Notes

For additional product options, see Vary Easy Program in Appendices.

Peninsula surface requires support at both ends of the surface.

To support the peninsula end of the surface, order 1 of the following supports separately:

- Open support leg, tapered foot, peninsula/d-shaped surface attached (FT2F2.)
- Open support leg, architectural foot, peninsula/d-shaped surface attached (FT2A2.)
- Square open support leg, peninsula attached (FV2D1.)
- Support leg, post (FV689.)
- Universal support leg, post (FT2B2.)

For Canvas frame attached surface (F) option:

- Attachment hardware is included.
- When attaching surface to a frame, match depth of surface to width of frame.

For no brackets, for freestanding or use with low credenza (S) option:

Order the following support products separately:

- Closed support leg (FV2E2.), eased edge only
- Open support leg, architectural foot, peninsula/d-shaped surface attached (FT2A2.B)
- Square open support leg (FV2D2.), eased edge only
- Support leg, post (FV689.)
- Universal post leg (FT2B2.)

Stiffener (FV696.) is required for any laminate or veneer surface 54" wide or wider and painted formcoat surfaces 48" wide or wider that cannot use a center cantilever. See Canvas Office Landscape Planning Guide for specific stiffener guidelines.

Work surface-attached screens may attach to the squared-edge side.

The open shelf organizer (FF900.) does not work with an eased-edge peninsula surface.

Dimensions

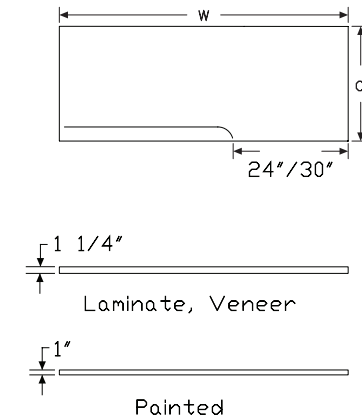

Peninsula Surface, Rectangular End, Transition Right *continued*

Specification Information

Step 1.

FT

Step 2. Edge

- T55.** thin-edge, transition right, 24" deep adjoining surface
- T56.** thin-edge, transition right, 30" deep adjoining surface
- E55.** eased-edge, transition right, 24" deep adjoining surface
- E56.** eased-edge, transition right, 30" deep adjoining surface

Step 3. Depth

- 24** 24" deep
- 30** 30" deep
- 36** 36" deep

Step 4. Width

- 60** 60" wide
- 66** 66" wide
- 72** 72" wide

Step 5. Surface Material

For thin-edge, transition right, 24" deep adjoining surface (T55.)

- L** laminate top/thermoplastic edge
- W** veneer top/veneer edge A
- P** painted Formcoat® top/edge

For thin-edge, transition right, 30" deep adjoining surface (T56.)

- L** laminate top/thermoplastic edge
- W** veneer top/veneer edge A
- P** painted Formcoat® top/edge

For eased-edge, transition right, 24" deep adjoining surface (E55.)

- P** painted Formcoat® top/edge

For eased-edge, transition right, 30" deep adjoining surface (E56.)

- P** painted Formcoat® top/edge

Step 6. Attachment

- F** Canvas frame attachment brackets
- S** no brackets, for free standing or use with low credenza

Prices for Steps 1-6.

	LF	LS	WF	WS	PF	PS
FTT55. 24 60	\$457	415	997	949	584	541
66	\$512	469	1107	1060	651	608
72	\$564	522	1215	1167	720	677

30 60	\$577	534	1237	1190	736	693
66	\$652	609	1398	1350	831	789
72	\$726	683	1547	1500	926	883
36 60	\$706	665	1540	1492	901	859
66	\$806	763	1746	1699	1028	985
72	\$898	856	1936	1889	1146	1103

FTE55. 24 60	—	—	—	—	\$598	555
66	—	—	—	—	\$667	624
72	—	—	—	—	\$736	692
30 60	—	—	—	—	\$754	711
66	—	—	—	—	\$852	808
72	—	—	—	—	\$947	903
36 60	—	—	—	—	\$924	880
66	—	—	—	—	\$1053	1009
72	—	—	—	—	\$1173	1130

FTE56. 24 60	—	—	—	—	\$598	555
66	—	—	—	—	\$667	624
72	—	—	—	—	\$736	692
30 60	—	—	—	—	\$754	711
66	—	—	—	—	\$852	808
72	—	—	—	—	\$947	903
36 60	—	—	—	—	\$924	880
66	—	—	—	—	\$1053	1009
72	—	—	—	—	\$1173	1130

Step 7.

Top Finish

For laminate top/thermoplastic edge (L)

8Q	folkstone grey	+\$0
91	white	+\$0
98	studio white	+\$0
CL	cool grey neutral	+\$0
HF	inner tone light A	+\$0
HT	inner tone A	+\$0

Peninsula Surface, Rectangular End, Transition Right *continued*

LU	soft white	+\$0
WL	sandstone	+\$0
WN	warm grey neutral	+\$0
76	light brown walnut	+\$0
HM	natural maple	+\$0
HP	light anigre	+\$0
HX	aged cherry	+\$0
HY	walnut on cherry	+\$0
LA	light ash A	+\$0
LBA	clear on ash	+\$0
LBR	phantom ecru	+\$0
LBS	phantom cocoa	+\$0
LBU	medium matte walnut	+\$0
LBV	warm grey teak	+\$0
LBB	oak on ash	+\$0
LBC	walnut on ash	+\$0
LBD	dark brown walnut	+\$0
LBE	medium red walnut	+\$0
OG	honey maple A	+\$0
LBF	neutral twill	+\$0
LBG	sarum twill	+\$0
LBH	earthen twill	+\$0
LBJ	graphite twill	+\$0
LBQ	white twill	+\$0
LBK	pewter mesh	+\$0
LBL	steel mesh	+\$0
LBM	crisp linen	+\$0
LBN	classic linen	+\$0
LBP	casual linen	+\$0

Top/Edge Finish: Wood Veneer

For veneer top/veneer edge (W)

2U	light brown walnut A	+\$85
40	dark brown walnut A	+\$85
ED	aged cherry A	+\$85
EK	medium red walnut A	+\$85
EW	medium matte walnut A	+\$85
ET	clear on ash A	+\$85
EU	oak on ash A	+\$85
EV	walnut on ash A	+\$85
UL	natural maple A	+\$85
UX	walnut on cherry A	+\$85

Top/Edge Finish: Opaque Formcoat®

For painted Formcoat® top/edge (P)

8Q	folkstone grey	+\$0
91	white	+\$0
CL	cool grey neutral	+\$0
LU	soft white	+\$0
WL	sandstone	+\$0
WN	warm grey neutral	+\$0

Step 8. Edge Finish

For laminate top/thermoplastic edge (L)

76	light brown walnut	+\$0
8Q	folkstone grey	+\$0
91	white	+\$0
98	studio white	+\$0
CL	cool grey neutral	+\$0
LA	light ash	+\$0
LBA	clear on ash	+\$0
LBR	phantom ecru	+\$0
LBS	phantom cocoa	+\$0
LBU	medium matte walnut	+\$0
LBV	warm grey teak	+\$0
LBB	oak on ash	+\$0
LBC	walnut on ash	+\$0
LBD	dark brown walnut	+\$0
LBE	medium red walnut	+\$0
LBF	neutral twill	+\$0
LBG	sarum twill	+\$0
LBH	earthen twill	+\$0
LBJ	graphite twill	+\$0
LBK	pewter mesh	+\$0
LBL	steel mesh	+\$0
LBM	crisp linen	+\$0
LBN	classic linen	+\$0
LBP	casual linen	+\$0
LBQ	white twill	+\$0
WL	sandstone	+\$0
WN	warm grey neutral	+\$0
HF	inner tone light	+\$0
HM	natural maple	+\$0
HP	light anigre	+\$0
HT	inner tone	+\$0
HX	aged cherry	+\$0
HY	walnut on cherry	+\$0
LU	soft white	+\$0
OG	honey maple	+\$0

Peninsula Surface, Rectangular End, Transition Right *continued*

Canvas Office Landscape® Work Surfaces

Step 9. Bracket Finish		
<i>For Canvas frame attachment brackets (F)</i>		
91	white	+\$0
CL	cool grey neutral	+\$0
G1	graphite	+\$0
WN	warm grey neutral	+\$0
8Q	folkstone grey	+\$0
98	studio white	+\$0
WL	sandstone	+\$0
Metallic Paint		
CN	metallic champagne	+\$0
EH	metallic bronze	+\$0
MS	metallic silver	+\$0

Peninsula Surface, Rectangular
End, Transition, Double

FTE53.
FTE54.
FTT53.
FTT54.

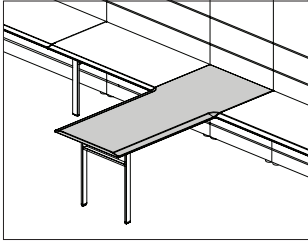

Product Information

Description

This peninsula surface attaches to a frame, wall strips, or is supported by various support components to create a freestanding desk. It attaches to a thin- or eased-edge rectangular surface at the left or right position creating a T-shaped configuration. Thin-edge surfaces have a laminate top and thermoplastic edge, a veneer top and edge, or a painted top and edge. Eased-edge surfaces have a painted top and edge. Laminate and veneer surfaces are 1 1/4" thick. Painted Formcoat® surfaces are 1" thick. When hanging from a frame or wall strips there is a 1" gap at the back of the surface for standard plug head and cord passage.

Notes

For additional product options, see Vary Easy Program in Appendices.
Peninsula surface requires support at both ends of the surface.

To support the peninsula end of the surface, order 1 of the following supports separately:

- Open support leg, architectural foot, peninsula/d-shaped surface attached (FT2A2.A), inset leg position
- Square open support leg, peninsula attached (FV2D1.)
- Support leg, post (FV689.)
- Universal support leg, post (FT2B2.)

For Canvas frame attached surface (F) option:

- Attachment hardware is included.
- When attaching surface to a frame, match depth of surface to width of frame.

For no brackets, for freestanding or use with low credenza (S) option:

Order the following support products separately:

- Closed support leg (FV2E2.)
- Open support leg, architectural foot, peninsula/d-shaped surface attached (FT2A2.B)
- Square open support leg (FV2D2.)
- Support leg, post (FV689.)
- Universal post leg (FT2B2.)

Stiffener (FV696.) is required for any laminate or veneer surface 54" wide or wider and painted formcoat surfaces 48" wide or wider that cannot use a center cantilever. See Canvas Office Landscape® Planning Guide for specific stiffener guidelines.

Work surface-attached screens and modesty panels do not work with this peninsula surface.

The open shelf organizer (FF900.) does not work with an eased-edge peninsula surface.

Dimensions

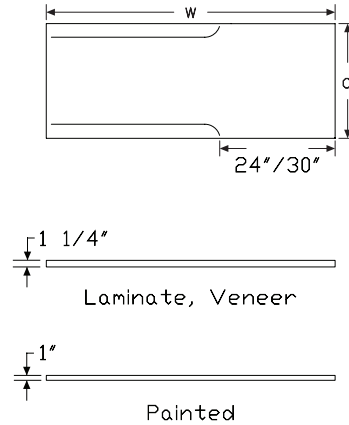

Peninsula Surface, Rectangular End, Transition, Double *continued*

Specification Information

Step 1.

FT

Step 2. Edge

- T53.** thin-edge transition double, 24" deep adjoining surface
- E53.** eased-edge transition double, 24" deep adjoining surface
- T54.** thin-edge transition double, 30" deep adjoining surface
- E54.** eased-edge transition double, 30" deep adjoining surface

Step 3. Depth

- 24** 24" deep
- 30** 30" deep
- 36** 36" deep

Step 4. Width

- 60** 60" wide
- 66** 66" wide
- 72** 72" wide

Step 5. Surface Material

For thin-edge transition double, 24" deep adjoining surface (T53.)

- L** laminate top/thermoplastic edge
- W** veneer top/veneer edge A
- P** painted Formcoat® top/edge

For thin-edge transition double, 30" deep adjoining surface (T54.)

- L** laminate top/thermoplastic edge
- W** veneer top/veneer edge A
- P** painted Formcoat® top/edge

For eased-edge transition double, 24" deep adjoining surface (E53.)

- P** painted Formcoat® top/edge

For eased-edge transition double, 30" deep adjoining surface (E54.)

- P** painted Formcoat® top/edge

Step 6. Attachment

- F** Canvas frame attachment brackets
- S** no brackets, for free standing or use with low credenza

Prices for Steps 1-6.

	LF	LS	WF	WS	PF	PS
FTT53. 24 60	\$460	418	1001	953	586	544
66	\$513	470	1108	1062	653	611
72	\$565	523	1217	1170	721	678

30 60	\$577	535	1238	1191	736	693
66	\$652	610	1398	1351	832	790
72	\$725	682	1547	1498	925	882
36 60	\$707	665	1539	1491	900	859
66	\$804	762	1744	1695	1026	984
72	\$895	854	1931	1884	1143	1100

FTE53. 24 60	—	—	—	—	\$605	562
66	—	—	—	—	\$675	632
72	—	—	—	—	\$745	701
30 60	—	—	—	—	\$761	718
66	—	—	—	—	\$860	817
72	—	—	—	—	\$956	912
36 60	—	—	—	—	\$932	888
66	—	—	—	—	\$1061	1018
72	—	—	—	—	\$1182	1139

FTT54. 24 60	\$460	418	1001	953	586	544
66	\$513	470	1108	1062	653	611
72	\$565	523	1217	1170	721	678
30 60	\$577	535	1238	1191	736	693
66	\$652	610	1398	1351	832	790
72	\$725	682	1547	1498	925	882
36 60	\$707	665	1539	1491	900	859
66	\$804	762	1744	1695	1026	984
72	\$895	854	1931	1884	1143	1100

FTE54. 24 60	—	—	—	—	\$605	562
66	—	—	—	—	\$675	632
72	—	—	—	—	\$745	701
30 60	—	—	—	—	\$761	718
66	—	—	—	—	\$860	817
72	—	—	—	—	\$956	912
36 60	—	—	—	—	\$932	888
66	—	—	—	—	\$1061	1018
72	—	—	—	—	\$1182	1139

Step 7.

Top Finish

For laminate top/thermoplastic edge (L)

8Q	folkstone grey	+\$0
91	white	+\$0
98	studio white	+\$0
CL	cool grey neutral	+\$0
HF	inner tone light A	+\$0
HT	inner tone A	+\$0

Peninsula Surface, Rectangular
End, Transition, Double *continued*

LU	soft white	+\$0
WL	sandstone	+\$0
WN	warm grey neutral	+\$0
76	light brown walnut	+\$0
HM	natural maple	+\$0
HP	light anigre	+\$0
HX	aged cherry	+\$0
HY	walnut on cherry	+\$0
LA	light ash A	+\$0
LBA	clear on ash	+\$0
LBR	phantom ecru	+\$0
LBS	phantom cocoa	+\$0
LBU	medium matte walnut	+\$0
LBV	warm grey teak	+\$0
LBB	oak on ash	+\$0
LBC	walnut on ash	+\$0
LBD	dark brown walnut	+\$0
LBE	medium red walnut	+\$0
OG	honey maple A	+\$0
LBF	neutral twill	+\$0
LBG	sarum twill	+\$0
LBH	earthen twill	+\$0
LBJ	graphite twill	+\$0
LBQ	white twill	+\$0
LBK	pewter mesh	+\$0
LBL	steel mesh	+\$0
LBM	crisp linen	+\$0
LBN	classic linen	+\$0
LBP	casual linen	+\$0

Top/Edge Finish: Wood Veneer

For veneer top/veneer edge (W)

2U	light brown walnut A	+\$85
40	dark brown walnut A	+\$85
ED	aged cherry A	+\$85
EK	medium red walnut A	+\$85
EW	medium matte walnut A	+\$85
ET	clear on ash A	+\$85
EU	oak on ash A	+\$85
EV	walnut on ash A	+\$85
UL	natural maple A	+\$85
UX	walnut on cherry A	+\$85

Top/Edge Finish: Opaque Formcoat®

For painted Formcoat® top/edge (P)

8Q	folkstone grey	+\$0
91	white	+\$0
CL	cool grey neutral	+\$0
LU	soft white	+\$0
WL	sandstone	+\$0
WN	warm grey neutral	+\$0

Step 8. Edge Finish

For laminate top/thermoplastic edge (L)

76	light brown walnut	+\$0
8Q	folkstone grey	+\$0
91	white	+\$0
98	studio white	+\$0
CL	cool grey neutral	+\$0
LA	light ash	+\$0
LBA	clear on ash	+\$0
LBR	phantom ecru	+\$0
LBS	phantom cocoa	+\$0
LBU	medium matte walnut	+\$0
LBV	warm grey teak	+\$0
LBB	oak on ash	+\$0
LBC	walnut on ash	+\$0
LBD	dark brown walnut	+\$0
LBE	medium red walnut	+\$0
LBF	neutral twill	+\$0
LBG	sarum twill	+\$0
LBH	earthen twill	+\$0
LBJ	graphite twill	+\$0
LBK	pewter mesh	+\$0
LBL	steel mesh	+\$0
LBM	crisp linen	+\$0
LBN	classic linen	+\$0
LBP	casual linen	+\$0
LBQ	white twill	+\$0
WL	sandstone	+\$0
WN	warm grey neutral	+\$0
HF	inner tone light	+\$0
HM	natural maple	+\$0
HP	light anigre	+\$0
HT	inner tone	+\$0
HX	aged cherry	+\$0
HY	walnut on cherry	+\$0
LU	soft white	+\$0
OG	honey maple	+\$0

Peninsula Surface, Rectangular
 End, Transition, Double *continued*

Canvas Office Landscape® Work Surfaces

Step 9. Bracket Finish		
<i>For Canvas frame attachment brackets (F)</i>		
91	white	+\$0
CL	cool grey neutral	+\$0
G1	graphite	+\$0
WN	warm grey neutral	+\$0
8Q	folkstone grey	+\$0
98	studio white	+\$0
WL	sandstone	+\$0
Metallic Paint		
CN	metallic champagne	+\$0
EH	metallic bronze	+\$0
MS	metallic silver	+\$0

Peninsula Surface, Rectangular
End, Single

FTE51.
FTT51.

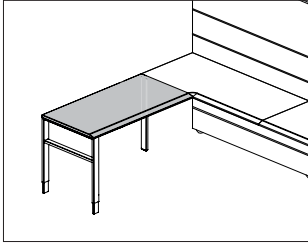

Product Information

Description

This peninsula surface attaches to a single or double transition rectangular surface creating an L- or U-shaped configuration or it can be supported by a low credenza or various support components to create a freestanding desk. It is available with a thin- or eased-edge on the user side and a squared edge on the guest side. Thin-edge surfaces have a laminate top and thermoplastic edge, a veneer top and edge, or a painted top and edge. Eased-edge surfaces have a painted top and edge. Laminate and veneer surfaces are 1 1/4" thick. Painted Formcoat® surfaces are 1" thick.

Notes

For additional product options, see Vary Easy Program in Appendices.
Peninsula surface requires support at both ends of the surface.

To support the peninsula end of the surface, order 1 of the following supports separately:

- Open support leg, tapered foot, peninsula/d-shaped surface attached (FT2F2.)
- Open support leg, architectural foot, peninsula/d-shaped surface attached (FT2A2.)
- Square open support leg, peninsula attached (FV2D1.)
- Support leg, post (FV689.)
- Universal support leg, post (FT2B2.)

For surface attachment bracket (D) option:

- 2 ganging brackets are included for attaching peninsula surface to another surface at 90 degrees.
- Peninsula surface attaches to the front edge of the rectangular surface, transition, single (FTT1A., FTT1B., FTT1C., FTT1D., FTE1A., FTE1B., FTE1C., FTE1D.) or rectangular surface, transition, double (FTT1H., FTT1J., FTT1K., FTE1H., FTE1J., FTE1K.).

For no brackets, for freestanding or use with low credenza (S) option:
Order the following support products separately:

- Open support leg, architectural foot, peninsula/d-shaped surface attached (FT2A2.B)
- Support leg, post (FV689.)
- Universal post leg (FT2B2.)
- Surface support, low credenza, adjustable height (FT299.)
- Surface support, low credenza, fixed height (FT298.)

Stiffener (FV696.) is required for any laminate or veneer surface 54" wide or wider and painted formcoat surfaces 48" wide or wider that cannot use a center cantilever. See Canvas Office Landscape® Planning Guide for specific stiffener guidelines.

Work surface-attached screens may attach to the squared-edge side.
The open shelf organizer (FF900.) does not work with the eased-edge peninsula surface.

Dimensions

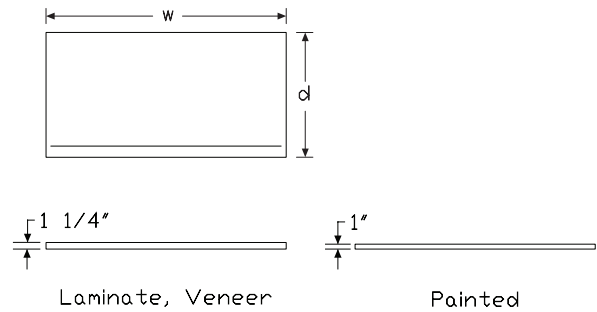

Peninsula Surface, Rectangular End, Single *continued*

Specification Information

Step 1.

FT

Step 2. Edge

T51. thin-edge

E51. eased-edge

Step 3. Depth

24 24" deep

30 30" deep

Step 4. Width

48 48" wide

54 54" wide

60 60" wide

66 66" wide

72 72" wide

Step 5. Surface Material

For thin-edge (T51.)

L laminate top/thermoplastic edge

W veneer top/veneer edge **A**

P painted Formcoat® top/edge

For eased-edge (E51.)

P painted Formcoat® top/edge

Step 6. Attachment

D surface attachment bracket

S no brackets, for free standing or use with low credenza

Prices for Steps 1-6.

	LD	LS	WD	WS	PD	PS
FTT51. 24 48	\$391	348	825	778	486	444
54	\$451	408	952	904	564	522
60	\$500	457	1044	997	626	584
66	\$553	512	1154	1107	693	651
72	\$606	564	1263	1215	761	720
30 48	\$482	440	1009	961	603	560
54	\$548	506	1142	1095	687	645
60	\$619	577	1284	1237	778	736
66	\$694	652	1445	1398	874	831
72	\$768	726	1595	1547	967	926

FTE51. 24 48	—	—	—	—	\$497	454
54	—	—	—	—	\$577	534
60	—	—	—	—	\$642	598
66	—	—	—	—	\$711	667
72	—	—	—	—	\$779	736
30 48	—	—	—	—	\$618	574
54	—	—	—	—	\$703	660
60	—	—	—	—	\$797	754
66	—	—	—	—	\$895	852
72	—	—	—	—	\$990	947

Step 7.

Top Finish

For laminate top/thermoplastic edge (L)

8Q	folkstone grey	+\$0
91	white	+\$0
98	studio white	+\$0
CL	cool grey neutral	+\$0
HF	inner tone light A	+\$0
HT	inner tone A	+\$0
LU	soft white	+\$0
WL	sandstone	+\$0
WN	warm grey neutral	+\$0
76	light brown walnut	+\$0
HM	natural maple	+\$0
HP	light anigre	+\$0
HX	aged cherry	+\$0
HY	walnut on cherry	+\$0
LA	light ash A	+\$0
LBA	clear on ash	+\$0
LBR	phantom ecru	+\$0
LBS	phantom cocoa	+\$0
LBU	medium matte walnut	+\$0
LBV	warm grey teak	+\$0
LBB	oak on ash	+\$0
LBC	walnut on ash	+\$0
LBD	dark brown walnut	+\$0
LBE	medium red walnut	+\$0
OG	honey maple A	+\$0
LBF	neutral twill	+\$0
LBG	sarum twill	+\$0
LBH	earthen twill	+\$0
LBJ	graphite twill	+\$0
LBQ	white twill	+\$0
LBK	pewter mesh	+\$0
LBL	steel mesh	+\$0

Peninsula Surface, Rectangular End, Single *continued*

LBM	crisp linen	+\$0
LBN	classic linen	+\$0
LBP	casual linen	+\$0

Top/Edge Finish: Wood Veneer

For veneer top/veneer edge (W)

2U	light brown walnut <input type="checkbox"/> A	+\$85
40	dark brown walnut <input type="checkbox"/> A	+\$85
ED	aged cherry <input type="checkbox"/> A	+\$85
EK	medium red walnut <input type="checkbox"/> A	+\$85
EW	medium matte walnut <input type="checkbox"/> A	+\$85
ET	clear on ash <input type="checkbox"/> A	+\$85
EU	oak on ash <input type="checkbox"/> A	+\$85
EV	walnut on ash <input type="checkbox"/> A	+\$85
UL	natural maple <input type="checkbox"/> A	+\$85
UX	walnut on cherry <input type="checkbox"/> A	+\$85

Top/Edge Finish: Opaque Formcoat®

For painted Formcoat® top/edge (P)

8Q	folkstone grey	+\$0
91	white	+\$0
CL	cool grey neutral	+\$0
LU	soft white	+\$0
WL	sandstone	+\$0
WN	warm grey neutral	+\$0

Step 8. Edge Finish

For laminate top/thermoplastic edge (L)

76	light brown walnut	+\$0
8Q	folkstone grey	+\$0
91	white	+\$0
98	studio white	+\$0
CL	cool grey neutral	+\$0
LA	light ash	+\$0
LBA	clear on ash	+\$0
LBR	phantom ecru	+\$0
LBS	phantom cocoa	+\$0
LBU	medium matte walnut	+\$0
LBV	warm grey teak	+\$0
LBB	oak on ash	+\$0
LBC	walnut on ash	+\$0
LBD	dark brown walnut	+\$0
LBE	medium red walnut	+\$0
LBF	neutral twill	+\$0
LBG	sarum twill	+\$0
LBH	earthen twill	+\$0
LBJ	graphite twill	+\$0

LBK	pewter mesh	+\$0
LBL	steel mesh	+\$0
LBM	crisp linen	+\$0
LBN	classic linen	+\$0
LBP	casual linen	+\$0
LBQ	white twill	+\$0
WL	sandstone	+\$0
WN	warm grey neutral	+\$0
HF	inner tone light	+\$0
HM	natural maple	+\$0
HP	light anigre	+\$0
HT	inner tone	+\$0
HX	aged cherry	+\$0
HY	walnut on cherry	+\$0
LU	soft white	+\$0
OG	honey maple	+\$0

Peninsula Surface, Rectangular End, Center

FTE50.
FTT50.

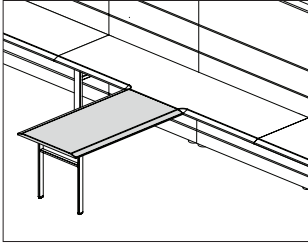

Product Information

Description

This peninsula surface attaches to a rectangular surface, transition, center or is supported by various support components to create a freestanding desk. Thin-edge surfaces have a laminate top and thermoplastic edge, a veneer top and edge, or a painted top and edge. Eased-edge surfaces have a painted top and edge. Laminate and veneer surfaces are 1 1/4" thick. Painted Formcoat® surfaces are 1" thick.

Notes

For additional product options, see Vary Easy Program in Appendices.

Peninsula surface requires support at both ends of surface.

To support the peninsula end of the surface, order 1 of the following supports separately:

- Open support leg, architectural foot, peninsula/d-shaped surface attached (FT2A2.A), inset leg position
- Square open support leg, peninsula attached (FV2D1.)
- Support leg, post (FV689.)
- Universal support leg, post (FT2B2.)

For surface attachment bracket (D) option:

- 2 ganging brackets are included for attaching peninsula surface to another surface at 90 degrees.
- Peninsula surface attaches to the front edge of the rectangular surface, transition, center (FTT1E., FTT1F., FTT1G., FTE1E., FTE1F., FTE1G.).

For no brackets, for freestanding or use with low credenza (S) option:

Order the following support products separately:

- Support leg, post (FV689.)
- Universal post leg (FT2B2.)

Stiffener (FV696.) is required for any laminate or veneer surface 54" wide or wider and painted formcoat surfaces 48" wide or wider that cannot use a center cantilever. See Canvas Office Landscape® Planning Guide for specific stiffener guidelines.

Work surface-attached screens and modesty panels do not work with this peninsula surface.

The open shelf organizer (FF900.) does not work with the eased-edge peninsula surface.

Dimensions

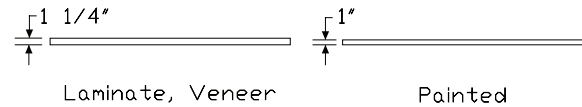
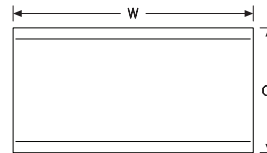

Peninsula Surface, Rectangular
End, Center *continued*

Specification Information

Step 1.

FT

Step 2. Edge

T50. thin-edge

E50. eased-edge

Step 3. Depth

24 24" deep

30 30" deep

36 36" deep

Step 4. Width

48 48" wide

54 54" wide

60 60" wide

66 66" wide

72 72" wide

Step 5. Surface Material

For thin-edge (T50.)

L laminate top/thermoplastic edge

W veneer top/veneer edge **A**

P painted Formcoat® top/edge

For eased-edge (E50.)

P painted Formcoat® top/edge

Step 6. Attachment

D surface attachment bracket

S no brackets, for free standing or use with low credenza

Prices for Steps 1-6.

	LD	LS	WD	WS	PD	PS
FTT50. 24 48	\$391	348	825	778	486	444
54	\$451	408	952	904	564	522
60	\$500	457	1044	997	626	584
66	\$553	512	1154	1107	693	651
72	\$606	564	1263	1215	761	720
30 48	\$482	440	1009	961	603	560
54	\$548	506	1142	1095	687	645
60	\$619	577	1284	1237	778	736
66	\$694	652	1445	1398	874	831
72	\$768	726	1595	1547	967	926

36 48	\$654	611	1413	1365	823	781
54	\$667	624	1428	1381	839	797
60	\$749	706	1587	1540	944	901
66	\$848	806	1793	1746	1070	1028
72	\$941	898	1983	1936	1188	1146
FTE50. 24 48	—	—	—	—	\$502	458
54	—	—	—	—	\$583	539
60	—	—	—	—	\$648	604
66	—	—	—	—	\$718	674
72	—	—	—	—	\$787	743
30 48	—	—	—	—	\$624	580
54	—	—	—	—	\$710	667
60	—	—	—	—	\$805	761
66	—	—	—	—	\$904	860
72	—	—	—	—	\$1000	956
36 48	—	—	—	—	\$851	807
54	—	—	—	—	\$867	824
60	—	—	—	—	\$977	933
66	—	—	—	—	\$1107	1063
72	—	—	—	—	\$1229	1185

Step 7.

Top Finish

For laminate top/thermoplastic edge (L)

8Q	folkstone grey	+\$0
91	white	+\$0
98	studio white	+\$0
CL	cool grey neutral	+\$0
HF	inner tone light A	+\$0
HT	inner tone A	+\$0
LU	soft white	+\$0
WL	sandstone	+\$0
WN	warm grey neutral	+\$0
76	light brown walnut	+\$0
HM	natural maple	+\$0
HP	light anigre	+\$0
HX	aged cherry	+\$0
HY	walnut on cherry	+\$0
LA	light ash A	+\$0
LBA	clear on ash	+\$0
LBR	phantom ecru	+\$0
LBS	phantom cocoa	+\$0
LBU	medium matte walnut	+\$0
LBV	warm grey teak	+\$0
LBB	oak on ash	+\$0

Peninsula Surface, Rectangular End, Center *continued*

LBC	walnut on ash	+\$0
LBD	dark brown walnut	+\$0
LBE	medium red walnut	+\$0
OG	honey maple <input type="checkbox"/> A	+\$0
LBF	neutral twill	+\$0
LBG	sarum twill	+\$0
LBH	earthen twill	+\$0
LBJ	graphite twill	+\$0
LBQ	white twill	+\$0
LBK	pewter mesh	+\$0
LBL	steel mesh	+\$0
LBM	crisp linen	+\$0
LBN	classic linen	+\$0
LBP	casual linen	+\$0

Top/Edge Finish: Wood Veneer

For veneer top/veneer edge (W)

2U	light brown walnut <input type="checkbox"/> A	+\$85
40	dark brown walnut <input type="checkbox"/> A	+\$85
ED	aged cherry <input type="checkbox"/> A	+\$85
EK	medium red walnut <input type="checkbox"/> A	+\$85
EW	medium matte walnut <input type="checkbox"/> A	+\$85
ET	clear on ash <input type="checkbox"/> A	+\$85
EU	oak on ash <input type="checkbox"/> A	+\$85
EV	walnut on ash <input type="checkbox"/> A	+\$85
UL	natural maple <input type="checkbox"/> A	+\$85
UX	walnut on cherry <input type="checkbox"/> A	+\$85

Top/Edge Finish: Opaque Formcoat®

For painted Formcoat® top/edge (P)

8Q	folkstone grey	+\$0
91	white	+\$0
CL	cool grey neutral	+\$0
LU	soft white	+\$0
WL	sandstone	+\$0
WN	warm grey neutral	+\$0

Step 8. Edge Finish

For laminate top/thermoplastic edge (L)

76	light brown walnut	+\$0
8Q	folkstone grey	+\$0
91	white	+\$0
98	studio white	+\$0
CL	cool grey neutral	+\$0
LA	light ash	+\$0
LBA	clear on ash	+\$0
LBR	phantom ecru	+\$0

LBS	phantom cocoa	+\$0
LBU	medium matte walnut	+\$0
LBV	warm grey teak	+\$0
LBB	oak on ash	+\$0
LBC	walnut on ash	+\$0
LBD	dark brown walnut	+\$0
LBE	medium red walnut	+\$0
LBF	neutral twill	+\$0
LBG	sarum twill	+\$0
LBH	earthen twill	+\$0
LBJ	graphite twill	+\$0
LBK	pewter mesh	+\$0
LBL	steel mesh	+\$0
LBM	crisp linen	+\$0
LBN	classic linen	+\$0
LBP	casual linen	+\$0
LBQ	white twill	+\$0
WL	sandstone	+\$0
WN	warm grey neutral	+\$0
HF	inner tone light	+\$0
HM	natural maple	+\$0
HP	light anigre	+\$0
HT	inner tone	+\$0
HX	aged cherry	+\$0
HY	walnut on cherry	+\$0
LU	soft white	+\$0
OG	honey maple	+\$0

Peninsula Surface, Round End FTS35.

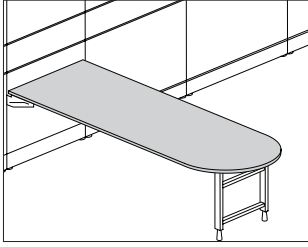

Product Information

Description

This squared-edge peninsula surface attaches to a frame, wall strips, or is supported by various support components to create a freestanding desk. It has a laminate top and thermoplastic edge, a veneer top and edge, or a painted top and edge. Laminate and veneer surfaces are 1 1/4" thick. Painted Formcoat® surfaces are 1" thick. When hanging from a frame or wall strips there is a 1" gap at the back of the surface for standard plug head and cord passage.

Notes

For additional product options, see Vary Easy Program in Appendices.

Peninsula surface requires support at both ends of the surface.

To support the peninsula end of the surface, order 1 of the following supports separately:

- Open support leg, tapered foot, peninsula/d-shaped surface attached (FT2F2.)
- Open support leg, architectural foot, peninsula/d-shaped surface attached (FT2A2.A) inset leg position
- Square open support leg, peninsula attached (FV2D1.)
- Support leg, post (FV689.)
- Universal support leg, post (FT2B2.)

For surface attachment bracket (D) option:

- 2 ganging brackets are included for attaching peninsula surface to another surface at 90 degrees.
- Surface will only attach to front edge of squared-edge surfaces.

For Canvas frame attached surface (F) option:

- Attachment hardware is included.
- When attaching surface to a frame, match depth of surface to width of frame.

For no brackets, for freestanding or use with low credenza (S) option:

Order the following support products separately:

- Closed support leg (FV2E2.)
- Open support leg, architectural foot, peninsula/d-shaped surface attached (FT2A2.B)
- Square open support leg (FV2D2.)
- Support leg, post (FV689.)
- Universal support leg, post (FT2B2.)

Stiffener (FV696.) is required for any laminate or veneer surface 54" wide or wider and painted formcoat surfaces 48" wide or wider that cannot use a center cantilever. See Canvas Office Landscape® Planning Guide for specific stiffener guidelines.

Dimensions

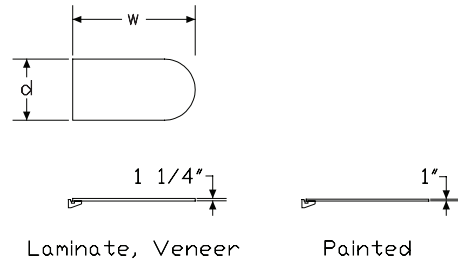

Peninsula Surface, Round End

continued

Canvas Office Landscape® Work Surfaces

Specification Information

Step 1.

FT

Step 2. Edge

S35. squared-edge

Step 3. Depth

24 24" deep

30 30" deep

36 36" deep

Step 4. Width

48 48" wide

54 54" wide

60 60" wide

66 66" wide

72 72" wide

Step 5. Surface Material

L laminate top/thermoplastic edge

W veneer top/veneer edge **A**

P painted Formcoat® top/edge

Step 6. Attachment

D surface attachment bracket

F Canvas frame attached surface

S no brackets, for free standing or use with low credenza

Prices for Steps 1-6.

	LD	LF	LS	WD	WF	WS
FTS35. 24 48	\$257	277	214	778	801	731
54	\$310	330	267	844	867	797
60	\$365	386	322	911	935	864
66	\$439	459	396	1006	1030	958
72	\$515	535	472	1098	1122	1051
30 48	\$390	411	347	979	1002	932
54	\$444	466	401	1045	1068	998
60	\$499	521	456	1112	1137	1065
66	\$575	596	532	1207	1231	1160
72	\$649	670	606	1302	1325	1254
36 48	\$531	552	488	1199	1223	1152
54	\$595	616	552	1279	1302	1230
60	\$638	659	596	1333	1357	1286
66	\$718	738	675	1431	1453	1383
72	\$795	816	752	1524	1548	1477

	PD	PF	PS
FTS35. 24 48	\$319	319	276
54	\$381	381	338
60	\$444	444	401
66	\$529	529	486
72	\$616	616	574
30 48	\$473	473	431
54	\$535	535	492
60	\$599	599	556
66	\$685	685	643
72	\$771	771	729
36 48	\$635	635	593
54	\$707	707	666
60	\$758	758	717
66	\$849	849	807
72	\$940	940	897

Step 7.

Top Finish

For laminate top/thermoplastic edge (L)

8Q	folkstone grey		+\$0
91	white		+\$0
98	studio white		+\$0
CL	cool grey neutral		+\$0
HF	inner tone light A		+\$0
HT	inner tone A		+\$0
LU	soft white		+\$0
WL	sandstone		+\$0
WN	warm grey neutral		+\$0
76	light brown walnut		+\$0
HM	natural maple		+\$0
HP	light anigre		+\$0
HX	aged cherry		+\$0
HY	walnut on cherry		+\$0
LA	light ash A		+\$0
LBA	clear on ash		+\$0
LBR	phantom ecru		+\$0
LBS	phantom cocoa		+\$0
LBU	medium matte walnut		+\$0
LBV	warm grey teak		+\$0
LBB	oak on ash		+\$0
LBC	walnut on ash		+\$0
LBD	dark brown walnut		+\$0
LBE	medium red walnut		+\$0
OG	honey maple A		+\$0
LBF	neutral twill		+\$0

Peninsula Surface, Round End

continued

LBG	sarum twill	+\$0
LBH	earthen twill	+\$0
LBJ	graphite twill	+\$0
LBQ	white twill	+\$0
LBK	pewter mesh	+\$0
LBL	steel mesh	+\$0
LBM	crisp linen	+\$0
LBN	classic linen	+\$0
LBP	casual linen	+\$0

Top/Edge Finish: Wood Veneer

For veneer top/veneer edge (W)

2U	light brown walnut <input type="checkbox"/>	+\$85
40	dark brown walnut <input type="checkbox"/>	+\$85
ED	aged cherry <input type="checkbox"/>	+\$85
EK	medium red walnut <input type="checkbox"/>	+\$85
EW	medium matte walnut <input type="checkbox"/>	+\$85
ET	clear on ash <input type="checkbox"/>	+\$85
EU	oak on ash <input type="checkbox"/>	+\$85
EV	walnut on ash <input type="checkbox"/>	+\$85
UL	natural maple <input type="checkbox"/>	+\$85
UX	walnut on cherry <input type="checkbox"/>	+\$85

Top/Edge Finish: Opaque Formcoat®

For painted Formcoat® top/edge (P)

8Q	folkstone grey	+\$0
91	white	+\$0
CL	cool grey neutral	+\$0
LU	soft white	+\$0
WL	sandstone	+\$0
WN	warm grey neutral	+\$0

Step 8. Edge Finish

For laminate top/thermoplastic edge (L)

76	light brown walnut	+\$0
8Q	folkstone grey	+\$0
91	white	+\$0
98	studio white	+\$0
CL	cool grey neutral	+\$0
LA	light ash	+\$0
LBA	clear on ash	+\$0
LBR	phantom ecru	+\$0
LBS	phantom cocoa	+\$0
LBU	medium matte walnut	+\$0
LBV	warm grey teak	+\$0
LBB	oak on ash	+\$0
LBC	walnut on ash	+\$0

LBD	dark brown walnut	+\$0
LBE	medium red walnut	+\$0
LBF	neutral twill	+\$0
LBG	sarum twill	+\$0
LBH	earthen twill	+\$0
LBJ	graphite twill	+\$0
LBK	pewter mesh	+\$0
LBL	steel mesh	+\$0
LBM	crisp linen	+\$0
LBN	classic linen	+\$0
LBP	casual linen	+\$0
LBQ	white twill	+\$0
WL	sandstone	+\$0
WN	warm grey neutral	+\$0
HF	inner tone light	+\$0
HM	natural maple	+\$0
HP	light anigre	+\$0
HT	inner tone	+\$0
HX	aged cherry	+\$0
HY	walnut on cherry	+\$0
LU	soft white	+\$0
OG	honey maple	+\$0

Step 9. Bracket Finish

For Canvas frame attached surface (F)

8Q	folkstone grey	+\$0
98	studio white	+\$0
WL	sandstone	+\$0

Bright Sand Texture Paint

91	white	+\$0
CL	cool grey neutral	+\$0
G1	graphite	+\$0
WN	warm grey neutral	+\$0

Metallic Paint

CN	metallic champagne	+\$0
EH	metallic bronze	+\$0
MS	metallic silver	+\$0

Peninsula Surface, Round-End,
Transition Left

FTE67.
FTE68.
FTT67.
FTT68.

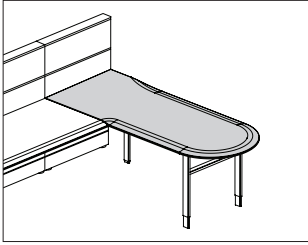

Canvas Office Landscape® Work Surfaces

Product Information

Description

This peninsula surface attaches to a frame, wall strips, or is supported by various support components to create a freestanding desk. It abuts a thin- or eased-edge rectangular surface on the users left side creating an L-shaped configuration. Thin-edge surfaces have a laminate top and thermoplastic edge, a veneer top and edge, or a painted top and edge. Eased-edge surfaces have a painted top and edge. Laminate and veneer surfaces are 1 1/4" thick. Painted Formcoat® surfaces are 1" thick. When hanging from a frame or wall strips there is a 1" gap at the back of the surface for standard plug head and cord passage.

Notes

For additional product options, see Vary Easy Program in Appendices.
Peninsula surface requires support on both ends of the surface.

To support the peninsula end of the surface, order 1 of the following supports separately:

- Open support leg, architectural foot, peninsula/d-shaped surface attached (FT2A2.A), inset leg position
- Square open support leg, peninsula attached (FV2D1.)
- Support leg, post (FV689.)
- Universal support leg, post (FT2B2.)

For Canvas frame attached surface (F) option:

- Attachment hardware is included.
- When attaching surface to a frame, match depth of surface to width of frame.

For no brackets, for freestanding or use with low credenza (S) option:

Order the following support products separately:

- Closed support leg (FV2E2.), eased edge only
- Open support leg, architectural foot, peninsula/d-shaped surface attached (FT2A2.B)
- Square open support leg (FV2D2.), eased edge only
- Support leg, post (FV689.)
- Universal post leg (FT2B2.)

Stiffener (FV696.) is required for any laminate or veneer surface 54" wide or wider and painted formcoat surfaces 48" wide or wider that cannot use a center cantilever. See Canvas Office Landscape® Planning Guide for specific stiffener guidelines.

Work surface-attached screens and modesty panels do not work with this peninsula surface.

The open shelf organizer (FF900.) does not work with an eased-edge peninsula surface.

Dimensions

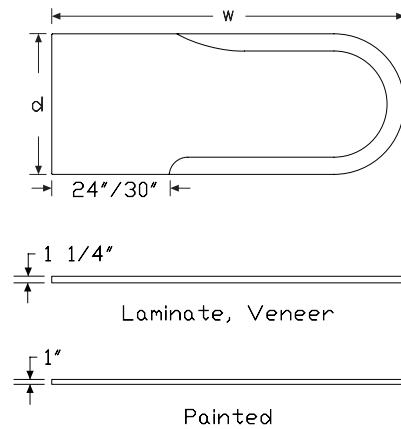

Peninsula Surface, Round-End,
Transition Left *continued*

Specification Information

Step 1.

FT

Step 2. Edge

- T67.** thin-edge, transition left, 24" deep
- E67.** eased-edge, transition left, 24" deep
- T68.** thin-edge, transition left, 30" deep
- E68.** eased-edge, transition left, 30" deep

Step 3. Depth

- 24** 24" deep
- 30** 30" deep
- 36** 36" deep

Step 4. Width

- 60** 60" wide
- 66** 66" wide
- 72** 72" wide

Step 5. Surface Material

For thin-edge, transition left, 24" deep (T67.)

- L** laminate top/thermoplastic edge
- W** veneer top/veneer edge A
- P** painted Formcoat® top/edge

For thin-edge, transition left, 30" deep (T68.)

- L** laminate top/thermoplastic edge
- W** veneer top/veneer edge A
- P** painted Formcoat® top/edge

For eased-edge, transition left, 24" deep (E67.)

- P** painted Formcoat® top/edge

For eased-edge, transition left, 30" deep (E68.)

- P** painted Formcoat® top/edge

Step 6. Attachment

- F** Canvas frame attachment brackets
- S** no brackets, for freestanding

Prices for Steps 1-6.

	LF	LS	WF	WS	PF	PS
FTT67. 24 60	\$482	440	1303	1255	615	573
66	\$575	532	1506	1459	733	690
72	\$669	626	1710	1663	853	810

30 60	\$651	608	1599	1552	830	788
66	\$744	701	1770	1723	949	906
72	\$837	795	1937	1890	1068	1026

36 60	\$824	782	1804	1755	1051	1009
66	\$924	881	1979	1931	1177	1135
72	\$1020	978	2155	2106	1301	1258

FTE67. 24 60	—	—	—	—	\$630	586
66	—	—	—	—	\$751	707
72	—	—	—	—	\$874	831

30 60	—	—	—	—	\$851	807
66	—	—	—	—	\$972	929
72	—	—	—	—	\$1094	1051

36 60	—	—	—	—	\$1076	1033
66	—	—	—	—	\$1205	1162
72	—	—	—	—	\$1333	1289

FTT68. 24 60	\$477	436	1290	1243	609	567
66	\$569	527	1491	1445	726	683
72	\$662	620	1693	1647	845	802

30 60	\$645	602	1583	1537	822	780
66	\$737	694	1753	1706	940	897
72	\$829	787	1918	1871	1058	1016

36 60	\$816	774	1786	1738	1041	999
66	\$915	872	1960	1912	1165	1124
72	\$1010	968	2134	2085	1288	1246

FTE68. 24 60	—	—	—	—	\$630	586
66	—	—	—	—	\$751	707
72	—	—	—	—	\$874	831

30 60	—	—	—	—	\$851	807
66	—	—	—	—	\$972	929
72	—	—	—	—	\$1094	1051

36 60	—	—	—	—	\$1076	1033
66	—	—	—	—	\$1205	1162
72	—	—	—	—	\$1333	1289

Step 7.

Top Finish

For laminate top/thermoplastic edge (L)

8Q	folkstone grey	+\$0
91	white	+\$0
98	studio white	+\$0
CL	cool grey neutral	+\$0
HF	inner tone light A	+\$0
HT	inner tone A	+\$0

Peninsula Surface, Round-End, Transition Left *continued*

LU	soft white	+\$0
WL	sandstone	+\$0
WN	warm grey neutral	+\$0
76	light brown walnut	+\$0
HM	natural maple	+\$0
HP	light anigre	+\$0
HX	aged cherry	+\$0
HY	walnut on cherry	+\$0
LA	light ash A	+\$0
LBA	clear on ash	+\$0
LBR	phantom ecru	+\$0
LBS	phantom cocoa	+\$0
LBU	medium matte walnut	+\$0
LBV	warm grey teak	+\$0
LBB	oak on ash	+\$0
LBC	walnut on ash	+\$0
LBD	dark brown walnut	+\$0
LBE	medium red walnut	+\$0
OG	honey maple A	+\$0
LBF	neutral twill	+\$0
LBG	sarum twill	+\$0
LBH	earthen twill	+\$0
LBJ	graphite twill	+\$0
LBQ	white twill	+\$0
LBK	pewter mesh	+\$0
LBL	steel mesh	+\$0
LBM	crisp linen	+\$0
LBN	classic linen	+\$0
LBP	casual linen	+\$0

Top/Edge Finish: Wood Veneer

For veneer top/veneer edge (W)

2U	light brown walnut A	+\$85
40	dark brown walnut A	+\$85
ED	aged cherry A	+\$85
EK	medium red walnut A	+\$85
EW	medium matte walnut A	+\$85
ET	clear on ash A	+\$85
EU	oak on ash A	+\$85
EV	walnut on ash A	+\$85
UL	natural maple A	+\$85
UX	walnut on cherry A	+\$85

Top/Edge Finish: Opaque Formcoat®

For painted Formcoat® top/edge (P)

8Q	folkstone grey	+\$0
91	white	+\$0
CL	cool grey neutral	+\$0
LU	soft white	+\$0
WL	sandstone	+\$0
WN	warm grey neutral	+\$0

Step 8. Edge Finish

For laminate top/thermoplastic edge (L)

76	light brown walnut	+\$0
8Q	folkstone grey	+\$0
91	white	+\$0
98	studio white	+\$0
CL	cool grey neutral	+\$0
LA	light ash	+\$0
LBA	clear on ash	+\$0
LBR	phantom ecru	+\$0
LBS	phantom cocoa	+\$0
LBU	medium matte walnut	+\$0
LBV	warm grey teak	+\$0
LBB	oak on ash	+\$0
LBC	walnut on ash	+\$0
LBD	dark brown walnut	+\$0
LBE	medium red walnut	+\$0
LBF	neutral twill	+\$0
LBG	sarum twill	+\$0
LBH	earthen twill	+\$0
LBJ	graphite twill	+\$0
LBK	pewter mesh	+\$0
LBL	steel mesh	+\$0
LBM	crisp linen	+\$0
LBN	classic linen	+\$0
LBP	casual linen	+\$0
LBQ	white twill	+\$0
WL	sandstone	+\$0
WN	warm grey neutral	+\$0
HF	inner tone light	+\$0
HM	natural maple	+\$0
HP	light anigre	+\$0
HT	inner tone	+\$0
HX	aged cherry	+\$0
HY	walnut on cherry	+\$0
LU	soft white	+\$0
OG	honey maple	+\$0

Peninsula Surface, Round-End, Transition Left *continued*

Step 9. Bracket Finish

For Canvas frame attachment brackets (F)

91	white	+\$0
CL	cool grey neutral	+\$0
G1	graphite	+\$0
WN	warm grey neutral	+\$0
8Q	folkstone grey	+\$0
98	studio white	+\$0
WL	sandstone	+\$0

Metallic Paint

CN	metallic champagne	+\$0
EH	metallic bronze	+\$0
MS	metallic silver	+\$0

Peninsula Surface, Round-End, Transition Right

FTE65.
FTE66.
FTT65.
FTT66.

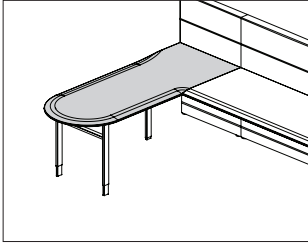

Product Information

Description

This peninsula surface attaches to a frame, wall strips, or is supported by various support components to create a freestanding desk. It abuts a thin- or eased-edge rectangular surface on the users right side creating an L-shaped configuration. Thin-edge surfaces have a laminate top and thermoplastic edge, a veneer top and edge, or a painted top and edge. Eased-edge surfaces have a painted top and edge. Laminate and veneer surfaces are 1 1/4" thick. Painted Formcoat® surfaces are 1" thick. When hanging from a frame or wall strips there is a 1" gap at the back of the surface for standard plug head and cord passage.

Notes

For additional product options, see Vary Easy Program in Appendices.

Peninsula surface requires support on both ends of surface.

To support the peninsula end of the surface, order 1 of the following supports separately:

- Open support leg, architectural foot, peninsula/d-shaped surface attached (FT2A2.A), inset leg position
- Square open support leg, peninsula attached (FV2D1.)
- Support leg, post (FV689.)
- Universal support leg, post (FT2B2.)

For Canvas frame attached surface (F) option:

- Attachment hardware is included.
- When attaching surface to a frame, match depth of surface to width of frame.

For no brackets, for freestanding or use with low credenza (S) option:

Order the following support products separately:

- Closed support leg (FV2E2.), eased edge only
- Open support leg, architectural foot, peninsula/d-shaped surface attached (FT2A2.B)
- Square open support leg (FV2D2.), eased edge only
- Support leg, post (FV689.)
- Universal post leg (FT2B2.)

Stiffener (FV696.) is required for any laminate or veneer surface 54" wide or wider and painted formcoat surfaces 48" wide or wider that cannot use a center cantilever. See Canvas Office Landscape® Planning Guide for specific stiffener guidelines.

Work surface-attached screens and modesty panels do not work with this peninsula surface.

The open shelf organizer (FF900.) does not work with an eased-edge peninsula surface.

Dimensions

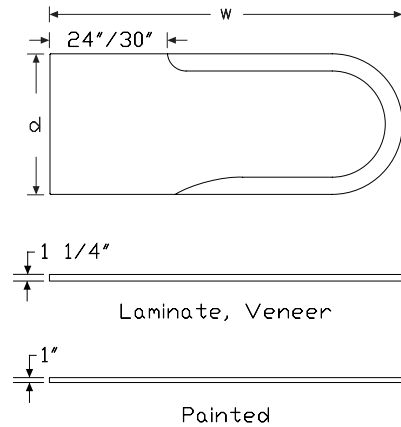

Peninsula Surface, Round-End,
Transition Right *continued*

Specification Information

Step 1.

FT

Step 2. Edge

- T65.** thin-edge, transition right, 24" deep
- E65.** eased-edge, transition right, 24" deep
- T66.** thin-edge, transition right, 30" deep
- E66.** eased-edge, transition right, 30" deep

Step 3. Depth

- 24** 24" deep
- 30** 30" deep
- 36** 36" deep

Step 4. Width

- 60** 60" wide
- 66** 66" wide
- 72** 72" wide

Step 5. Surface Material

For thin-edge, transition right, 24" deep (T65.)

- L** laminate top/thermoplastic edge
- W** veneer top/veneer edge A
- P** painted Formcoat® top/edge

For thin-edge, transition right, 30" deep (T66.)

- L** laminate top/thermoplastic edge
- W** veneer top/veneer edge A
- P** painted Formcoat® top/edge

For eased-edge, transition right, 24" deep (E65.)

- P** painted Formcoat® top/edge

For eased-edge, transition right, 30" deep (E66.)

- P** painted Formcoat® top/edge

Step 6. Attachment

- F** Canvas frame attachment brackets
- S** no brackets, for freestanding

Prices for Steps 1-6.

	LF	LS	WF	WS	PF	PS
FTT65. 24 60	\$482	440	1303	1255	615	573
66	\$575	532	1506	1459	733	690
72	\$669	626	1710	1663	853	810

30 60	\$651	608	1599	1552	830	788
66	\$744	701	1770	1723	949	906
72	\$837	795	1937	1890	1068	1026

36 60	\$824	782	1804	1755	1051	1009
66	\$924	881	1979	1931	1177	1135
72	\$1020	978	2155	2106	1301	1258

FTE65. 24 60	—	—	—	—	\$630	586
66	—	—	—	—	\$751	707
72	—	—	—	—	\$874	831

30 60	—	—	—	—	\$851	807
66	—	—	—	—	\$972	929
72	—	—	—	—	\$1094	1051

36 60	—	—	—	—	\$1076	1033
66	—	—	—	—	\$1205	1162
72	—	—	—	—	\$1333	1289

FTT66. 24 60	\$477	436	1290	1243	609	567
66	\$569	527	1491	1445	726	683
72	\$662	620	1693	1647	845	802

30 60	\$645	602	1583	1537	822	780
66	\$737	694	1753	1706	940	897
72	\$829	787	1918	1871	1058	1016

36 60	\$816	774	1786	1738	1041	999
66	\$915	872	1960	1912	1165	1124
72	\$1010	968	2134	2085	1288	1246

FTE66. 24 60	—	—	—	—	\$630	586
66	—	—	—	—	\$751	707
72	—	—	—	—	\$874	831

30 60	—	—	—	—	\$851	807
66	—	—	—	—	\$972	929
72	—	—	—	—	\$1094	1051

36 60	—	—	—	—	\$1076	1033
66	—	—	—	—	\$1205	1162
72	—	—	—	—	\$1333	1289

Step 7.

Top Finish

For laminate top/thermoplastic edge (L)

8Q	folkstone grey	+\$0
91	white	+\$0
98	studio white	+\$0
CL	cool grey neutral	+\$0
HF	inner tone light A	+\$0
HT	inner tone A	+\$0

Peninsula Surface, Round-End, Transition Right *continued*

LU	soft white	+\$0
WL	sandstone	+\$0
WN	warm grey neutral	+\$0
76	light brown walnut	+\$0
HM	natural maple	+\$0
HP	light anigre	+\$0
HX	aged cherry	+\$0
HY	walnut on cherry	+\$0
LA	light ash A	+\$0
LBA	clear on ash	+\$0
LBR	phantom ecru	+\$0
LBS	phantom cocoa	+\$0
LBU	medium matte walnut	+\$0
LBV	warm grey teak	+\$0
LBB	oak on ash	+\$0
LBC	walnut on ash	+\$0
LBD	dark brown walnut	+\$0
LBE	medium red walnut	+\$0
OG	honey maple A	+\$0
LBF	neutral twill	+\$0
LBG	sarum twill	+\$0
LBH	earthen twill	+\$0
LBJ	graphite twill	+\$0
LBQ	white twill	+\$0
LBK	pewter mesh	+\$0
LBL	steel mesh	+\$0
LBM	crisp linen	+\$0
LBN	classic linen	+\$0
LBP	casual linen	+\$0

Top/Edge Finish: Wood Veneer

For veneer top/veneer edge (W)

2U	light brown walnut A	+\$85
40	dark brown walnut A	+\$85
ED	aged cherry A	+\$85
EK	medium red walnut A	+\$85
EW	medium matte walnut A	+\$85
ET	clear on ash A	+\$85
EU	oak on ash A	+\$85
EV	walnut on ash A	+\$85
UL	natural maple A	+\$85
UX	walnut on cherry A	+\$85

Top/Edge Finish: Opaque Formcoat®

For painted Formcoat® top/edge (P)

8Q	folkstone grey	+\$0
91	white	+\$0
CL	cool grey neutral	+\$0
LU	soft white	+\$0
WL	sandstone	+\$0
WN	warm grey neutral	+\$0

Step 8. Edge Finish

For laminate top/thermoplastic edge (L)

76	light brown walnut	+\$0
8Q	folkstone grey	+\$0
91	white	+\$0
98	studio white	+\$0
CL	cool grey neutral	+\$0
LA	light ash	+\$0
LBA	clear on ash	+\$0
LBR	phantom ecru	+\$0
LBS	phantom cocoa	+\$0
LBU	medium matte walnut	+\$0
LBV	warm grey teak	+\$0
LBB	oak on ash	+\$0
LBC	walnut on ash	+\$0
LBD	dark brown walnut	+\$0
LBE	medium red walnut	+\$0
LBF	neutral twill	+\$0
LBG	sarum twill	+\$0
LBH	earthen twill	+\$0
LBJ	graphite twill	+\$0
LBK	pewter mesh	+\$0
LBL	steel mesh	+\$0
LBM	crisp linen	+\$0
LBN	classic linen	+\$0
LBP	casual linen	+\$0
LBQ	white twill	+\$0
WL	sandstone	+\$0
WN	warm grey neutral	+\$0
HF	inner tone light	+\$0
HM	natural maple	+\$0
HP	light anigre	+\$0
HT	inner tone	+\$0
HX	aged cherry	+\$0
HY	walnut on cherry	+\$0
LU	soft white	+\$0
OG	honey maple	+\$0

Peninsula Surface, Round-End, Transition Right *continued*

Step 9. Bracket Finish

For Canvas frame attachment brackets (F)

91	white	+\$0
CL	cool grey neutral	+\$0
G1	graphite	+\$0
WN	warm grey neutral	+\$0
8Q	folkstone grey	+\$0
98	studio white	+\$0
WL	sandstone	+\$0

Metallic Paint

CN	metallic champagne	+\$0
EH	metallic bronze	+\$0
MS	metallic silver	+\$0

Peninsula Surface, Round-End, Transition, Double

FTE63.
FTE64.
FTT63.
FTT64.

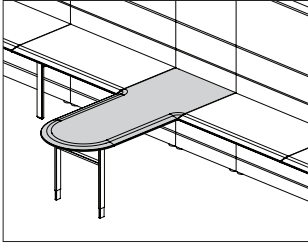

Product Information

Description

This peninsula surface attaches to a frame, wall strips, or is supported by various support components to create a freestanding desk. It attaches to a thin- or eased-edge rectangular surface at the left or right position creating a T-shaped configuration. Thin-edge surfaces have a laminate top and thermoplastic edge, a veneer top and edge, or a painted top and edge. Eased-edge surfaces have a painted top and edge. Laminate and veneer surfaces are 1/4" thick. Painted Formcoat® surfaces are 1" thick. When hanging from a frame or wall strips there is a 1" gap at the back of the surface for standard plug head and cord passage.

Notes

For additional product options, see Vary Easy Program in Appendices.

Peninsula surface requires support at both ends of the surface.

To support the peninsula end of the surface, order 1 of the following supports separately:

- Open support leg, architectural foot, peninsula/d-shaped surface attached (FT2A2.A), inset leg position
- Square open support leg, peninsula attached (FV2D1.)
- Support leg, post (FV689.)
- Universal support leg, post (FT2B2.)

For Canvas frame attached surface (F) option:

- Attachment hardware is included.
- When attaching surface to a frame, match depth of surface to width of frame.

For no brackets, for freestanding or use with low credenza (S) option:

Order the following support products separately:

- Closed support leg (FV2E2.)
- Open support leg, architectural foot, peninsula/d-shaped surface attached (FT2A2.B)
- Square open support leg (FV2D2.)
- Support leg, post (FV689.)
- Universal post leg (FT2B2.)

Stiffener (FV696.) is required for any laminate or veneer surface 54" wide or wider and painted formcoat surfaces 48" wide or wider that cannot use a center cantilever. See Canvas Office Landscape® Planning Guide for specific stiffener guidelines.

Work surface-attached screens and modesty panels do not work with this peninsula surface.

The open shelf organizer (FF900.) does not work with an eased edge peninsula surface.

Dimensions

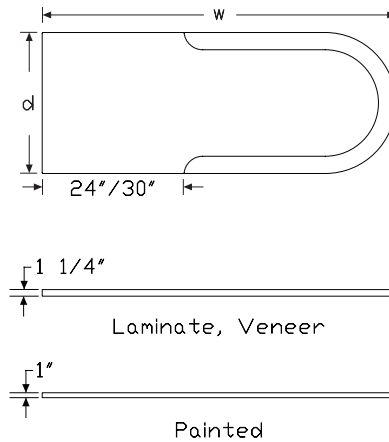

Peninsula Surface, Round-End,
Transition, Double *continued*

Specification Information

Step 1.

FT

Step 2. Edge

- T63.** thin-edge, transition double, 24" deep adjoining surface
- E63.** eased-edge, transition double, 24" deep adjoining surface
- T64.** thin-edge, transition double, 30" deep adjoining surface
- E64.** eased-edge, transition double, 30" deep adjoining surface

Step 3. Depth

- 24** 24" deep
- 30** 30" deep
- 36** 36" deep

Step 4. Width

- 60** 60" wide
- 66** 66" wide
- 72** 72" wide

Step 5. Surface Material

For thin-edge, transition double, 24" deep adjoining surface (T63.)

- L** laminate top/thermoplastic edge
- W** veneer top/veneer edge A
- P** painted Formcoat® top/edge

For thin-edge, transition double, 30" deep adjoining surface (T64.)

- L** laminate top/thermoplastic edge
- W** veneer top/veneer edge A
- P** painted Formcoat® top/edge

For eased-edge, transition double, 24" deep adjoining surface (E63.)

- P** painted Formcoat® top/edge

For eased-edge, transition double, 30" deep adjoining surface (E64.)

- P** painted Formcoat® top/edge

Step 6. Attachment

- F** Canvas frame attachment brackets
- S** no brackets, for free standing or use with low credenza

Prices for Steps 1-6.

	LF	LS	WF	WS	PF	PS
FTT63. 24 60	\$482	440	1303	1255	615	573
66	\$575	532	1506	1459	733	690
72	\$669	626	1710	1663	853	810

30 60	\$651	608	1599	1552	830	788
66	\$744	701	1770	1723	949	906
72	\$837	795	1937	1890	1068	1026

36 60	\$824	782	1804	1755	1051	1009
66	\$924	881	1979	1931	1177	1135
72	\$1020	978	2155	2106	1301	1258

FTE63. 24 60	—	—	—	—	\$630	586
66	—	—	—	—	\$751	707
72	—	—	—	—	\$874	831

30 60	—	—	—	—	\$851	807
66	—	—	—	—	\$972	929
72	—	—	—	—	\$1094	1051

36 60	—	—	—	—	\$1076	1033
66	—	—	—	—	\$1205	1162
72	—	—	—	—	\$1333	1289

FTT64. 24 60	\$477	436	1290	1243	609	567
66	\$569	527	1491	1445	726	683
72	\$662	620	1693	1647	845	802

30 60	\$645	602	1583	1537	822	780
66	\$737	694	1753	1706	940	897
72	\$829	787	1918	1871	1058	1016

36 60	\$816	774	1786	1738	1041	999
66	\$915	872	1960	1912	1165	1124
72	\$1010	968	2134	2085	1288	1246

FTE64. 24 60	—	—	—	—	\$630	586
66	—	—	—	—	\$751	707
72	—	—	—	—	\$874	831

30 60	—	—	—	—	\$851	807
66	—	—	—	—	\$972	929
72	—	—	—	—	\$1094	1051

36 60	—	—	—	—	\$1076	1033
66	—	—	—	—	\$1205	1162
72	—	—	—	—	\$1333	1289

Step 7.

Top Finish

For laminate top/thermoplastic edge (L)

8Q	folkstone grey	+\$0
91	white	+\$0
98	studio white	+\$0
CL	cool grey neutral	+\$0
HF	inner tone light A	+\$0
HT	inner tone A	+\$0

Peninsula Surface, Round-End,
Transition, Double *continued*

LU	soft white	+\$0
WL	sandstone	+\$0
WN	warm grey neutral	+\$0
76	light brown walnut	+\$0
HM	natural maple	+\$0
HP	light anigre	+\$0
HX	aged cherry	+\$0
HY	walnut on cherry	+\$0
LA	light ash A	+\$0
LBA	clear on ash	+\$0
LBR	phantom ecru	+\$0
LBS	phantom cocoa	+\$0
LBU	medium matte walnut	+\$0
LBV	warm grey teak	+\$0
LBB	oak on ash	+\$0
LBC	walnut on ash	+\$0
LBD	dark brown walnut	+\$0
LBE	medium red walnut	+\$0
OG	honey maple A	+\$0
LBF	neutral twill	+\$0
LBG	sarum twill	+\$0
LBH	earthen twill	+\$0
LBJ	graphite twill	+\$0
LBQ	white twill	+\$0
LBK	pewter mesh	+\$0
LBL	steel mesh	+\$0
LBM	crisp linen	+\$0
LBN	classic linen	+\$0
LBP	casual linen	+\$0

Top/Edge Finish: Wood Veneer
For veneer top/veneer edge (W)

2U	light brown walnut A	+\$85
40	dark brown walnut A	+\$85
ED	aged cherry A	+\$85
EK	medium red walnut A	+\$85
EW	medium matte walnut A	+\$85
ET	clear on ash A	+\$85
EU	oak on ash A	+\$85
EV	walnut on ash A	+\$85
UL	natural maple A	+\$85
UX	walnut on cherry A	+\$85

Top/Edge Finish: Opaque Formcoat®
For painted Formcoat® top/edge (P)

8Q	folkstone grey	+\$0
91	white	+\$0
CL	cool grey neutral	+\$0
LU	soft white	+\$0
WL	sandstone	+\$0
WN	warm grey neutral	+\$0

Step 8. Edge Finish
For laminate top/thermoplastic edge (L)

76	light brown walnut	+\$0
8Q	folkstone grey	+\$0
91	white	+\$0
98	studio white	+\$0
CL	cool grey neutral	+\$0
LA	light ash	+\$0
LBA	clear on ash	+\$0
LBR	phantom ecru	+\$0
LBS	phantom cocoa	+\$0
LBU	medium matte walnut	+\$0
LBV	warm grey teak	+\$0
LBB	oak on ash	+\$0
LBC	walnut on ash	+\$0
LBD	dark brown walnut	+\$0
LBE	medium red walnut	+\$0
LBF	neutral twill	+\$0
LBG	sarum twill	+\$0
LBH	earthen twill	+\$0
LBJ	graphite twill	+\$0
LBK	pewter mesh	+\$0
LBL	steel mesh	+\$0
LBM	crisp linen	+\$0
LBN	classic linen	+\$0
LBP	casual linen	+\$0
LBQ	white twill	+\$0
WL	sandstone	+\$0
WN	warm grey neutral	+\$0
HF	inner tone light	+\$0
HM	natural maple	+\$0
HP	light anigre	+\$0
HT	inner tone	+\$0
HX	aged cherry	+\$0
HY	walnut on cherry	+\$0
LU	soft white	+\$0
OG	honey maple	+\$0

Peninsula Surface, Round-End,
Transition, Double *continued*

Step 9. Bracket Finish

For Canvas frame attachment brackets (F)

91	white	+\$0
CL	cool grey neutral	+\$0
G1	graphite	+\$0
WN	warm grey neutral	+\$0
8Q	folkstone grey	+\$0
98	studio white	+\$0
WL	sandstone	+\$0

Metallic Paint

CN	metallic champagne	+\$0
EH	metallic bronze	+\$0
MS	metallic silver	+\$0

Peninsula Surface, Round-End, Single

FTE61.
FTE62.
FTT61.
FTT62.

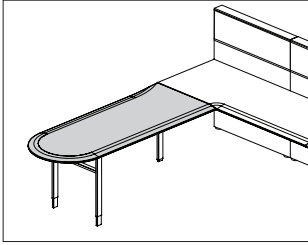

Product Information

Description

This peninsula surface attaches to a single or double transition rectangular surface creating an L- or U-shaped configuration, or is supported by various support components to create a freestanding desk. Thin-edge surfaces have a laminate top and thermoplastic edge, a veneer top and edge, or a painted top and edge. Eased-edge surfaces have a painted top and edge. Laminate and veneer surfaces are 1¹/₄" thick. Painted Formcoat® surfaces are 1" thick.

Notes

For additional product options, see Vary Easy Program in Appendices.

Peninsula surface requires support at both ends of the surface.

To support the peninsula end of the surface, order 1 of the following supports separately:

- Open support leg, architectural foot, peninsula/d-shaped surface attached (FT2A2.A), inset leg position
- Square open support leg, peninsula attached (FV2D1.)
- Support leg, post (FV689.)
- Universal support leg, post (FT2B2.)

For surface attachment bracket (D) option:

- 2 ganging brackets are included for attaching peninsula surface to another surface at 90 degrees.
- Peninsula attaches to the front edge of the rectangular surface transition, single (FTT1A., FTT1B., FTT1C., FTT1D., FTE1A., FTE1B., FTE1C., FTE1D.) or rectangular surface, transition, double (FTT1H., FTT1J., FTT1K., FTE1H., FTE1J., FTE1K.).

For no brackets, for freestanding or use with low credenza (S) option:

Order the following support products separately:

- Support leg, post (FV689.)
- Universal post leg (FT2B2.)

Stiffener (FV696.) is required for any laminate or veneer surface 54" wide or wider and painted formcoat surfaces 48" wide or wider that cannot use a center cantilever. See Canvas Office Landscape Planning Guide for specific stiffener guidelines.

Work surface-attached screens and modesty panels do not work with this peninsula surface.

The open shelf organizer (FF900.) does not work with an eased-edge peninsula surface.

Dimensions

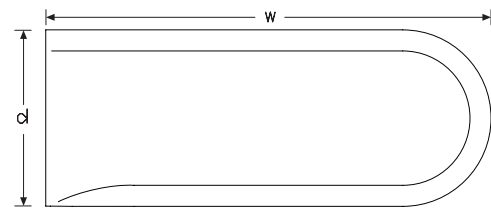

Right

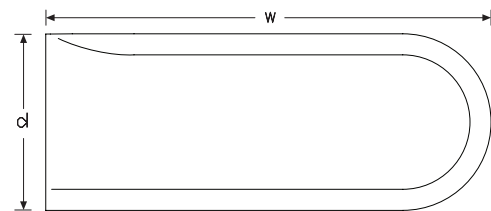

Left

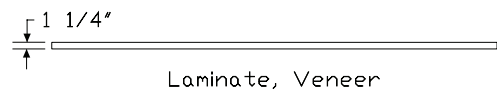

Laminate, Veneer

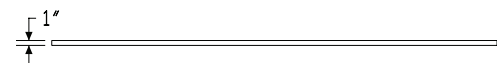

Painted

Peninsula Surface, Round-End,
Single *continued*

Specification Information

Step 1.

FT

Step 2. Edge

T61. thin-edge, right

E61. eased-edge, right

T62. thin-edge, left

E62. eased-edge, left

Step 3. Depth

24 24" deep

30 30" deep

Step 4. Width

48 48" wide

54 54" wide

60 60" wide

66 66" wide

72 72" wide

Step 5. Surface Material

For thin-edge, right (T61.)

L laminate top/thermoplastic edge

W veneer top/veneer edge **A**

P painted Formcoat® top/edge

For thin-edge, left (T62.)

L laminate top/thermoplastic edge

W veneer top/veneer edge **A**

P painted Formcoat® top/edge

For eased-edge, right (E61.)

P painted Formcoat® top/edge

For eased-edge, left (E62.)

P painted Formcoat® top/edge

Step 6. Attachment

D surface attachment bracket

S no brackets, for free standing or use with low credenza

Prices for Steps 1-6.

		LD	LS	WD	WS	PD	PS
FTT61.	24 48	\$411	369	1117	1070	514	471
	54	\$477	436	1267	1219	597	555
	60	\$520	477	1337	1290	651	609
	66	\$611	569	1539	1491	767	726
	72	\$704	662	1740	1693	886	845
	30 48	\$551	510	1410	1363	690	649
	54	\$618	576	1527	1479	777	735
	60	\$686	645	1630	1583	864	822
	66	\$779	737	1799	1753	981	940
	72	\$872	829	1965	1918	1099	1058
FTE61.	24 48	—	—	—	—	\$531	487
	54	—	—	—	—	\$618	574
	60	—	—	—	—	\$673	630
	66	—	—	—	—	\$794	751
	72	—	—	—	—	\$918	874
	30 48	—	—	—	—	\$715	671
	54	—	—	—	—	\$803	760
	60	—	—	—	—	\$894	851
	66	—	—	—	—	\$1016	972
	72	—	—	—	—	\$1138	1094
FTT62.	24 48	\$411	369	1117	1070	514	471
	54	\$477	436	1267	1219	597	555
	60	\$520	477	1337	1290	651	609
	66	\$611	569	1539	1491	767	726
	72	\$704	662	1740	1693	886	845
	30 48	\$551	510	1410	1363	690	649
	54	\$618	576	1527	1479	777	735
	60	\$686	645	1630	1583	864	822
	66	\$779	737	1799	1753	981	940
	72	\$872	829	1965	1918	1099	1058
FTE62.	24 48	—	—	—	—	\$531	487
	54	—	—	—	—	\$618	574
	60	—	—	—	—	\$673	630
	66	—	—	—	—	\$794	751
	72	—	—	—	—	\$918	874
	30 48	—	—	—	—	\$715	671
	54	—	—	—	—	\$803	760
	60	—	—	—	—	\$894	851
	66	—	—	—	—	\$1016	972
	72	—	—	—	—	\$1138	1094

Peninsula Surface, Round-End, Single *continued*

Step 7.

Top Finish

For laminate top/thermoplastic edge (L)

8Q	folkstone grey	+\$0
91	white	+\$0
98	studio white	+\$0
CL	cool grey neutral	+\$0
HF	inner tone light A	+\$0
HT	inner tone A	+\$0
LU	soft white	+\$0
WL	sandstone	+\$0
WN	warm grey neutral	+\$0
76	light brown walnut	+\$0
HM	natural maple	+\$0
HP	light anigre	+\$0
HX	aged cherry	+\$0
HY	walnut on cherry	+\$0
LA	light ash A	+\$0
LBA	clear on ash	+\$0
LBR	phantom ecru	+\$0
LBS	phantom cocoa	+\$0
LBU	medium matte walnut	+\$0
LBV	warm grey teak	+\$0
LBB	oak on ash	+\$0
LBC	walnut on ash	+\$0
LBD	dark brown walnut	+\$0
LBE	medium red walnut	+\$0
OG	honey maple A	+\$0
LBF	neutral twill	+\$0
LBG	sarum twill	+\$0
LBH	earthen twill	+\$0
LBJ	graphite twill	+\$0
LBQ	white twill	+\$0
LBK	pewter mesh	+\$0
LBL	steel mesh	+\$0
LBM	crisp linen	+\$0
LBN	classic linen	+\$0
LBP	casual linen	+\$0

Top/Edge Finish: Wood Veneer

For veneer top/veneer edge (W)

2U	light brown walnut A	+\$85
40	dark brown walnut A	+\$85
ED	aged cherry A	+\$85
EK	medium red walnut A	+\$85
EW	medium matte walnut A	+\$85
ET	clear on ash A	+\$85
EU	oak on ash A	+\$85
EV	walnut on ash A	+\$85
UL	natural maple A	+\$85
UX	walnut on cherry A	+\$85

Top/Edge Finish: Opaque Formcoat®

For painted Formcoat® top/edge (P)

8Q	folkstone grey	+\$0
91	white	+\$0
CL	cool grey neutral	+\$0
LU	soft white	+\$0
WL	sandstone	+\$0
WN	warm grey neutral	+\$0

Step 8. Edge Finish

For laminate top/thermoplastic edge (L)

76	light brown walnut	+\$0
8Q	folkstone grey	+\$0
91	white	+\$0
98	studio white	+\$0
CL	cool grey neutral	+\$0
LA	light ash	+\$0
LBA	clear on ash	+\$0
LBR	phantom ecru	+\$0
LBS	phantom cocoa	+\$0
LBU	medium matte walnut	+\$0
LBV	warm grey teak	+\$0
LBB	oak on ash	+\$0
LBC	walnut on ash	+\$0
LBD	dark brown walnut	+\$0
LBE	medium red walnut	+\$0
LBF	neutral twill	+\$0
LBG	sarum twill	+\$0
LBH	earthen twill	+\$0
LBJ	graphite twill	+\$0
LBK	pewter mesh	+\$0
LBL	steel mesh	+\$0
LBM	crisp linen	+\$0
LBN	classic linen	+\$0

Peninsula Surface, Round-End,
Single *continued*

LBP	casual linen	+\$0
LBQ	white twill	+\$0
WL	sandstone	+\$0
WN	warm grey neutral	+\$0
HF	inner tone light	+\$0
HM	natural maple	+\$0
HP	light anigre	+\$0
HT	inner tone	+\$0
HX	aged cherry	+\$0
HY	walnut on cherry	+\$0
LU	soft white	+\$0
OG	honey maple	+\$0

Peninsula Surface, Round-End,
Center

FTE60.
FTT60.

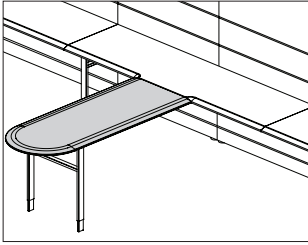

Product Information

Description

This peninsula surface attaches to a rectangular surface, transition, center or is supported by various support components to create a freestanding desk. Thin-edge surfaces have a laminate top and thermoplastic edge, a veneer top and edge, or a painted top and edge. Eased-edge surfaces have a painted top and edge. Laminate and veneer surfaces are 1 1/4" thick. Painted Formcoat® surfaces are 1" thick.

Notes

For additional product options, see Vary Easy Program in Appendices.

Peninsula surface requires support at both ends of the surface.

To support the peninsula end of the surface, order 1 of the following supports separately:

- Open support leg, architectural foot, peninsula/d-shaped surface attached (FT2A2.A), inset leg position.
- Square open support leg, peninsula attached (FV2D1.)
- Support leg, post (FV689.)
- Universal support leg, post (FT2B2.)

For surface attachment bracket (D) option:

- 2 ganging brackets are included for attaching peninsula surface to another surface at 90 degrees.
- Peninsula surface attaches to the front edge of the rectangular surface, transition, center (FTT1E., FTT1F., FTT1G., FTE1E., FTE1F., FTE1G.).

For no brackets, for freestanding or use with low credenza (S) option:

Order the following support products separately:

- Support leg, post (FV689.)
- Universal post leg (FT2B2.)

Stiffener (FV696.) is required for any laminate or veneer surface 54" wide or wider and painted formcoat surfaces 48" wide or wider that cannot use a center cantilever. See Canvas Office Landscape® Planning Guide for specific stiffener guidelines.

Work surface-attached screens and modesty panels do not work with this peninsula surface.

The open shelf organizer (FF900.) does not work with the eased edge peninsula surface.

Dimensions

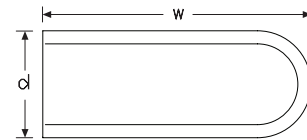

D or S

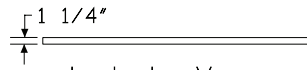

Laminate, Veneer

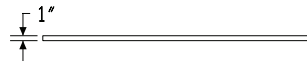

Painted

Peninsula Surface, Round-End,
Center *continued*

Specification Information

Step 1.

FT

Step 2. Edge

T60. thin-edge

E60. eased-edge

Step 3. Depth

24 24" deep

30 30" deep

36 36" deep

Step 4. Width

48 48" wide

54 54" wide

60 60" wide

66 66" wide

72 72" wide

Step 5. Surface Material

For thin-edge (T60.)

L laminate top/thermoplastic edge

W veneer top/veneer edge **A**

P painted Formcoat® top/edge

For eased-edge (E60.)

P painted Formcoat® top/edge

Step 6. Attachment

D surface attachment bracket

S no brackets, for free standing or use with low credenza

Prices for Steps 1-6.

	LD	LS	WD	WS	PD	PS
FTT60. 24 48	\$411	369	1117	1070	514	471
54	\$477	436	1267	1219	597	555
60	\$520	477	1337	1290	651	609
66	\$611	569	1539	1491	767	726
72	\$704	662	1740	1693	886	845
30 48	\$551	510	1410	1363	690	649
54	\$618	576	1527	1479	777	735
60	\$686	645	1630	1583	864	822
66	\$779	737	1799	1753	981	940
72	\$872	829	1965	1918	1099	1058

36 48	\$726	683	1687	1641	915	872
54	\$804	762	1792	1746	1015	972
60	\$858	816	1833	1786	1083	1041
66	\$956	915	1975	1929	1207	1165
72	\$1052	1010	2111	2064	1330	1288
FTE60. 24 48	—	—	—	—	\$536	492
54	—	—	—	—	\$624	580
60	—	—	—	—	\$680	636
66	—	—	—	—	\$802	758
72	—	—	—	—	\$927	883
30 48	—	—	—	—	\$722	678
54	—	—	—	—	\$811	768
60	—	—	—	—	\$903	859
66	—	—	—	—	\$1026	982
72	—	—	—	—	\$1149	1105
36 48	—	—	—	—	\$954	910
54	—	—	—	—	\$1060	1016
60	—	—	—	—	\$1132	1087
66	—	—	—	—	\$1261	1217
72	—	—	—	—	\$1390	1346

Step 7.

Top Finish

For laminate top/thermoplastic edge (L)

8Q	folkstone grey	+\$0
91	white	+\$0
98	studio white	+\$0
CL	cool grey neutral	+\$0
HF	inner tone light A	+\$0
HT	inner tone A	+\$0
LU	soft white	+\$0
WL	sandstone	+\$0
WN	warm grey neutral	+\$0
76	light brown walnut	+\$0
HM	natural maple	+\$0
HP	light anigre	+\$0
HX	aged cherry	+\$0
HY	walnut on cherry	+\$0
LA	light ash A	+\$0
LBA	clear on ash	+\$0
LBR	phantom ecru	+\$0
LBS	phantom cocoa	+\$0
LBU	medium matte walnut	+\$0
LBV	warm grey teak	+\$0
LBB	oak on ash	+\$0

Peninsula Surface, Round-End, Center *continued*

LBC	walnut on ash	+\$0
LBD	dark brown walnut	+\$0
LBE	medium red walnut	+\$0
OG	honey maple <input type="checkbox"/> A	+\$0
LBF	neutral twill	+\$0
LBG	sarum twill	+\$0
LBH	earthen twill	+\$0
LBJ	graphite twill	+\$0
LBQ	white twill	+\$0
LBK	pewter mesh	+\$0
LBL	steel mesh	+\$0
LBM	crisp linen	+\$0
LBN	classic linen	+\$0
LBP	casual linen	+\$0

Top/Edge Finish: Wood Veneer

For veneer top/veneer edge (W)

2U	light brown walnut <input type="checkbox"/> A	+\$85
40	dark brown walnut <input type="checkbox"/> A	+\$85
ED	aged cherry <input type="checkbox"/> A	+\$85
EK	medium red walnut <input type="checkbox"/> A	+\$85
EW	medium matte walnut <input type="checkbox"/> A	+\$85
ET	clear on ash <input type="checkbox"/> A	+\$85
EU	oak on ash <input type="checkbox"/> A	+\$85
EV	walnut on ash <input type="checkbox"/> A	+\$85
UL	natural maple <input type="checkbox"/> A	+\$85
UX	walnut on cherry <input type="checkbox"/> A	+\$85

Top/Edge Finish: Opaque Formcoat®

For painted Formcoat® top/edge (P)

8Q	folkstone grey	+\$0
91	white	+\$0
CL	cool grey neutral	+\$0
LU	soft white	+\$0
WL	sandstone	+\$0
WN	warm grey neutral	+\$0

Step 8. Edge Finish

For laminate top/thermoplastic edge (L)

76	light brown walnut	+\$0
8Q	folkstone grey	+\$0
91	white	+\$0
98	studio white	+\$0
CL	cool grey neutral	+\$0
LA	light ash	+\$0
LBA	clear on ash	+\$0
LBR	phantom ecru	+\$0

LBS	phantom cocoa	+\$0
LBU	medium matte walnut	+\$0
LBV	warm grey teak	+\$0
LBB	oak on ash	+\$0
LBC	walnut on ash	+\$0
LBD	dark brown walnut	+\$0
LBE	medium red walnut	+\$0
LBF	neutral twill	+\$0
LBG	sarum twill	+\$0
LBH	earthen twill	+\$0
LBJ	graphite twill	+\$0
LBK	pewter mesh	+\$0
LBL	steel mesh	+\$0
LBM	crisp linen	+\$0
LBN	classic linen	+\$0
LBP	casual linen	+\$0
LBQ	white twill	+\$0
WL	sandstone	+\$0
WN	warm grey neutral	+\$0
HF	inner tone light	+\$0
HM	natural maple	+\$0
HP	light anigre	+\$0
HT	inner tone	+\$0
HX	aged cherry	+\$0
HY	walnut on cherry	+\$0
LU	soft white	+\$0
OG	honey maple	+\$0

D-Shaped Surface

FTE36.
FTS36.
FTT36.

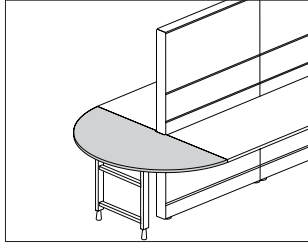

Product Information

Description

This surface attaches to the ends of 2 surfaces separated by a frame. It has a laminate top and thermoplastic edge, a veneer top and edge, or a painted top and edge. Laminate and veneer surfaces are 1 1/4" thick. Painted Formcoat® surfaces are 1" thick. The surface cannot stand alone. Brackets are included for attaching the d-shaped surface to adjacent surfaces.

Notes

For additional size, shape, cable management, and finish options, see Vary Easy Program in Appendices.

51"-wide d-shaped surface attaches to 24"-deep surfaces at the end of a frame. 63"-wide d-shaped surface attaches to 30"-deep surfaces at the end of a frame. The surface is notched to allow a flush fit against the finished end.

To support the end of the surface, order 1 of the following supports separately:

- Open support leg, tapered foot, peninsula/d-shaped surface attached (FT2F2.)
- Open support leg, architectural foot, peninsula/d-shaped surface attached (FT2A2.)

Or order 2 of the following supports separately:

- Support leg, post (FV689.)
- Universal support leg, post (FT2B2.)

Dimensions

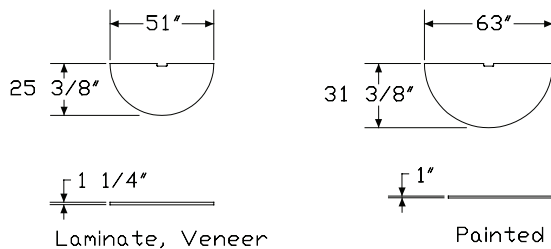

Specification Information

Step 1.

FT

Step 2. Edge

- S36.** squared-edge
- T36.** thin-edge
- E36.** eased-edge

Step 3. Width

- 51** 51" wide
- 63** 63" wide

Step 4. Surface Material

For squared-edge (S36.)

- L** laminate top/thermoplastic edge
- W** veneer top/veneer edge **A**
- P** painted Formcoat® top/edge

For thin-edge (T36.)

- L** laminate top/thermoplastic edge
- W** veneer top/veneer edge **A**
- P** painted Formcoat® top/edge

For eased-edge (E36.)

- P** painted Formcoat® top/edge

Step 5. Attachment

- D** surface attachment bracket

Prices for Steps 1-5.

		D
FTE36.	51 L	\$443
	W	\$725
	P	\$510
	63 L	\$523
	W	\$1150
	P	\$601
		D
FTT36.	51 L	\$589
	W	\$827
	P	\$518
	63 L	\$725
	W	\$1367
	P	\$635

D-Shaped Surface *continued*

		D
FTE36. 51 P		\$523
63 P		\$641
Step 6.		
Top Finish		
<i>For laminate top/thermoplastic edge (L)</i>		
8Q	folkstone grey	+\$0
91	white	+\$0
98	studio white	+\$0
CL	cool grey neutral	+\$0
HF	inner tone light A	+\$0
HT	inner tone A	+\$0
LU	soft white	+\$0
WL	sandstone	+\$0
WN	warm grey neutral	+\$0
76	light brown walnut	+\$0
HM	natural maple	+\$0
HP	light anigre	+\$0
HX	aged cherry	+\$0
HY	walnut on cherry	+\$0
LA	light ash A	+\$0
LBA	clear on ash	+\$0
LBR	phantom ecru	+\$0
LBS	phantom cocoa	+\$0
LBU	medium matte walnut	+\$0
LBV	warm grey teak	+\$0
LBB	oak on ash	+\$0
LBC	walnut on ash	+\$0
LBD	dark brown walnut	+\$0
LBE	medium red walnut	+\$0
OG	honey maple A	+\$0
LBF	neutral twill	+\$0
LBG	sarum twill	+\$0
LBH	earthen twill	+\$0
LBJ	graphite twill	+\$0
LBQ	white twill	+\$0
LBK	pewter mesh	+\$0
LBL	steel mesh	+\$0
LBM	crisp linen	+\$0
LBN	classic linen	+\$0
LBP	casual linen	+\$0

Top/Edge Finish: Wood Veneer		
<i>For veneer top/veneer edge (W)</i>		
2U	light brown walnut A	+\$85
40	dark brown walnut A	+\$85
ED	aged cherry A	+\$85
EK	medium red walnut A	+\$85
EW	medium matte walnut A	+\$85
ET	clear on ash A	+\$85
EU	oak on ash A	+\$85
EV	walnut on ash A	+\$85
UL	natural maple A	+\$85
UX	walnut on cherry A	+\$85

Top/Edge Finish: Opaque Formcoat®		
<i>For painted Formcoat® top/edge (P)</i>		
8Q	folkstone grey	+\$0
91	white	+\$0
CL	cool grey neutral	+\$0
LU	soft white	+\$0
WL	sandstone	+\$0
WN	warm grey neutral	+\$0

Step 7. Edge Finish		
<i>For laminate top/thermoplastic edge (L)</i>		
76	light brown walnut	+\$0
8Q	folkstone grey	+\$0
91	white	+\$0
98	studio white	+\$0
CL	cool grey neutral	+\$0
LA	light ash	+\$0
LBA	clear on ash	+\$0
LBR	phantom ecru	+\$0
LBS	phantom cocoa	+\$0
LBU	medium matte walnut	+\$0
LBV	warm grey teak	+\$0
LBB	oak on ash	+\$0
LBC	walnut on ash	+\$0
LBD	dark brown walnut	+\$0
LBE	medium red walnut	+\$0
LBF	neutral twill	+\$0
LBG	sarum twill	+\$0
LBH	earthen twill	+\$0
LBJ	graphite twill	+\$0
LBK	pewter mesh	+\$0
LBL	steel mesh	+\$0
LBM	crisp linen	+\$0
LBN	classic linen	+\$0

D-Shaped Surface *continued*

LBP	casual linen	+\$0
LBQ	white twill	+\$0
WL	sandstone	+\$0
WN	warm grey neutral	+\$0
HF	inner tone light	+\$0
HM	natural maple	+\$0
HP	light anigre	+\$0
HT	inner tone	+\$0
HX	aged cherry	+\$0
HY	walnut on cherry	+\$0
LU	soft white	+\$0
OG	honey maple	+\$0

About Face™ Bridge Surface

FTE15.
FTS15.
FTT15.

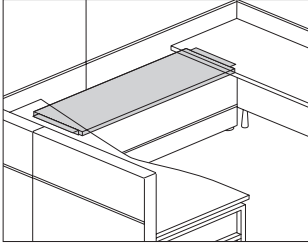

Canvas Office Landscape® Work Surfaces

Product Information

Description
This bridge attaches below 2 surfaces to provide additional surface area along the spine wall. The surface has a laminate top and thermoplastic edge, laminate top with a thermoplastic backed plywood edge, veneer top and edge, or painted top and edge. Laminate and veneer surfaces are 1/4" thick. Painted Formcoat® surfaces are 1" thick. Attachment hardware and center support bracket are included.

Notes

For additional size, shape, cable management, and finish options, see Vary Easy Program in Appendices.
Bridge mounts in 3 positions, from 3"-5" below the surface in 1" increments.
Specify 60"-wide bridge for 6'-wide workstation.
Specify 72"-wide bridge for 7'-wide workstation.
Specify 84"-wide bridge for 8'-wide workstation.

Dimensions

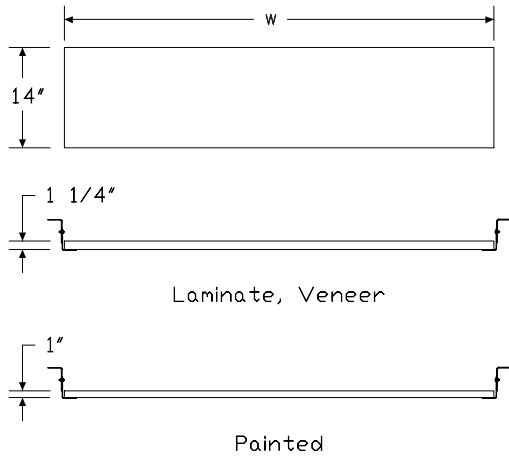

Specification Information

Step 1.

FT

Step 2. Edge

S15. squared-edge
T15. thin-edge
E15. eased-edge

Step 3. Depth

15 15" deep

Step 4. Width

60 60" wide
72 72" wide
84 84" wide

Step 5. Surface Material

For squared-edge (S15.)

L laminate top/thermoplastic edge
W veneer top/veneer edge **A**
P painted Formcoat® top/edge

For thin-edge (T15.)

L laminate top/thermoplastic edge
W veneer top/veneer edge **A**
P painted Formcoat® top/edge

For eased-edge (E15.)

P painted Formcoat® top/edge

Step 6. Attachment

F Canvas frame attached surface

Prices for Steps 1-6.

			LF	WF	PF
FTS15.	15	60	\$403	772	466
		72	\$484	921	557
		84	\$553	1069	637
FTT15.	15	60	\$559	918	489
		72	\$671	1094	588
		84	\$767	1271	671

About Face™ Bridge Surface

continued

FTE15. 15 60	—	—	\$489
72	—	—	\$588
84	—	—	\$671

Step 7.

Top Finish

For laminate top/thermoplastic edge (L)

8Q	folkstone grey	+\$0
91	white	+\$0
98	studio white	+\$0
CL	cool grey neutral	+\$0
HF	inner tone light A	+\$0
HT	inner tone A	+\$0
LU	soft white	+\$0
WL	sandstone	+\$0
WN	warm grey neutral	+\$0
76	light brown walnut	+\$0
HM	natural maple	+\$0
HP	light anigre	+\$0
HX	aged cherry	+\$0
HY	walnut on cherry	+\$0
LA	light ash A	+\$0
LBA	clear on ash	+\$0
LBR	phantom ecru	+\$0
LBS	phantom cocoa	+\$0
LBU	medium matte walnut	+\$0
LBV	warm grey teak	+\$0
LBB	oak on ash	+\$0
LBC	walnut on ash	+\$0
LBD	dark brown walnut	+\$0
LBE	medium red walnut	+\$0
OG	honey maple A	+\$0
LBF	neutral twill	+\$0
LBG	sarum twill	+\$0
LBH	earthen twill	+\$0
LBJ	graphite twill	+\$0
LBQ	white twill	+\$0
LBK	pewter mesh	+\$0
LBL	steel mesh	+\$0
LBM	crisp linen	+\$0
LBN	classic linen	+\$0
LBP	casual linen	+\$0

Top/Edge Finish: Wood Veneer

For veneer top/veneer edge (W)

2U	light brown walnut A	+\$85
40	dark brown walnut A	+\$85
ED	aged cherry A	+\$85
EK	medium red walnut A	+\$85
EW	medium matte walnut A	+\$85
ET	clear on ash A	+\$85
EU	oak on ash A	+\$85
EV	walnut on ash A	+\$85
UL	natural maple A	+\$85
UX	walnut on cherry A	+\$85

Top/Edge Finish: Opaque Formcoat®

For painted Formcoat® top/edge (P)

8Q	folkstone grey	+\$0
91	white	+\$0
CL	cool grey neutral	+\$0
LU	soft white	+\$0
WL	sandstone	+\$0
WN	warm grey neutral	+\$0

Step 8. Edge Finish

For laminate top/thermoplastic edge (L)

76	light brown walnut	+\$0
8Q	folkstone grey	+\$0
91	white	+\$0
98	studio white	+\$0
CL	cool grey neutral	+\$0
LA	light ash	+\$0
LBA	clear on ash	+\$0
LBR	phantom ecru	+\$0
LBS	phantom cocoa	+\$0
LBU	medium matte walnut	+\$0
LBV	warm grey teak	+\$0
LBB	oak on ash	+\$0
LBC	walnut on ash	+\$0
LBD	dark brown walnut	+\$0
LBE	medium red walnut	+\$0
LBF	neutral twill	+\$0
LBG	sarum twill	+\$0
LBH	earthen twill	+\$0
LBJ	graphite twill	+\$0
LBK	pewter mesh	+\$0
LBL	steel mesh	+\$0
LBM	crisp linen	+\$0
LBN	classic linen	+\$0

About Face™ Bridge Surface

continued

Canvas Office Landscape® Work Surfaces

LBP	casual linen	+\$0
LBQ	white twill	+\$0
WL	sandstone	+\$0
WN	warm grey neutral	+\$0
HF	inner tone light	+\$0
HM	natural maple	+\$0
HP	light anigre	+\$0
HT	inner tone	+\$0
HX	aged cherry	+\$0
HY	walnut on cherry	+\$0
LU	soft white	+\$0
OG	honey maple	+\$0

Squared-Edge Corner Wedge

Y2091.

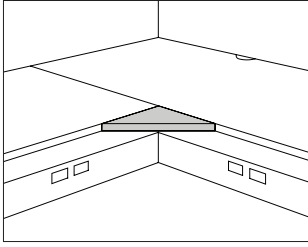

Product Information

Description

This wedge attaches to 2 work surfaces at a 90° angle to provide a corner work surface. It can be used with Action Office®, Canvas, and Ethospace® surfaces. The wedge has a laminate top and thermoplastic edge, laminate top with a thermoplastic backed plywood edge, or a veneer top and edge. Attachment hardware is included.

Notes

Corner wedge can support a keyboard tray attached to the underside of the work surfaces in 90° corner applications.

Dimensions

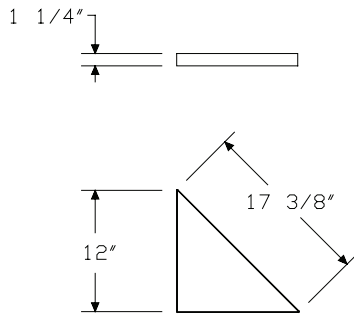

Specification Information

Step 1.

Y2091.

Step 2. Surface Material

- L** laminate top/thermoplastic edge
- U** laminate top/universal edge
- W** veneer A

Prices for Steps 1-2.

Y2091. L	\$113
U	\$110
W	\$164

Step 3.

Top Finish

For laminate top/thermoplastic edge (L) or laminate top/universal edge (U)

76	light brown walnut	+\$0
8Q	folkstone grey	+\$0
91	white	+\$0
98	studio white	+\$0
CL	cool grey neutral	+\$0
HF	inner tone light	+\$0
HM	natural maple	+\$0
HP	light anigre	+\$0
HT	inner tone	+\$0
HX	aged cherry	+\$0
HY	walnut on cherry	+\$0
LA	light ash	+\$0
LBA	clear on ash	+\$0
LBR	phantom ecru	+\$0
LBS	phantom cocoa	+\$0
LBU	medium matte walnut	+\$0
LBV	warm grey teak	+\$0
LBB	oak on ash	+\$0
LBC	walnut on ash	+\$0
LBD	dark brown walnut	+\$0
LBE	medium red walnut	+\$0
LBF	neutral twill	+\$0
LBG	sarum twill	+\$0
LBH	earthen twill	+\$0
LBJ	graphite twill	+\$0
LBK	pewter mesh	+\$0
LBL	steel mesh	+\$0
LBM	crisp linen	+\$0

Squared-Edge Corner Wedge

continued

Canvas Office Landscape® Work Surfaces

LBN	classic linen	+\$0
LBP	casual linen	+\$0
LBQ	white twill	+\$0
LM	mahogany	+\$0
LT	light tone	+\$0
LU	soft white	+\$0
MT	medium tone	+\$0
WL	sandstone	+\$0
WN	warm grey neutral	+\$0

Top/Edge Finish: Recut Veneer

For veneer (W)

RA	light ash A	+\$0
RK	mahogany dark A	+\$0
RM	mahogany A	+\$0
XU	cathedral recut medium red cherry A	+\$39

Top/Edge Finish: Wood Veneer

For veneer (W)

2U	light brown walnut A	+\$39
40	dark brown walnut A	+\$39
ED	aged cherry A	+\$39
EK	medium red walnut A	+\$39
EW	medium matte walnut A	+\$39
ET	clear on ash A	+\$39
EU	oak on ash A	+\$39
EV	walnut on ash A	+\$39
UL	natural maple A	+\$39
UX	walnut on cherry A	+\$39

Step 4. Edge Finish

For laminate top/thermoplastic edge (L)

76	light brown walnut	+\$0
8Q	folkstone grey	+\$0
8Z	neutral grey	+\$0
91	white	+\$0
98	studio white	+\$0
BU	black umber	+\$0
CL	cool grey neutral	+\$0
HF	inner tone light	+\$0
HM	natural maple	+\$0
HP	light anigre	+\$0
HT	inner tone	+\$0
HX	aged cherry	+\$0
HY	walnut on cherry	+\$0
JB	millwork cherry	+\$0

LA	light ash	+\$0
LBA	clear on ash	+\$0
LBR	phantom ecru	+\$0
LBS	phantom cocoa	+\$0
LBU	medium matte walnut	+\$0
LBV	warm grey teak	+\$0
LBB	oak on ash	+\$0
LBC	walnut on ash	+\$0
LBD	dark brown walnut	+\$0
LBE	medium red walnut	+\$0
LBF	neutral twill	+\$0
LBG	sarum twill	+\$0
LBH	earthen twill	+\$0
LBJ	graphite twill	+\$0
LBK	pewter mesh	+\$0
LBL	steel mesh	+\$0
LBM	crisp linen	+\$0
LBN	classic linen	+\$0
LBP	casual linen	+\$0
LBQ	white twill	+\$0
LU	soft white	+\$0
MT	medium tone	+\$0
WL	sandstone	+\$0
WN	warm grey neutral	+\$0

For laminate top/universal edge (U)

PLY	plywood edge	+\$50
------------	--------------	-------

Squared-Edge Transaction Surface

FT280.

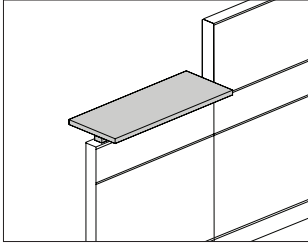

Product Information

Description

This 14"-deep rectangular surface attaches to the top of a frame and provides a counter or display surface. It has a laminate top with thermoplastic edge, laminate top with a thermoplastic backed plywood edge, or veneer top and edge. Stanchions attach the surface to the frame; a painted or veneer top cap with cutouts is included to accommodate the stanchions. The top of the surface sits 39" above the floor when used on a 35"-high frame. Attachment hardware is included.

Transaction surfaces wider than 48" require multiple frames:

Width—Frames

60" —any combination of frames totaling 60"

72" —any combination of frames totaling 72"

84" —2 42"-wide frames

96" —2 48"-wide frames

Notes

Transaction surface should be used with 35"-high frame.

Transaction surface cannot be used with change-of-height finished end with cable routing capability (FT161.B).

When placing 2 transaction surfaces side-by-side, there will be a .875" gap between surfaces.

Gap from frame top cap to underside of surface is 3.125".

Dimensions

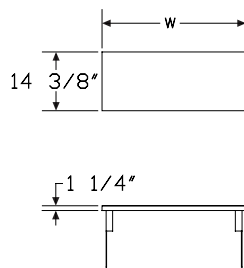

Specification Information

Step 1.

FT280.

Step 2. Width

24	24" wide
30	30" wide
36	36" wide
42	42" wide
48	48" wide
60	60" wide
72	72" wide
84	84" wide
96	96" wide

Step 3. Surface Material

L	laminate top/thermoplastic edge
W	veneer A
U	laminate top/universal edge A

Step 4. Top Cap Material

P	painted standard top cap
W	veneer standard top cap A
A	painted architectural top cap

Prices for Steps 1-4.

		P	W	A
FT280. 24	L	\$542	722	656
	W	\$816	996	928
	U	\$542	722	656
30	L	\$560	779	689
	W	\$878	1097	1008
	U	\$560	779	689
36	L	\$578	832	722
	W	\$942	1195	1086
	U	\$578	832	722
42	L	\$596	886	759
	W	\$1005	1296	1168
	U	\$596	886	759
48	L	\$616	942	794
	W	\$1069	1396	1248
	U	\$616	942	794
60	L	\$924	1323	1134
	W	\$1469	1869	1682
	U	\$924	1323	1134

Squared-Edge Transaction Surface *continued*

Canvas Office Landscape® Work Surfaces

72 L	\$959	1469	1205
W	\$1598	2107	1842
U	\$959	1469	1205
84 L	\$996	1578	1276
W	\$1726	2305	2004
U	\$996	1578	1276
96 L	\$1032	1689	1378
W	\$1853	2508	2195
U	\$1032	1689	1378

Step 5.

Top Finish

For laminate top/thermoplastic edge (L) or laminate top/universal edge (U)

8Q	folkstone grey	+\$0
91	white	+\$0
98	studio white	+\$0
CL	cool grey neutral	+\$0
HF	inner tone light A	+\$0
HT	inner tone A	+\$0
LU	soft white	+\$0
WL	sandstone	+\$0
WN	warm grey neutral	+\$0
76	light brown walnut	+\$0
HM	natural maple	+\$0
HP	light anigre	+\$0
HX	aged cherry	+\$0
HY	walnut on cherry	+\$0
LA	light ash A	+\$0
LBA	clear on ash	+\$0
LBR	phantom ecru	+\$0
LBS	phantom cocoa	+\$0
LBU	medium matte walnut	+\$0
LBV	warm grey teak	+\$0
LBB	oak on ash	+\$0
LBC	walnut on ash	+\$0
LBD	dark brown walnut	+\$0
LBE	medium red walnut	+\$0
LBF	neutral twill	+\$0
LBG	sarum twill	+\$0
LBH	earthen twill	+\$0
LBJ	graphite twill	+\$0
LBQ	white twill	+\$0
LBK	pewter mesh	+\$0
LBL	steel mesh	+\$0
LBM	crisp linen	+\$0
LBN	classic linen	+\$0
LBP	casual linen	+\$0

Squared-Edge Transaction

Surface *continued*

Top/Edge Finish: Wood Veneer

For veneer (W)

2U	light brown walnut A	+\$60
40	dark brown walnut A	+\$60
ED	aged cherry A	+\$60
EK	medium red walnut A	+\$60
EW	medium matte walnut A	+\$60
ET	clear on ash A	+\$60
EU	oak on ash A	+\$60
EV	walnut on ash A	+\$60
UL	natural maple A	+\$60
UX	walnut on cherry A	+\$60

Step 6. Edge Finish

For laminate top/thermoplastic edge (L)

76	light brown walnut	+\$0
8Q	folkstone grey	+\$0
91	white	+\$0
98	studio white	+\$0
CL	cool grey neutral	+\$0
LA	light ash	+\$0
LBA	clear on ash	+\$0
LBR	phantom ecru	+\$0
LBS	phantom cocoa	+\$0
LBU	medium matte walnut	+\$0
LBV	warm grey teak	+\$0
LBB	oak on ash	+\$0
LBC	walnut on ash	+\$0
LBD	dark brown walnut	+\$0
LBE	medium red walnut	+\$0
LBF	neutral twill	+\$0
LBG	sarum twill	+\$0
LBH	earthen twill	+\$0
LBJ	graphite twill	+\$0
LBK	pewter mesh	+\$0
LBL	steel mesh	+\$0
LBM	crisp linen	+\$0
LBN	classic linen	+\$0
LBP	casual linen	+\$0
LBQ	white twill	+\$0
WL	sandstone	+\$0
WN	warm grey neutral	+\$0
HF	inner tone light	+\$0
HM	natural maple	+\$0
HP	light anigre	+\$0
HT	inner tone	+\$0
HX	aged cherry	+\$0
HY	walnut on cherry	+\$0
LU	soft white	+\$0

For laminate top/universal edge (U)

PLY	plywood edge A	+\$50
------------	--	-------

Step 7. Top Cap Finish

For painted standard top cap (P) or painted architectural top cap (A)

8Q	folkstone grey	+\$0
98	studio white	+\$0
WL	sandstone	+\$0

Squared-Edge Transaction Surface *continued*

Bright Sand Texture Paint
For painted standard top cap (P) or painted architectural top cap (A)

91	white	+\$0
CL	cool grey neutral	+\$0
G1	graphite	+\$0
WN	warm grey neutral	+\$0

Metallic Paint
For painted standard top cap (P) or painted architectural top cap (A)

CN	metallic champagne	+\$0
EH	metallic bronze	+\$0
MS	metallic silver	+\$0

Wood Veneer
For veneer standard top cap (W)

2U	light brown walnut <input type="checkbox"/> A	+\$0
40	dark brown walnut	+\$0
ED	aged cherry <input type="checkbox"/> A	+\$0
EK	medium red walnut	+\$0
EW	medium matte walnut	+\$0
ET	clear on ash <input type="checkbox"/> A	+\$0
EU	oak on ash <input type="checkbox"/> A	+\$0
EV	walnut on ash <input type="checkbox"/> A	+\$0
UL	natural maple <input type="checkbox"/> A	+\$0
UX	walnut on cherry <input type="checkbox"/> A	+\$0

Step 8. Stanchion Finish

8Q	folkstone grey	+\$0
98	studio white	+\$0
WL	sandstone	+\$0

Bright Sand Texture Paint

91	white	+\$0
CL	cool grey neutral	+\$0
G1	graphite	+\$0
WN	warm grey neutral	+\$0

Metallic Paint

CN	metallic champagne	+\$0
EH	metallic bronze	+\$0
MS	metallic silver	+\$0

Step 9. Application

LD	stacking on 35", 46", 57", 68", 79" base frame	+\$0
JL	stacking on 42"-high base frame	+\$40

Surface Cantilever

FT290.

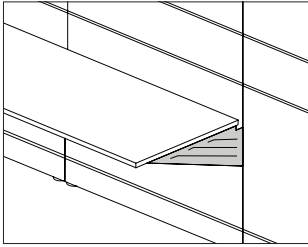

Product Information

Description

This bracket supports a surface on the left or right side and attaches the surface to a frame or wall strips. Attachment hardware and 1 surface cantilever are included.

Notes

Specify cantilever depth to match depth of surface being supported. Cantilevered surfaces can be placed in 1" vertical increments along the frame or wall strips.

Dimensions

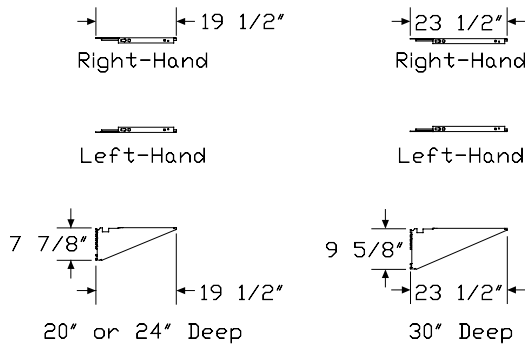

Specification Information

Step 1.

FT290.

Step 2. Surface Depth

- 24** for 20"- or 24"-deep surfaces
- 30** for 30"-deep surface

Step 3. Position

- L** left-hand cantilever
- R** right-hand cantilever

Prices for Steps 1-3.

	L	R
FT290. 24	\$34	34
30	\$40	40

Step 4. Finish

8Q	folkstone grey A	+\$0
98	studio white A	+\$0
WL	sandstone A	+\$0

Reclaimed Paint

RS	ironstone	-\$5
-----------	-----------	------

Bright Sand Texture Paint

91	white	+\$0
CL	cool grey neutral	+\$0
G1	graphite	+\$0
WN	warm grey neutral	+\$0

Metallic Paint

CN	metallic champagne	+\$0
EH	metallic bronze	+\$0
MS	metallic silver	+\$0

Surface Ganging Bracket

FT29B.

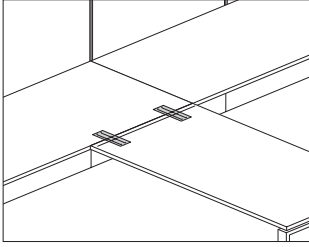

Canvas Office Landscape® Work Surfaces

Product Information

Description

This bracket connects one side of a square-edge surface to another square-edge surface in line or at a right angle.

Notes

For freestanding surface applications, when attaching 2 rectangular surfaces perpendicular to each other or when attaching a rectangular surface perpendicular to the squared-edge portion of a rectangular transition surface specify the pair version (FT29B.2).

When attaching freestanding surfaces next to each other in a straight line with a shared leg supporting the back portion of the surfaces, specify the single version (FT29B.1).

Dimensions

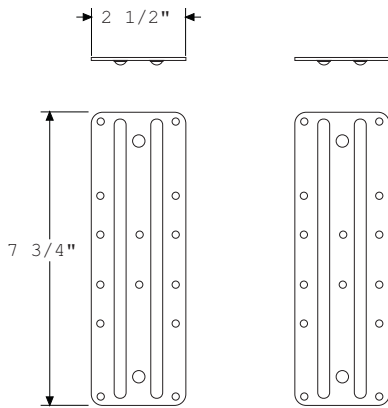

Specification Information

Step 1.

FT29B.

Step 2. Type

- 1 single
- 2 pair

Prices for Steps 1-2.

FT29B. 1	\$22
2	\$42

Peninsula Support Bracket

FT29A.

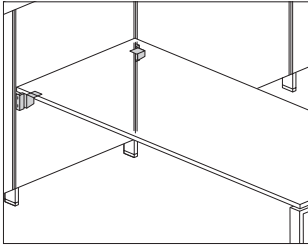

Product Information

Description

This support bracket attaches one end of a square edge rectangular surface perpendicular to a frame or wall strips to form a peninsula application. Package contains 1 pair.

Notes

Match depth of surface to width of frame.

Peninsula support brackets only attach to the squared-edge portion of a surface.

Dimensions

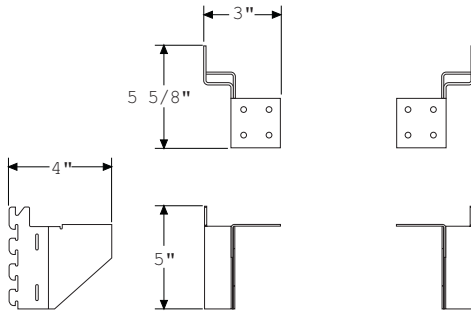

Specification Information

Step 1.

FT29A. \$188

Step 2. Finish

8Q	folkstone grey	+\$0
98	studio white	+\$0
WL	sandstone	+\$0
CL	cool grey neutral	+\$0
G1	graphite	+\$0
WN	warm grey neutral	+\$0
91	white	+\$0
CN	metallic champagne	+\$0
EH	metallic bronze	+\$0
MS	metallic silver	+\$0

Work Surface Support Bracket

E2931.

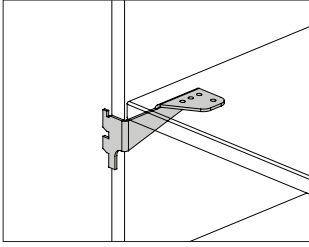

Canvas Office Landscape® Work Surfaces

Product Information

Description

This bracket attaches to the front corner of an Ethospace® or Canvas hanging work surface to provide support. It can be used only when the return frame width matches the work surface depth. The bracket cannot be used with an Ethospace Flex-Edge™ work surface. Package contains 4.

Dimensions

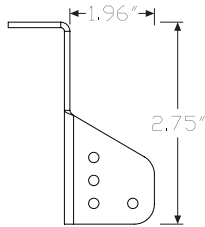
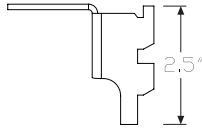

Specification Information

Step 1.

E2931.

Step 2. Position

L left

R right

Prices for Steps 1-2.

E2931. L	\$61
R	\$61

Step 3. Finish

8Q	folkstone grey	+\$0
91	white	+\$0
98	studio white A	+\$0
BU	black umber	+\$0
HF	inner tone light	+\$0
LU	soft white	+\$0
MT	medium tone	+\$0
SG	slate grey	+\$0
WL	sandstone	+\$0
CN	metallic champagne	+\$0
MS	metallic silver	+\$0

Surface Support Rail

FT295.

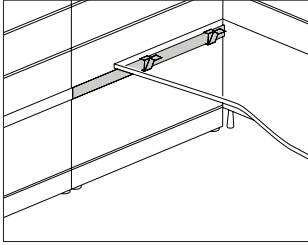

Product Information

Description

This rail attaches to an equal-width frame and provides support for the depth of a frame-attached surface. The rail also holds work tools.

Notes

Specify width of support rail to match width of frame.

When surface is placed at $28\frac{1}{2}$ " , top of support rail is $27\frac{1}{4}$ " .

The opposite end of the surface can be supported by another frame and support rail or a frame-attached support panel or frame-attached open support of equal depth.

Surface support rail will not support a peninsula surface.

Dimensions

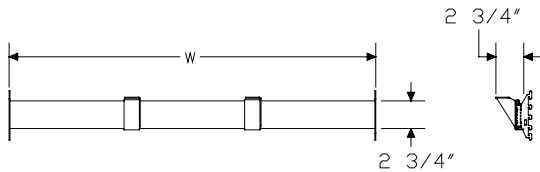

Specification Information

Step 1.

FT295.

Step 2. Frame Width

24	24" wide
30	30" wide
36	36" wide
42	42" wide
48	48" wide

Prices for Steps 1-2.

FT295. 24	\$86
30	\$101
36	\$113
42	\$124
48	\$131

Step 3. Finish

8Q	folkstone grey <input type="checkbox"/> A	+\$0
91	white	+\$0
98	studio white <input type="checkbox"/> A	+\$0
CL	cool grey neutral	+\$0
CN	metallic champagne	+\$0
EH	metallic bronze	+\$0
G1	graphite	+\$0
MS	metallic silver	+\$0
WL	sandstone <input type="checkbox"/> A	+\$0
WN	warm grey neutral	+\$0

Bookcase Surface Support

FT293.

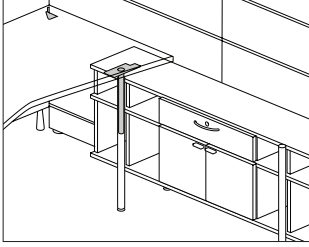

Canvas Office Landscape® Work Surfaces

Product Information

Description

This support post fits into the front leg of a bookcase/bookshelf and attaches to the underside of a concave rectangular surface. It allows the bookcase/bookshelf to support the surface at one end, eliminating the need for a cantilever. Support has a 5" range of adjustment (26 1/2" - 31 1/2" surface height). Finish is black. Attachment hardware included.

Notes

For use with squared-edge surfaces.

Order the following products separately:

- Bookcase (MJ421.)
- Bookshelf (MJ420.)

Dimensions

Specification Information

Step 1.

FT293. \$125

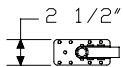
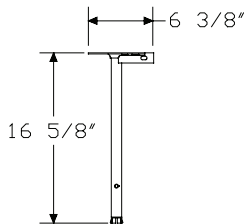

Post Support

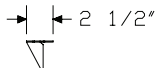
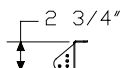
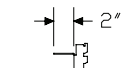

Surface Bracket

Support Panel, Tapered Foot,
Frame Attached

FT291.

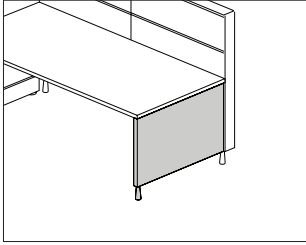

Product Information

Description

This non-handed support panel attaches to a surface and a frame. It can be used as an end panel or a mid-run panel and supports a surface placed at 28 1/2" high. The laminate panel has an open base with a glide that provides an adjustment range of 28 1/2" to 30 1/2". Attachment hardware is included.

Notes

Specify depth of panel to match depth of surface. For mid-run application, specify 12"- or 20"-deep support panel.

For 1/4"-round link and 120° link, 20"-deep support panel is the minimum support requirement.

Dimensions

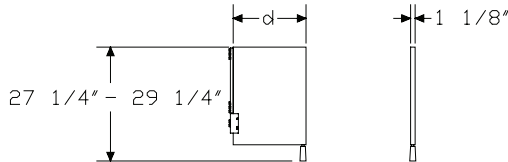

Specification Information

Step 1.

FT291.

Step 2. Depth

12L	12" deep, mid-run
20L	20" deep
24L	24" deep
30L	30" deep

Prices for Steps 1-2.

FT291. 12L	\$195
20L	\$266
24L	\$276
30L	\$286

Step 3. Surface Finish

8Q	folkstone grey	+\$0
91	white	+\$0
98	studio white	+\$0
CL	cool grey neutral	+\$0
G1	graphite	+\$0
WL	sandstone	+\$0
WN	warm grey neutral	+\$0

Support Panel, Frame-Attached FT2E2.

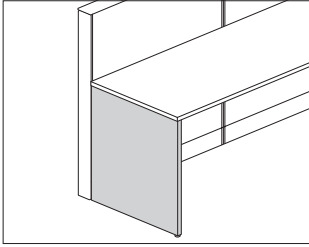

Canvas Office Landscape® Work Surfaces

Product Information

Description
 This non-handed, laminate support panel attaches to a surface and a frame to provide surface support and end or mid-run support to a frame run. It has adjustable glides with a 2" range, allowing a surface height of 28 1/2"-30 1/2". Attachment hardware included.

Notes

For end support, match depth of support panel to depth of surface.
 For mid-run support, specify 12"-deep, shared mid-run option (12L).
 See Canvas planning guide for support capabilities of each frame-attached support option.

Dimensions

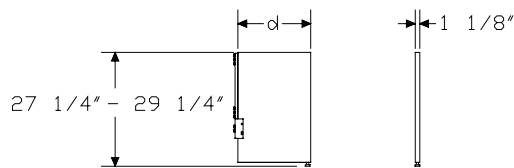

Specification Information

Step 1.

FT2E2. [A]

Step 2. Depth

- 12L** 12" deep, shared mid-run [A]
- 20L** 20" deep [A]
- 24L** 24" deep [A]
- 30L** 30" deep [A]

Prices for Steps 1-2.

FT2E2. 12L	\$177
20L	\$282
24L	\$292
30L	\$297

Step 3. Surface Finish

8Q	folkstone grey [A]	+\$0
91	white [A]	+\$0
98	studio white [A]	+\$0
CL	cool grey neutral [A]	+\$0
G1	graphite [A]	+\$0
WL	sandstone [A]	+\$0
WN	warm grey neutral [A]	+\$0

Open Support, Tapered Foot,
Frame Attached

FT294.

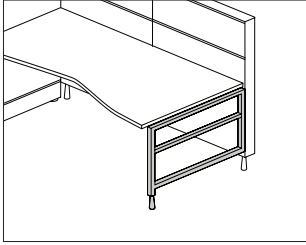

Product Information

Description

This open metal support attaches to a surface and a frame. It can be used as an end panel or a mid-run panel and supports a surface placed at 28 1/2" high. The open support has a glide that provides an adjustment range of 28 1/2" to 30 1/2". Attachment hardware is included.

Notes

Specify depth of support to match depth of surface. For mid-run application, specify 12"- or 20"-deep open support.

For 1/4"-round link and 120° link, 20"-deep open support is the minimum support requirement.

36"-deep open support is for concave rectangular surface (FT211.) only.

To fill top portion of open support, order open support infill (FT297.) separately.

Dimensions

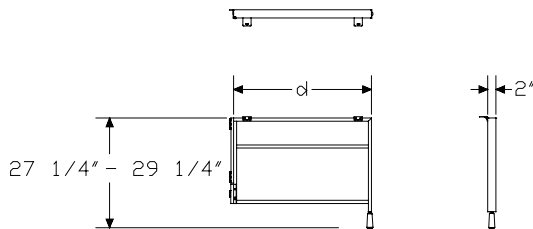

Specification Information

Step 1.

FT294.

Step 2. Depth

12	12" deep, mid-run
20	20" deep
24	24" deep
30	30" deep
36	36" deep

Step 3. Position

L	left-hand support
R	right-hand support

Prices for Steps 1-3.

	L	R
FT294. 12	\$315	315
20	\$424	424
24	\$436	436
30	\$447	447
36	\$458	458

Step 4. Finish

8Q	folkstone grey A	+\$0
98	studio white A	+\$0
WL	sandstone A	+\$0

Bright Sand Texture Paint

91	white	+\$0
CL	cool grey neutral	+\$0
G1	graphite	+\$0
WN	warm grey neutral	+\$0

Metallic Paint

CN	metallic champagne	+\$0
EH	metallic bronze	+\$0
MS	metallic silver	+\$0

Infill, Open Support with Tapered Foot, Frame Attached FT297.

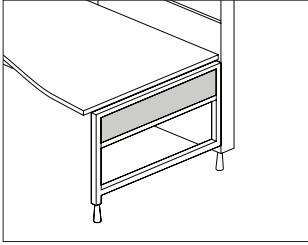

Canvas Office Landscape® Work Surfaces

Product Information

Description

This metal piece fills the top portion of an open support. It can be used for increased closure, modesty, or to add color to a work space.

Notes

For use with frame attached open support with tapered foot (FT294).

Dimensions

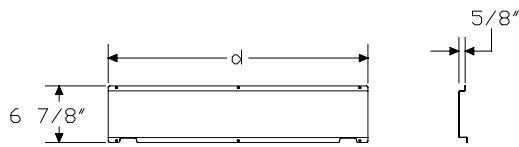

Specification Information

Step 1.

FT297.

Step 2. Depth

12	12" deep
20	20" deep
24	24" deep
30	30" deep
36	36" deep

Prices for Steps 1-2.

FT297. 12	\$116
20	\$121
24	\$124
30	\$131
36	\$135

Step 3. Infill Finish

Sand Texture Paint

8Q	folkstone grey	+\$0
98	studio white	+\$0
WL	sandstone	+\$0

Bright Sand Texture Paint

91	white	+\$0
CL	cool grey neutral	+\$0
G1	graphite	+\$0
WN	warm grey neutral	+\$0

Metallic Paint

CN	metallic champagne	+\$0
EH	metallic bronze	+\$0
MS	metallic silver	+\$0

Open Support, Architectural Foot, Frame Attached FT2A1.

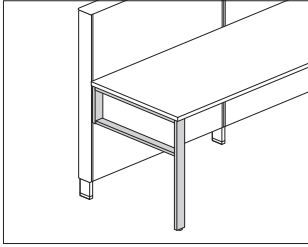

Product Information

Description

This support leg attaches to a surface and a frame to provide surface support and end or mid-run support to a frame run. The fixed-height leg has a 2" leveling range, allowing a surface height of 28 1/2"-30 1/2". The adjustable-height leg is adjustable over a 6" range, allowing a surface height of 25 1/2"-31 1/2". Attachment hardware included.

Notes

For end support, match depth of support panel to depth of surface.

For mid-run support, specify 12"-deep, shared mid-run option (12L).

36"-deep support leg supports a concave rectangular surface (FT211) only.

See Canvas planning guide for support capabilities of each frame-attached support option.

Dimensions

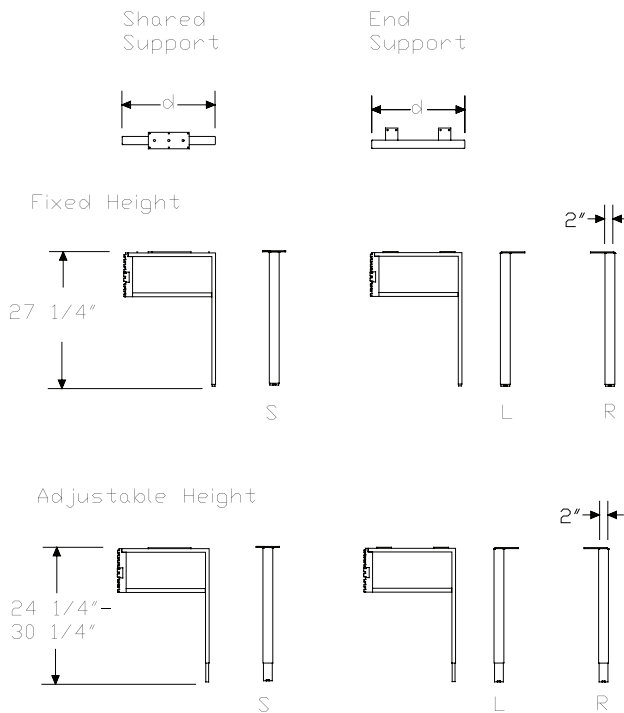

Specification Information

Step 1.

FT2A1.

Step 2. Depth

12	12" deep, shared mid-run
20	20" deep
24	24" deep
30	30" deep
36	36" deep

Step 3. Leg Type

F	fixed height
A	adjustable height

Step 4. Position

L	left-hand support
R	right-hand support

Prices for Steps 1-4.

	L	R
FT2A1. 12 F	\$248	248
A	\$301	301
20 F	\$312	312
A	\$366	366
24 F	\$334	334
A	\$387	387
30 F	\$355	355
A	\$408	408
36 F	\$376	376
A	\$430	430

Step 5. Surface Finish

8Q	folkstone grey A	+\$0
98	studio white A	+\$0
WL	sandstone A	+\$0

Bright Sand Texture Paint

91	white	+\$0
CL	cool grey neutral	+\$0
G1	graphite	+\$0
WN	warm grey neutral	+\$0

Metallic Paint

CN	metallic champagne	+\$0
EH	metallic bronze	+\$0
MS	metallic silver	+\$0

Universal Post Leg, Frame Attached

FT2B1.

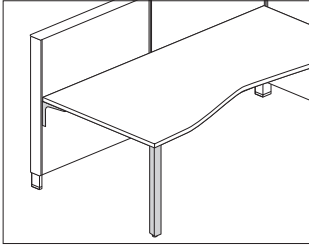

Canvas Office Landscape® Work Surfaces

Product Information

Description

This leg attaches to a surface and has a bracket that attaches to a frame to provide support for the surface and frame run. The fixed-height leg has a 2" leveling range, allowing a surface height of 28½"-30½". The adjustable-height leg is adjustable over a 6" range, allowing a surface height of 25½"-31½". Attachment hardware included.

Dimensions

Fixed Height

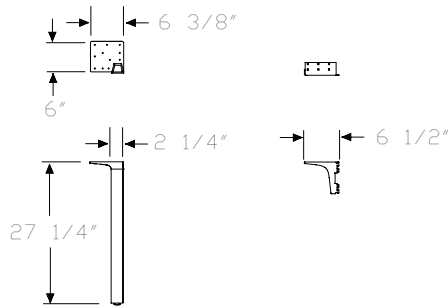

Adjustable Height

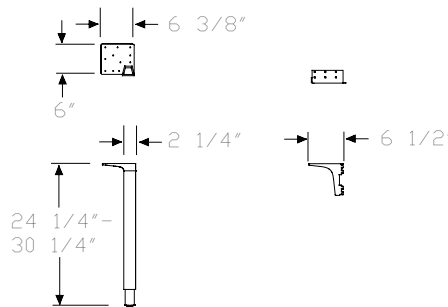

Specification Information

Step 1.

FT2B1.

Step 2. Leg Type

- F** fixed height
- A** adjustable height

Step 3. Position

- L** left-hand support
- R** right-hand support

Prices for Steps 1-3.

	L	R
FT2B1. F	\$449	449
A	\$478	478

Step 4. Leg Body/Frame Bracket Finish

8Q folkstone grey	+\$0
98 studio white	+\$0
WL sandstone	+\$0

Bright Sand Texture Paint

91 white	+\$0
G1 graphite	+\$0

Metallic Paint

MS metallic silver	+\$0
---------------------------	------

Step 5. Leg Face Finish

8Q folkstone grey A	+\$0
98 studio white A	+\$0
WL sandstone A	+\$0

Smooth Paint

91 white	+\$0
G2 graphite satin	+\$0

Metallic Paint

MS metallic silver	+\$0
---------------------------	------

Anodized

AN clear anodized aluminum	+\$10
-----------------------------------	-------

Open Support Leg, Tapered Foot,
Peninsula/D-Shaped Surface
Attached FT2F2.

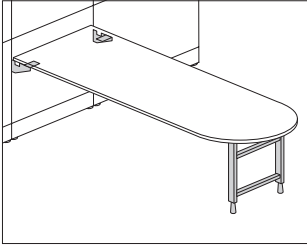

Product Information

Description

This support leg attaches to 1 end of a peninsula or D-shaped surface and is inset from the edge. The adjustable feet have a 2" range, allowing a surface height of 28 1/2"-30 1/2". Attachment hardware included.

Dimensions

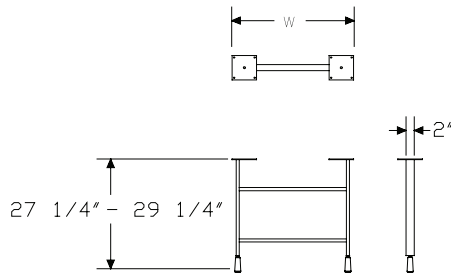

Specification Information

Step 1.

FT2F2.

Step 2. Leg Position

A inset

Step 3. Surface Dimension

- 24** for 24"-deep peninsula
- 30** for 30"-deep peninsula
- 36** for 36"-deep peninsula
- 51** for 51"-wide d-shaped
- 63** for 63"-wide d-shaped

Prices for Steps 1-3.

	24	30	36	51	63
FT2F2. A	\$292	350	364	292	350

Step 4. Surface Finish

- 8Q** folkstone grey **A** +\$0
- 98** studio white **A** +\$0
- WL** sandstone **A** +\$0

Bright Sand Texture Paint

- 91** white +\$0
- CL** cool grey neutral +\$0
- G1** graphite +\$0
- WN** warm grey neutral +\$0

Metallic Paint

- CN** metallic champagne +\$0
- EH** metallic bronze +\$0
- MS** metallic silver +\$0

Open Support Leg, Architectural Foot, Peninsula/D-Shaped Surface Attached FT2A2.

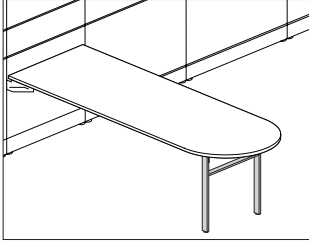

Canvas Office Landscape® Work Surfaces

Product Information

Description
 This support leg attaches to 1 end of a peninsula or D-shaped surface. It can be also be used to create a freestanding peninsula desk. The fixed-height leg has a 2" leveling range, allowing a surface height of 28½"-30½". The adjustable-height leg is adjustable over a 6" range, allowing a surface height of 25½"-31½". Attachment hardware included.

Notes
 For D-shaped surface, specify support leg with inset option (A).
 For peninsula surface attached to a frame or wall strips, specify support leg with inset option (A) or outbound option (B).
 For peninsula supported by a low credenza, specify support leg with outbound option (B).
 To create a freestanding peninsula desk, specify 2 support legs; 1 with inset option (A) and 1 with outbound option (B).

Dimensions

Non-handed Support



Left or Right Hand Support

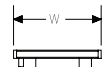

Fixed Height

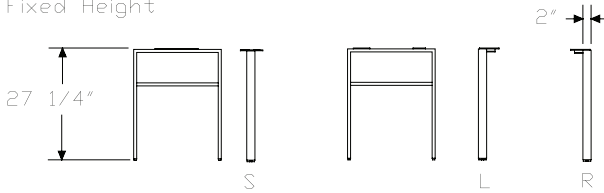

Adjustable Height

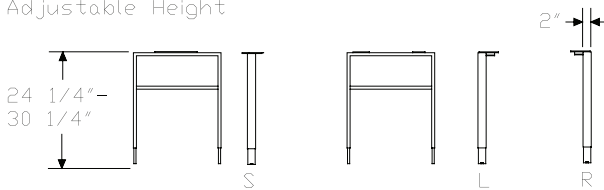

Specification Information

Step 1.

FT2A2.

Step 2. Leg Position

- A** inset
- B** outbound

Step 3. Surface Dimension

For inset (A)

- 24** for 24"-deep peninsula
- 30** for 30"-deep peninsula
- 36** for 36"-deep peninsula
- 51** for 51"-wide d-shaped
- 63** for 63"-wide d-shaped

For outbound (B)

- 24** for 24"-deep peninsula
- 30** for 30"-deep peninsula
- 36** for 36"-deep peninsula

Step 4. Leg Type

- F** fixed height
- A** adjustable height

Step 5. Position

For inset (A)

- S** non-handed support

For outbound (B)

- L** left-hand support
- R** right-hand support

Prices for Steps 1-5.

		FL	FS	FR	AL	AS	AR
FT2A2. A	24	—	\$412	—	—	494	—
	30	—	\$434	—	—	515	—
	36	—	\$456	—	—	537	—
	51	—	\$412	—	—	494	—
	63	—	\$434	—	—	515	—
B	24	\$412	—	412	494	—	494
	30	\$434	—	434	515	—	515
	36	\$456	—	456	537	—	537

Open Support Leg, Architectural
Foot, Peninsula/D-Shaped
Surface Attached *continued*

Step 6. Surface Finish		
8Q	folkstone grey <input type="checkbox"/> A	+\$0
98	studio white <input type="checkbox"/> A	+\$0
WL	sandstone <input type="checkbox"/> A	+\$0
Bright Sand Texture Paint		
91	white	+\$0
CL	cool grey neutral	+\$0
G1	graphite	+\$0
WN	warm grey neutral	+\$0
Metallic Paint		
CN	metallic champagne	+\$0
EH	metallic bronze	+\$0
MS	metallic silver	+\$0

Square Open Support Leg,
Peninsula Attached

FV2D1.

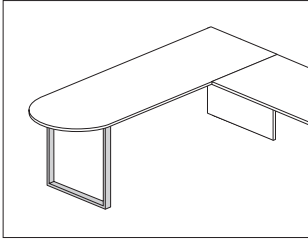

Canvas Office Landscape® Work Surfaces

Product Information

Description

This leg supports a 1 end of a peninsula surface and is inset from the edge. It has leveling glides with 1½" of adjustment. Attachment hardware included.

Dimensions

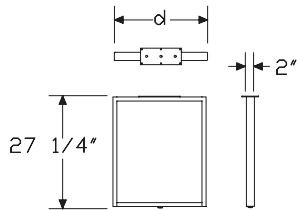

Specification Information

Step 1.

FV2D1.

Step 2. Leg Position

A inset

Step 3. Surface Depth

24 for 24"-deep surface

30 for 30"-deep surface

36 for 36"-deep surface

Step 4. Leg Type

F fixed height

Prices for Steps 1-4.

	F
FV2D1. A 24	\$218
30	\$337
36	\$337

Step 5. Surface Finish

Bright Sand Texture Paint

91	white	+\$0
CL	cool grey neutral	+\$0
G1	graphite	+\$0
WN	warm grey neutral	+\$0
8Q	folkstone grey	+\$0
98	studio white	+\$0
WL	sandstone	+\$0

Metallic Paint

CN	metallic champagne	+\$0
EH	metallic bronze	+\$0
MS	metallic silver	+\$0

Universal Post Leg

FT2B2.

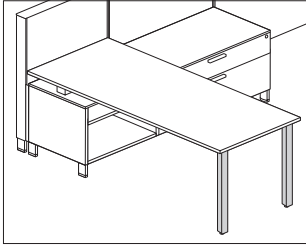

Product Information

Description

This leg is available as a single leg to support 1 corner of a surface, or as a pair to support 1 end of a surface. The fixed-height leg has a 2" leveling range, allowing a surface height of 28¹/₂"-30¹/₂". The adjustable-height leg is adjustable over a 6" range, allowing a surface height of 25¹/₂"-31¹/₂". Attachment hardware included.

Dimensions

Fixed Height

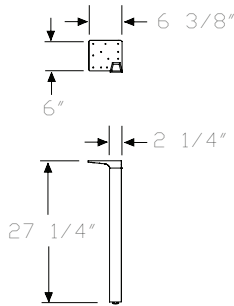

Adjustable Height

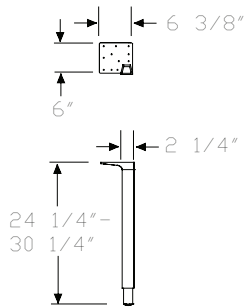

Specification Information

Step 1.

FT2B2.

Step 2. Leg Type

- F** fixed height
- A** adjustable height

Step 3. Position

- L** left-hand, single leg
- R** right-hand, single leg
- P** left-hand & right-hand, pair

Prices for Steps 1-3.

	L	R	P
FT2B2. F	\$389	389	773
A	\$416	416	830

Step 4. Leg Body Finish

8Q	folkstone grey		+\$0
98	studio white		+\$0
WL	sandstone		+\$0

Bright Sand Texture Paint

91	white		+\$0
G1	graphite		+\$0

Metallic Paint

MS	metallic silver		+\$0
-----------	-----------------	--	------

Step 5. Leg Face Finish

Smooth Paint

		L	R	P
8Q	folkstone grey	+\$0	0	0
91	white	+\$0	0	0
98	studio white	+\$0	0	0
G2	graphite satin	+\$0	0	0
WL	sandstone	+\$0	0	0

Metallic Paint

		L	R	P
MS	metallic silver	+\$0	0	0

Anodized

		L	R	P
AN	clear anodized aluminum	+\$10	10	20

Support Leg, Post

FV689.

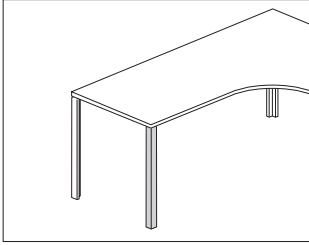

Canvas Office Landscape® Work Surfaces

Product Information

Description
 This single painted leg supports a desk or return and includes a glide with 1½" leveling range. Specify 2 legs to support one end of a surface. Attachment hardware included.

Dimensions

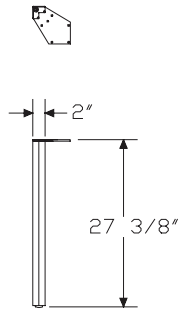

Specification Information

Step 1.
FV689.P \$158

Step 2. Surface Finish

Bright Sand Texture Paint		
91	white	+\$0
CL	cool grey neutral	+\$0
G1	graphite	+\$0
WN	warm grey neutral	+\$0
Metallic Paint		
CN	metallic champagne	+\$0
EH	metallic bronze	+\$0
MS	metallic silver	+\$0

Surface Support, Low Credenza, Fixed Height FT298.

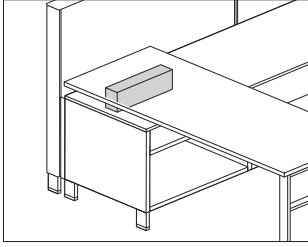

Product Information

Description

This support allows a low credenza to support 1 end of a surface and places the surface at 28 1/2" high. Attachment hardware included.

Notes

Support heights are:

- 5 1/8" high for storage type (M)
- 6 7/8" high for storage type (S)
- 6" high for storage type (R)
- 4 1/4" high for storage type (W)

Dimensions

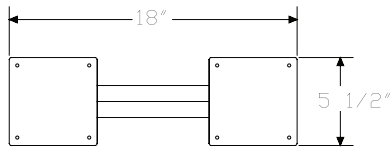

Specification Information

Step 1.

FT298.

Step 2. Storage Type

- M** for use with thin top low credenza with 4" high foot
- S** for use with thin top low credenza with 2 1/4" high base
- R** for use with 1 1/4" top low credenza with 2 1/4" high base
- W** for use with 1 1/4" top low credenza with 4" high foot

Prices for Steps 1-2.

FT298. M	\$189
S	\$189
R	\$189
W	\$189

Step 3. Surface Finish

Bright Sand Texture Paint

91	white	+\$0
CL	cool grey neutral	+\$0
G1	graphite	+\$0
WN	warm grey neutral	+\$0
8Q	folkstone grey A	+\$0
98	studio white A	+\$0
WL	sandstone A	+\$0

Metallic Paint

CN	metallic champagne	+\$0
EH	metallic bronze	+\$0
MS	metallic silver	+\$0

Surface Support, Low Credenza, FT299. Adjustable Height

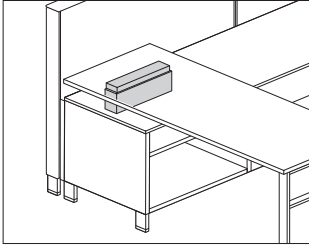

Canvas Office Landscape® Work Surfaces

Product Information

Description
 This height-adjustable support allows a low credenza to support 1 end of a surface, and provides 3" of height adjustment for the surface. Attachment hardware included.

Notes

In lowest position, the height of supports is as follows:
 • 3⁵/₈" high for storage type (M)
 • 5³/₈" high for storage type (S)
 When used with low credenza with 3/8" thin top, surface adjustment height range is 27" - 30".
 When used with low credenza with 1/4" thick top, surface adjustment height range is 27⁵/₈" - 30⁵/₈".

Dimensions

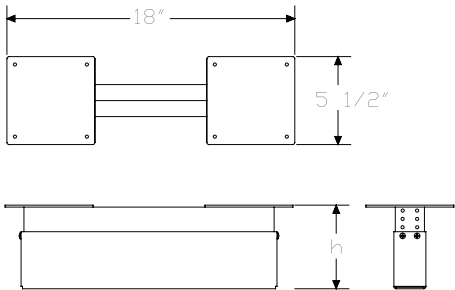

Specification Information

Step 1.

FT299.

Step 2. Storage Type

- M** for use with low credenza with 4" high foot
- S** for use with low credenza with 2¹/₄" high base

Prices for Steps 1-2.

FT299. M	\$318
S	\$318

Step 3. Surface Finish

Bright Sand Texture Paint

91	white	+\$0
CL	cool grey neutral	+\$0
G1	graphite	+\$0
WN	warm grey neutral	+\$0
8Q	folkstone grey	+\$0
98	studio white	+\$0
WL	sandstone	+\$0

Metallic Paint

CN	metallic champagne	+\$0
EH	metallic bronze	+\$0
MS	metallic silver	+\$0

Stiffener

FV696.

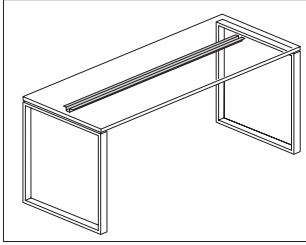

Product Information

Description

This stiffener is used to add additional stiffness to a Canvas freestanding surface, Canvas or Ethospace® surface-attached surface, peninsula or any frame-attached surface when a center cantilever cannot be used. Attachment hardware included.

Notes

Canvas and Ethospace laminate or veneer surfaces 54" wide or wider and painted formcoat surfaces 48" wide or wider that cannot use a center cantilever require stiffener(s).

See Canvas Office Landscape® Planning Guide or Ethospace Work Surface Planning Guide for specific stiffener guidelines.

Stiffener hangs below surface and is 1 1/4" high.

Dimensions

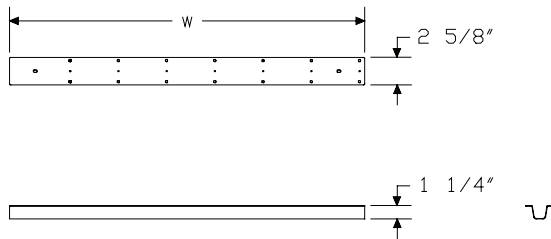

Specification Information

Step 1.

FV696.

Step 2. Width

34	33 7/8" wide
39	38 5/8" wide
43	43 1/4" wide
48	48" wide
57	57 3/8" wide
62	62 1/8" wide
67	66 3/4" wide
71	71 1/2" wide
81	80 7/8" wide

Prices for Steps 1-2.

FV696. 34	\$69
39	\$71
43	\$71
48	\$71
57	\$71
62	\$71
67	\$71
71	\$71
81	\$71

Square Open Support Leg

FV2D2.

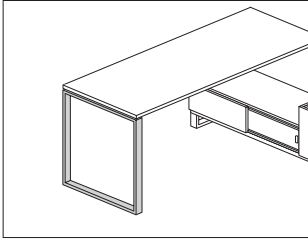

Canvas Office Landscape® Work Surfaces

Product Information

Description
This individual leg supports 1 end of a surface or joins 2 surfaces end-to-end, providing shared support at the surface joint. It has leveling glides with 1½" of adjustment. Attachment hardware included.

Notes

When leg is supporting the end of a squared- or eased-edge surface, depth of support leg must match depth of surface. Support leg does not work with thin-edge surfaces in this position.
When leg is supporting the joint between 2 surfaces, specify leg as follows:

- Surface Depth—Leg Depth
 24" deep surface—12" deep leg
 30" deep surface—24" deep leg
 36" deep surface—24" deep leg

Dimensions

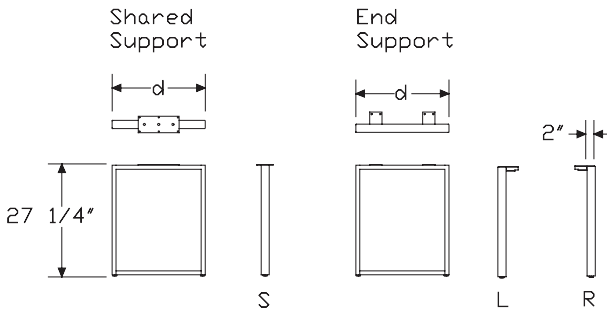

Specification Information

Step 1.

FV2D2.

Step 2. Surface Edge Type

S for squared edge surface

Step 3. Depth

- 2A** 12" deep, shared
- 2B** 24" deep, shared
- 24** 24" deep
- 30** 30" deep
- 36** 36" deep

Step 4. Leg Type

F fixed height

Step 5. Position

For 12" deep, shared (2A) or 24" deep, shared (2B)

S shared

For 24" deep (24), 30" deep (30), or 36" deep (36)

- L** left
- R** right

Prices for Steps 1-5.

		FL	FS	FR
FV2D2. S	2A	—	\$218	—
	2B	—	\$337	—
	24	\$337	—	337
	30	\$346	—	346
	36	\$356	—	356

Step 6. Surface Finish

- 8Q** folkstone grey +\$0
- 98** studio white +\$0
- WL** sandstone +\$0

Bright Sand Texture Paint

- 91** white +\$0
- CL** cool grey neutral +\$0
- G1** graphite +\$0
- WN** warm grey neutral +\$0

Square Open Support Leg *continued*

Metallic Paint

CN	metallic champagne	+\$0
EH	metallic bronze	+\$0
MS	metallic silver	+\$0

Open Support Leg, Architectural Foot

FV2A2.

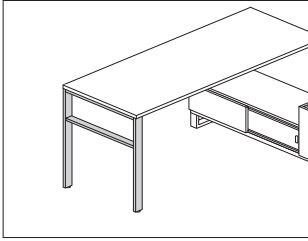

Canvas Office Landscape® Work Surfaces

Product Information

Description
 This individual leg supports 1 end of a surface or joins 2 surfaces end-to-end, providing shared support at the surface joint. The fixed height leg has a 2" leveling range allowing a surface height of 28½"-30½". The adjustable height leg has a 6" adjustment range in 1" increments allowing a surface height of 25½"-31½". Attachment hardware included.

Notes
 When leg is supporting the end of a surface, depth of support leg must match depth of surface.
 When leg is supporting the joint between 2 surfaces, specify leg as follows:
 Surface Depth—Leg Depth
 24" deep surface—12" deep leg
 30" deep surface—24" deep leg
 36" deep surface—24" deep leg

Dimensions

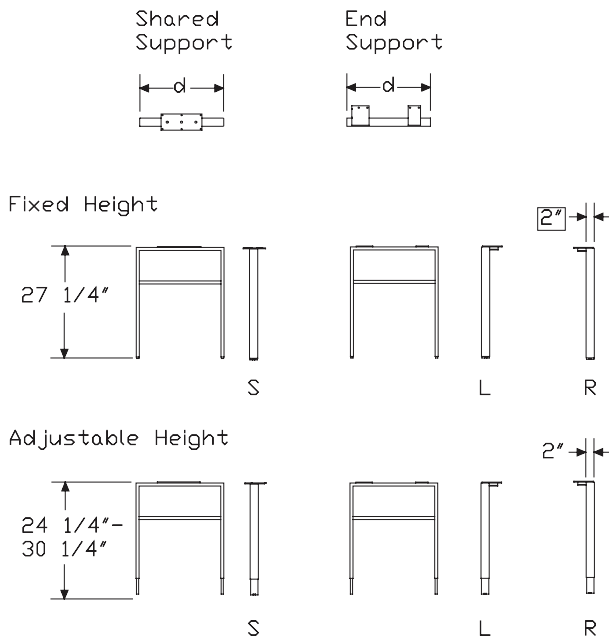

Specification Information

- Step 1.**
FV2A2.
- Step 2. Depth**
- 2A** 12" deep, shared
 - 2B** 24" deep, shared
 - 24** 24" deep
 - 30** 30" deep
 - 36** 36" deep
- Step 3. Leg Type**
- F** fixed height
 - A** adjustable height
- Step 4. Position**
- For 12" deep, shared (2A) or 24" deep, shared (2B)*
- S** shared
- For 24" deep (24), 30" deep (30), or 36" deep (36)*
- L** left
 - R** right

Prices for Steps 1-4.

	L	S	R
FV2A2. 2A F	—	\$262	—
A	—	\$346	—
2B F	—	\$431	—
A	—	\$515	—
24 F	\$431	—	431
A	\$515	—	515
30 F	\$453	—	453
A	\$538	—	538
36 F	\$476	—	476
A	\$560	—	560

Step 5. Surface Finish

8Q	folkstone grey	+\$0
98	studio white	+\$0
WL	sandstone	+\$0

Bright Sand Texture Paint

91	white	+\$0
CL	cool grey neutral	+\$0
G1	graphite	+\$0
WN	warm grey neutral	+\$0

Open Support Leg, Architectural Foot *continued*

Metallic Paint		
CN	metallic champagne	+\$0
EH	metallic bronze	+\$0
MS	metallic silver	+\$0

Closed Support Leg

FV2E2.

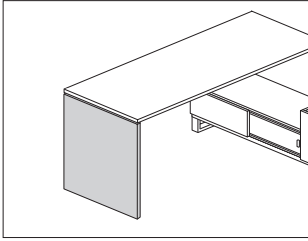

Canvas Office Landscape® Work Surfaces

Product Information

Description

This individual solid panel leg supports 1 end of a surface or joins 2 surfaces end-to-end, providing shared support at the surface joint. It is available as laminate or veneer and has leveling glides with 1½" of adjustment. Attachment hardware included.

Notes

For additional product options, see Vary Easy Program in Appendices.
 Grain direction is vertical on wood-grain laminate and veneer.
 When leg is supporting the end of a squared- or eased-edge surface, depth of support leg must match depth of surface. Support leg does not work with thin-edge surfaces in this position.
 When leg is supporting the joint between 2 surfaces, specify leg as follows:

Surface Depth—Leg Depth

- 24" deep surface—12" deep leg
- 30" deep surface—24" deep leg
- 36" deep surface—24" deep leg

Dimensions

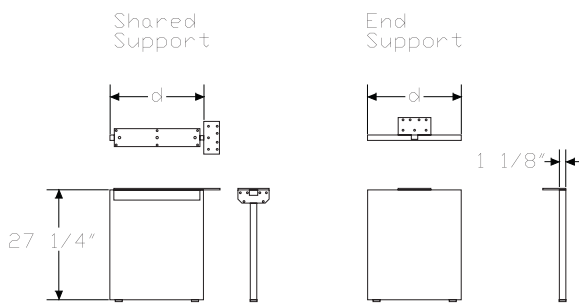

Specification Information

Step 1.

FV2E2.

Step 2. Surface Edge Type

S for squared edge surface

Step 3. Depth

- 2A** 12" deep, shared
- 2B** 24" deep, shared
- 24** 24" deep
- 30** 30" deep
- 36** 36" deep

Step 4. Leg Type

F fixed height

Step 5. Surface Material

- L** laminate
- W** veneer A

Prices for Steps 1-5.

		FL	FW
FV2E2.	S 2A	\$173	450
	2B	\$285	591
	24	\$285	591
	30	\$290	608
	36	\$295	797

Step 6. Surface Finish

Solid-Color Laminate

For laminate (L)

8Q	folkstone grey	+\$0
91	white	+\$0
98	studio white	+\$0
CL	cool grey neutral	+\$0
LU	soft white	+\$0
MT	medium tone <input type="checkbox"/> A	+\$0
WL	sandstone	+\$0
WN	warm grey neutral	+\$0

Linen Laminate

For laminate (L)

LBM	crisp linen	+\$0
LBN	classic linen	+\$0
LBP	casual linen	+\$0

Closed Support Leg *continued*

Mesh Laminate

For laminate (L)

LBK	pewter mesh	+\$0
LBL	steel mesh	+\$0

Twill Laminate

For laminate (L)

LBF	neutral twill	+\$0
LBG	sarum twill	+\$0
LBH	earthen twill	+\$0
LBJ	graphite twill	+\$0
LBQ	white twill	+\$0

Wood-Grain Laminate

For laminate (L)

HM	natural maple	+\$0
HP	light anigre	+\$0
LBA	clear on ash	+\$0
LBR	phantom ecru	+\$0
LBS	phantom cocoa	+\$0
LBU	medium matte walnut	+\$0
LBV	warm grey teak	+\$0
LBB	oak on ash	+\$0
LBC	walnut on ash	+\$0
LBD	dark brown walnut	+\$0
LBE	medium red walnut	+\$0
76	light brown walnut	+\$0
HX	aged cherry	+\$0
HY	walnut on cherry	+\$0

Wood Veneer

For veneer (W)

2U	light brown walnut A	+\$85
40	dark brown walnut A	+\$85
ED	aged cherry A	+\$85
EK	medium red walnut A	+\$85
EW	medium matte walnut A	+\$85
ET	clear on ash A	+\$85
EU	oak on ash A	+\$85
EV	walnut on ash A	+\$85
UL	natural maple A	+\$85
UX	walnut on cherry A	+\$85

Canvas Cabinet/Wall Attachment Bracket FV692.

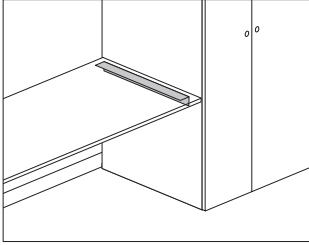

Canvas Office Landscape® Work Surfaces

Product Information

Description

This bracket attaches 1 end of a surface to a Canvas wood vertical storage cabinet or architectural wall, eliminating the need for a support leg. Finish is black. Attachment hardware included.

Notes

Supports a 20" or 24" deep surface.

 20" deep surface can be attached to a 20" or 24" deep wood vertical storage cabinet or architectural wall.

 24" deep surface can be attached to a 24" deep wood vertical storage cabinet or architectural wall.

Dimensions

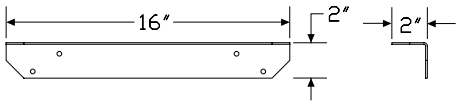

Specification Information

Step 1.

FV692. \$66

Canvas Vertical Tower Attachment Bracket FM930.

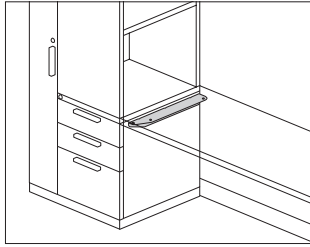

Product Information

Description

This bracket attaches to the side of a Canvas metal vertical storage tower to support 1 end of a 24" deep surface, eliminating the need for a support leg or cantilever. Finish is black. Attachment hardware included.

Notes

Bracket must attach to the pedestal side of storage tower.
Bracket does not provide support for a panel or frame.

Dimensions

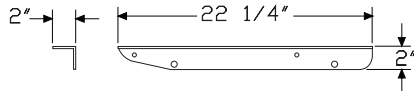

Specification Information

Step 1.

FM930.

\$43

Tu® Storage Tower Attachment Bracket

LG692

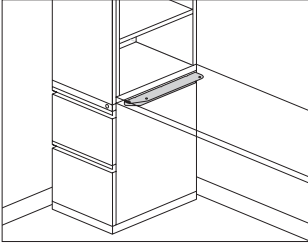

Canvas Office Landscape® Work Surfaces

Product Information

Description
This bracket attaches to the side of a Tu Metal storage tower to support 1 end of a 24" deep surface, eliminating the need for a support leg or cantilever. Finish is black. Attachment hardware included.

Notes

Bracket must attach to the pedestal side of a metal storage tower.
Bracket does not provide support for a panel or frame.

Dimensions

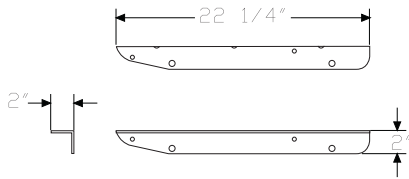

Specification Information

Step 1.
LG692 \$43

Meridian® Vertical Tower Attachment Bracket

MTAB.

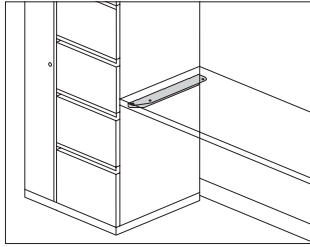

Product Information

Description

This bracket attaches to the side of a Meridian vertical storage tower to support 1 end of a 24" deep surface, eliminating the need for a support leg or cantilever. Finish is black. Attachment hardware included.

Notes

Bracket must attach to the pedestal side of storage tower.
Bracket does not provide support for a panel or frame.

Dimensions

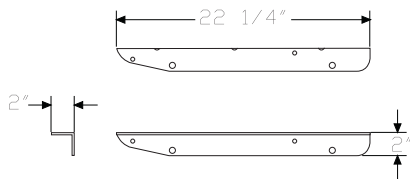

Specification Information

Step 1.

MTAB.

\$41

Fixed Surface Support, Low
Credenza, Power Chase

FV298.

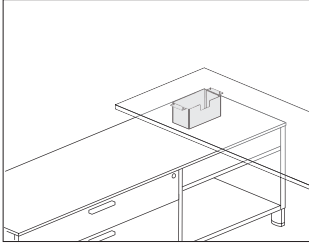

Product Information

Description

This power chase support allows a low credenza to support 1 end of a surface and places the surface at 28 1/2" high. The support is open to allow cords to route from surface through top of credenza and through to wall. Attachment hardware included.

Notes

Support heights:

Storage Type—Height

M—5 1/8"

S—6 7/8"

R—6"

W—4 1/4"

For use with wood low credenza, open with drawers, power access (FFV73.), ordered separately.

Support is sized for the 6-module Logic G1000 grommet mounted electrical distributor (Y1425.D or .G).

Dimensions

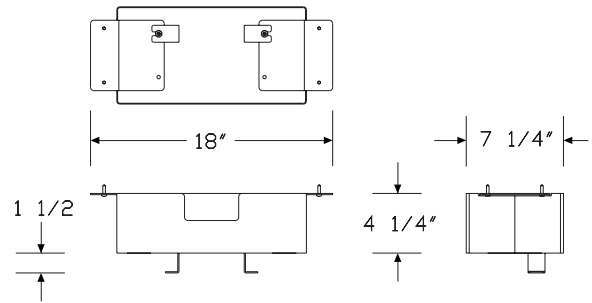

W - 1 1/4" top, 4" high foot

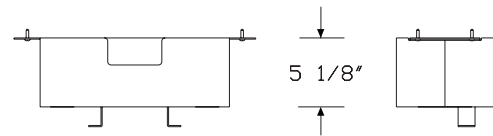

M - Thin top, 4" high foot

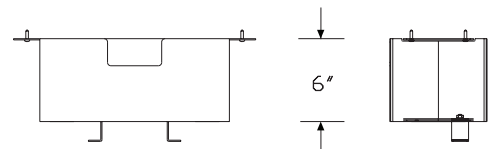

R - 1 1/4" top, 2 1/4" high foot

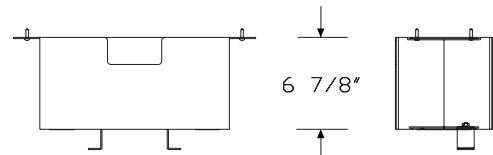

S - Thin top, 2 1/4" high foot

Fixed Surface Support, Low Credenza, Power Chase *continued*

Specification Information

Step 1.

FV298.

Step 2. Storage Type

M for use with thin top low credenza with 4" high foot

S for use with thin top low credenza with 2 1/4" high base

R for use with 1 1/4" top low credenza with 2 1/4" high base

W for use with 1 1/4" top low credenza with 4" high foot

Prices for Steps 1-2.

FV298. M	\$250
S	\$250
R	\$250
W	\$250

Step 3. Surface Finish

8Q folkstone grey <input type="checkbox"/>	+\$0
91 white <input type="checkbox"/>	+\$0
98 studio white <input type="checkbox"/>	+\$0
CL cool grey neutral <input type="checkbox"/>	+\$0
CN metallic champagne <input type="checkbox"/>	+\$0
EH metallic bronze <input type="checkbox"/>	+\$0
G1 graphite <input type="checkbox"/>	+\$0
MS metallic silver <input type="checkbox"/>	+\$0
WL sandstone <input type="checkbox"/>	+\$0
WN warm grey neutral <input type="checkbox"/>	+\$0

Support Panel, Frame-Attached FT2G2.

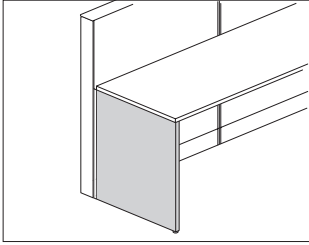

Canvas Office Landscape® Work Surfaces

Product Information

Description

This handed support panel attaches to a surface and a frame to provide surface support and end or mid-run support to a frame run. It has adjustable glides with a 2" range, allowing a surface height of 28 1/2"-30 1/2". Attachment hardware included.

Notes

For end support, match depth of support panel to depth of surface, and match edge types.
 For mid-run support, specify 12"-deep, shared mid-run option (2A) on applications with 20"-deep or 24"-deep surfaces that are 12' or less; 20"-deep or 24"-deep supports also provide mid-run support when surfaces are deeper or when longer applications are required.
 See Canvas planning guide for support capabilities of each frame-attached support option.

Dimensions

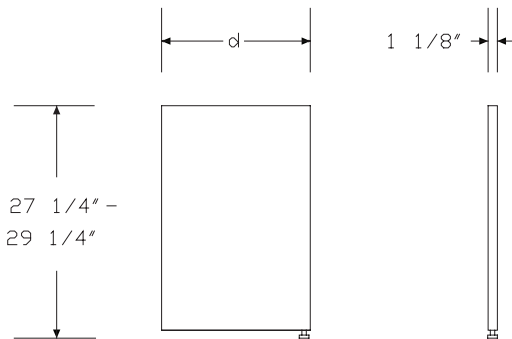

Specification Information

Step 1.

FT2G2. A

Step 2. Surface Edge Type

- S** squared-edge A
- T** thin-edge A
- E** eased-edge A

Step 3. Depth

- 2A** 12" deep, shared mid-run A
- 20** 20" deep A
- 24** 24" deep A
- 30** 30" deep A

Step 4. Position

For 20" deep (20), 24" deep (24), or 30" deep (30)

- L** left-hand support A
- R** right-hand support A

For 12" deep, shared mid-run (2A)

- S** shared, mid-run A

Step 5. Surface Material

- L** laminate A
- W** veneer A

Prices for Steps 1-5.

		LL	LW	SL	SW	RL	RW
FT2G2. S	2A	—	—	\$177	460	—	—
	20	\$282	578	—	—	282	578
	24	\$292	606	—	—	292	606
	30	\$297	623	—	—	297	623
T	2A	—	—	\$177	460	—	—
	20	\$282	578	—	—	282	578
	24	\$292	606	—	—	292	606
	30	\$297	623	—	—	297	623
E	2A	—	—	\$177	460	—	—
	20	\$282	578	—	—	282	578
	24	\$292	606	—	—	292	606
	30	\$297	623	—	—	297	623

Support Panel, Frame-Attached

continued

Step 6. Surface Finish

For laminate (L)

8Q	folkstone grey <input type="checkbox"/>	+\$0
91	white <input type="checkbox"/>	+\$0
98	studio white <input type="checkbox"/>	+\$0
CL	cool grey neutral <input type="checkbox"/>	+\$0
G1	graphite <input type="checkbox"/>	+\$0
LU	soft white <input type="checkbox"/>	+\$0
MT	medium tone <input type="checkbox"/>	+\$0
WL	sandstone <input type="checkbox"/>	+\$0
WN	warm grey neutral <input type="checkbox"/>	+\$0

For laminate (L)

LBM	crisp linen <input type="checkbox"/>	+\$0
LBN	classic linen <input type="checkbox"/>	+\$0
LBP	casual linen <input type="checkbox"/>	+\$0

For laminate (L)

LBK	pewter mesh <input type="checkbox"/>	+\$0
LBL	steel mesh <input type="checkbox"/>	+\$0

For laminate (L)

LBF	neutral twill <input type="checkbox"/>	+\$0
LBG	sarum twill <input type="checkbox"/>	+\$0
LBH	earthen twill <input type="checkbox"/>	+\$0
LBJ	graphite twill <input type="checkbox"/>	+\$0
LBQ	white twill <input type="checkbox"/>	+\$0

For laminate (L)

76	light brown walnut <input type="checkbox"/>	+\$0
HM	natural maple <input type="checkbox"/>	+\$0
HP	light anigre <input type="checkbox"/>	+\$0
HX	aged cherry <input type="checkbox"/>	+\$0
HY	walnut on cherry <input type="checkbox"/>	+\$0
LBA	clear on ash <input type="checkbox"/>	+\$0
LBR	phantom ecru <input type="checkbox"/>	+\$0
LBS	phantom cocoa <input type="checkbox"/>	+\$0
LBU	medium matte walnut <input type="checkbox"/>	+\$0
LBV	warm grey teak <input type="checkbox"/>	+\$0
LBB	oak on ash <input type="checkbox"/>	+\$0
LBC	walnut on ash <input type="checkbox"/>	+\$0
LBD	dark brown walnut <input type="checkbox"/>	+\$0
LBE	medium red walnut <input type="checkbox"/>	+\$0

For veneer (W)

2U	light brown walnut <input type="checkbox"/>	+\$0
40	dark brown walnut <input type="checkbox"/>	+\$0
ED	aged cherry <input type="checkbox"/>	+\$0
EK	medium red walnut <input type="checkbox"/>	+\$0
EW	medium matte walnut <input type="checkbox"/>	+\$0
ET	clear on ash <input type="checkbox"/>	+\$0
EU	oak on ash <input type="checkbox"/>	+\$0
EV	walnut on ash <input type="checkbox"/>	+\$0
UL	natural maple <input type="checkbox"/>	+\$0
UX	walnut on cherry <input type="checkbox"/>	+\$0

Step 7. Attachment Bracket Finish

8Q	folkstone grey <input type="checkbox"/>	+\$0
91	white <input type="checkbox"/>	+\$0
98	studio white <input type="checkbox"/>	+\$0
CL	cool grey neutral <input type="checkbox"/>	+\$0
G1	graphite <input type="checkbox"/>	+\$0
LU	soft white <input type="checkbox"/>	+\$0
MT	medium tone <input type="checkbox"/>	+\$0
WL	sandstone <input type="checkbox"/>	+\$0
WN	warm grey neutral <input type="checkbox"/>	+\$0

Cable Manager

FV695.

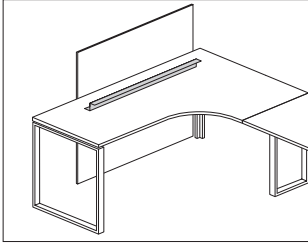

Canvas Office Landscape® Work Surfaces

Product Information

Description

This cable manager attaches beneath a surface to provide routing of cables and cords at the back edge of a desk or return. Attachment hardware included.

Notes

When using cable manager with privacy panel or screen, specify cable manager width 12" less than privacy panel or screen width.

Dimensions

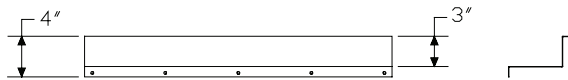
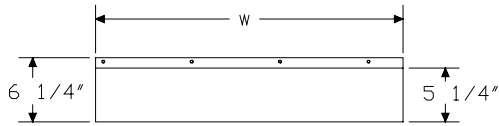

Specification Information

Step 1.

FV695.

Step 2. Width

18	18" wide
24	24" wide
30	30" wide
36	36" wide
42	42" wide
48	48" wide

Prices for Steps 1-2.

FV695. 18	\$65
24	\$71
30	\$77
36	\$82
42	\$89
48	\$97

Step 3. Surface Finish

Bright Sand Texture Paint

91	white	+\$0
CL	cool grey neutral	+\$0
G1	graphite	+\$0
WN	warm grey neutral	+\$0
8Q	folkstone grey	+\$0
98	studio white	+\$0
WL	sandstone	+\$0

Metallic Paint

CN	metallic champagne	+\$0
EH	metallic bronze	+\$0
MS	metallic silver	+\$0

Cable Management Trough

FT199.

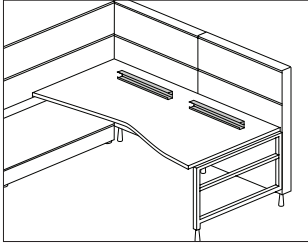

Product Information

Description

This trough attaches along the underside of a Canvas surface to hold and manage power/data cables. It includes two 14"-wide troughs. Finish is black. Attachment hardware is included.

Dimensions

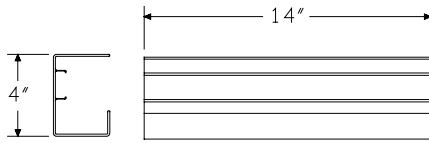

Specification Information

Step 1.

FT199.

\$68

Cable Management Channel

FT19C.

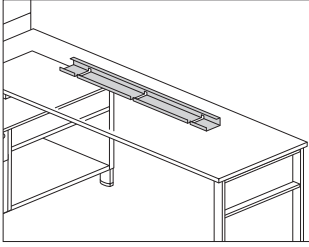

Canvas Office Landscape® Work Surfaces

Product Information

Description

This channel attaches to the underside of a surface to hold and manage cords and cables. Attachment hardware included.

Dimensions

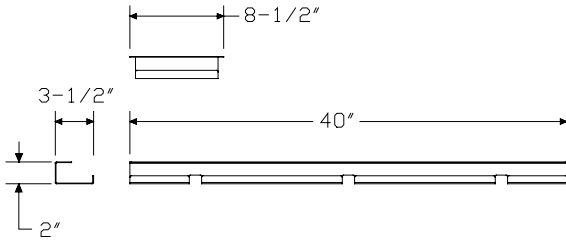

Specification Information

Step 1.

FT19C. A

Step 2. Width

08 8" wide A

40 40" wide A

Prices for Steps 1-2.

FT19C. 08	\$41
40	\$74

Cord Cleat

G1331.

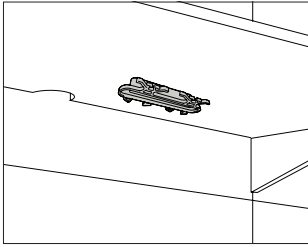

Product Information

Description

This cleat attaches to the underside of a work surface or table to manage cords and cables. Finish is cool grey neutral. Package contains 2.

Dimensions

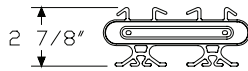
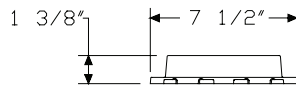

Specification Information

Step 1.

G1331.

\$21

Vertical Cable Manager

FV698.

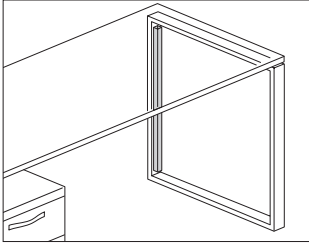

Canvas Office Landscape® Work Surfaces

Product Information

Description

This plastic cable manager adheres with double-sided tape to a desk leg to route cords and cables from the floor to the surface. Package of 6.

Dimensions

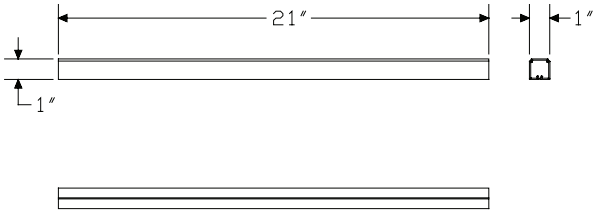

Specification Information

Step 1.

FV698.21 \$55

Step 2. Surface Finish

8Q	folkstone grey	+\$0
91	white	+\$0
98	studio white	+\$0
CL	cool grey neutral	+\$0
G2	graphite satin	+\$0
WL	sandstone	+\$0
WN	warm grey neutral	+\$0

Grommet Kit, Surface

FV982.

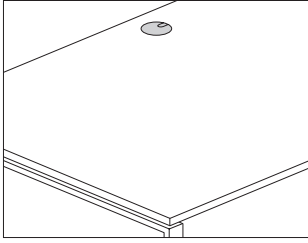

Product Information

Description

This grommet kit allows cords and cables to be routed through a surface. Includes a template for proper placement. Package of 6.

Notes

Grommet kit requires field-drilling of surface.

Dimensions

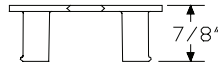
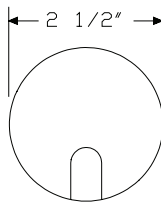

Specification Information

Step 1.

FV982. \$35

Step 2. Grommet Finish

8Q	folkstone grey	+\$0
91	white	+\$0
98	studio white	+\$0
CL	cool grey neutral	+\$0
G2	graphite satin	+\$0
LU	soft white	+\$0
MT	medium tone	+\$0
WL	sandstone	+\$0
WN	warm grey neutral	+\$0

Storage Cabinet, Frame Top, Mounted, Open

FT415.

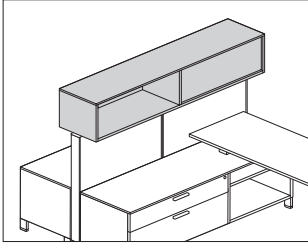

Canvas Office Landscape® Storage

Product Information

Description

This cabinet mounts centered to the top of a frame, or frames, to provide overhead storage on 1 or both sides. Frame top cap(s) and attachment hardware included.

Notes

For additional product options, see Vary Easy Program in Appendices. Match width of cabinet to the width of a frame, or the combined width of 2 frames.

Double-sided option (D) allows 1/2 of the cabinet to be accessed from each side of the frame. Single-sided option (S) allows the entire cabinet to be accessed from 1 side of the frame.

Attaches to frames up to 57" high.

Specify optional marker board (FT492.) or tackboard (FT491.) separately.

Dimensions

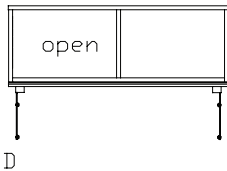
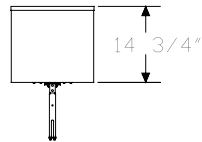
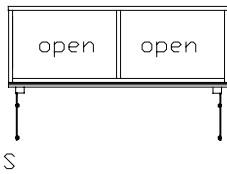
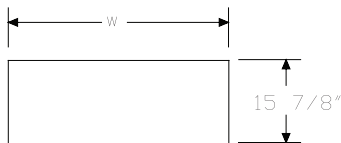

Specification Information

Step 1.

FT415.

Step 2. Width

36	36" wide
42	42" wide
48	48" wide
60	60" wide
72	72" wide
84	84" wide
96	96" wide

Step 3. Frame Top Cap Options

P	painted standard top cap
W	veneer standard top cap A
A	painted architectural top cap

Step 4. Storage Type

D	double-sided
S	single-sided

Step 5. Position

For double-sided (D)

L	opening left
R	opening right

For single-sided (S)

S	opening left and right
----------	------------------------

Step 6. Surface Material

L	laminate
W	veneer A

Prices for Steps 1-6.

		DLL	DLW	DRL	DRW	SSL	SSW
FT415. 36	P	\$1152	2572	1152	2572	1060	2366
	W	\$1284	2727	1284	2727	1192	2520
	A	\$1228	2661	1228	2661	1135	2456
42	P	\$1200	2752	1200	2752	1104	2532
	W	\$1353	2929	1353	2929	1256	2709
	A	\$1284	2851	1284	2851	1189	2631
48	P	\$1252	2943	1252	2943	1152	2707
	W	\$1422	3143	1422	3143	1322	2908
	A	\$1346	3053	1346	3053	1246	2816

Storage Cabinet, Frame Top, Mounted, Open *continued*

60 P	\$1384	3335	1384	3335	1274	3070
W	\$1592	3581	1592	3581	1481	3314
A	\$1495	3466	1495	3466	1384	3200
72 P	\$1515	3744	1515	3744	1396	3445
W	\$1782	4056	1782	4056	1661	3757
A	\$1646	3894	1646	3894	1524	3596
84 P	\$1765	4518	1765	4518	1613	4145
W	\$2067	4875	2067	4875	1914	4502
A	\$1891	4667	1891	4667	1741	4295
96 P	\$1981	5091	1981	5091	1810	4670
W	\$2321	5491	2321	5491	2152	5071
A	\$2136	5273	2136	5273	1967	4853

Step 7. Top/Edge Finish

Solid-Color Laminate Top/Thermoplastic Edge

For laminate (L)

8Q	folkstone grey	+\$0
91	white	+\$0
98	studio white	+\$0
CL	cool grey neutral	+\$0
LU	soft white	+\$0
WL	sandstone	+\$0
WN	warm grey neutral	+\$0

Linen Laminate Top/Thermoplastic Edge

For laminate (L)

LBM	crisp linen	+\$0
LBN	classic linen	+\$0
LBP	casual linen	+\$0

Mesh Laminate Top/Thermoplastic Edge

For laminate (L)

LBK	pewter mesh	+\$0
LBL	steel mesh	+\$0

Twill Laminate Top/Thermoplastic Edge

For laminate (L)

LBF	neutral twill	+\$0
LBG	sarum twill	+\$0
LBH	earthen twill	+\$0
LBJ	graphite twill	+\$0
LBQ	white twill	+\$0

Wood-Grain Laminate Top/Thermoplastic Edge

For laminate (L)

HM	natural maple	+\$0
HP	light anigre	+\$0
LBA	clear on ash	+\$0
LBR	phantom ecru	+\$0
LBS	phantom cocoa	+\$0
LBU	medium matte walnut	+\$0
LBV	warm grey teak	+\$0
LBB	oak on ash	+\$0
LBC	walnut on ash	+\$0
LBD	dark brown walnut	+\$0
LBE	medium red walnut	+\$0
76	light brown walnut	+\$0
HX	aged cherry	+\$0
HY	walnut on cherry	+\$0

Wood Veneer

For veneer (W)

2U	light brown walnut	+\$0
40	dark brown walnut	+\$0
ED	aged cherry	+\$0
EK	medium red walnut	+\$0
EW	medium matte walnut	+\$0
ET	clear on ash A	+\$0
EU	oak on ash A	+\$0
EV	walnut on ash A	+\$0
UL	natural maple	+\$0
UX	walnut on cherry	+\$0

Step 8. Top Cap Finish

Bright Sand Texture Paint

For painted standard top cap (P) or painted architectural top cap (A)

8Q	folkstone grey	+\$0
91	white	+\$0
98	studio white	+\$0
CL	cool grey neutral	+\$0
G1	graphite	+\$0
WL	sandstone	+\$0
WN	warm grey neutral	+\$0

Metallic Paint

For painted standard top cap (P) or painted architectural top cap (A)

CN	metallic champagne	+\$0
EH	metallic bronze	+\$0
MS	metallic silver	+\$0

Storage Cabinet, Frame Top,
 Mounted, Open *continued*

Canvas Office Landscape® Storage

Wood Veneer

For veneer standard top cap (W)

2U	light brown walnut	+\$0
40	dark brown walnut	+\$0
ED	aged cherry	+\$0
EK	medium red walnut	+\$0
EW	medium matte walnut	+\$0
UL	natural maple	+\$0
UX	walnut on cherry	+\$0

Step 9. Application

LD	stacking on 35", 46", 57" base frame	+\$0
JL	stacking on 42" or 53"-high base frame	+\$40

Tackboard, Storage Cabinet, Frame Top Mounted

FT491.

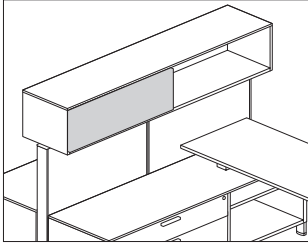

Product Information

Description

This tackboard attaches to 1 side of a double-sided frame top mounted storage cabinet to provide a tackable surface. Attachment hardware included.

Notes

Specify tackboard width $\frac{1}{2}$ the width of the storage cabinet.

Attaches to back of unit or to interior of open storage cabinet (FT415).

Tackboard accepts Customer's Own Material (COM). Yardage is estimated for directional, 54"-wide fabrics.

For tackable fabric option (T)

Width—Yardage

All widths— .61

For tackable fabric, horizontal (R)

Width—Yardage

18—.72

21—.80

24—.88

30—1.05

36—1.22

For information on multiple quantities or nondirectional fabrics, contact COM Department. See Order Information in Appendices.

Dimensions

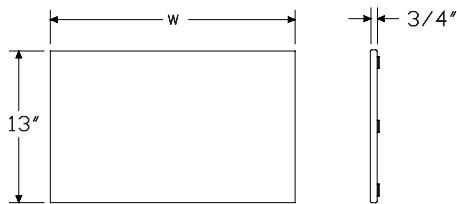

Specification Information

Step 1.

FT491. A

Step 2. Width

36 16 $\frac{3}{4}$ " for 36"-wide cabinet A

42 19 $\frac{3}{4}$ " for 42"-wide cabinet A

48 22 $\frac{3}{4}$ " for 48"-wide cabinet A

60 28 $\frac{3}{4}$ " for 60"-wide cabinet A

72 34 $\frac{3}{4}$ " for 72"-wide cabinet A

84 20" for 84"-wide cabinet A

96 23" for 96"-wide cabinet A

Step 3. Surface Material

T tackable fabric A

R tackable fabric, horizontal A

Prices for Steps 1-3.

	T	R
FT491. 36	\$129	132
42	\$146	150
48	\$164	169
60	\$190	195
72	\$218	224
84	\$146	150
96	\$164	169

Step 4. Surface Finish

See application chart and textiles list for fabric usage and numbers.

First 2 digits of number indicate fabric line; remaining digit(s) indicate fabric color.

Price Category 1	+\$0
Price Category 2	+\$19
Price Category 3	+\$33
Price Category 4	+\$51
Price Category 5	+\$103
Price Category B	+\$37
Price Category C	+\$51
Price Category D	+\$64
Price Category E	+\$78
Price Category F	+\$100
Price Category G	+\$130

Markerboard, Storage Cabinet, FT492.
Frame Top Mounted

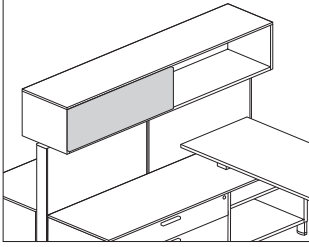

Canvas Office Landscape® Storage

Product Information

Description

This marker board attaches to 1 side of a double-sided frame top mounted storage cabinet to provide a writing surface for dry-erase markers. Attachment hardware included.

Notes

Specify marker board width $\frac{1}{2}$ the width of the storage cabinet.
Attaches to back of storage unit (FT415).

Dimensions

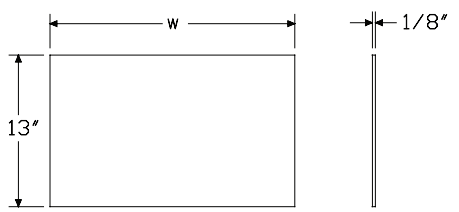

Specification Information

Step 1.

FT492. A

Step 2. Width

- 36** 16³/₄" for 36" -wide cabinet A
- 42** 19³/₄" for 42" -wide cabinet A
- 48** 22³/₄" for 48" -wide cabinet A
- 60** 28³/₄" for 60" -wide cabinet A
- 72** 34³/₄" for 72" -wide cabinet A
- 84** 20" for 84" -wide cabinet A
- 96** 23" for 96" -wide cabinet A

Prices for Steps 1-2.

FT492.	36	\$120
	42	\$126
	48	\$132
	60	\$147
	72	\$161
	84	\$126
	96	\$132

F-Style Sliding Door Storage Unit FT410.

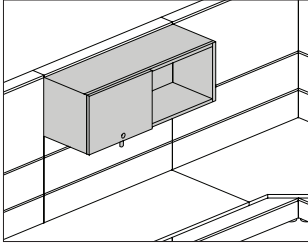

Product Information

Description

This lockable storage unit hangs from a frame, wall strips, off-module upper tile, or architectural wall. It has a painted, debossed, or veneer sliding door. The sliding door covers 1 side of the storage unit and can be locked in either position. The underside of the shelf accepts a task light. Attachment hardware included. Shipped knocked down.

The 15"-high storage unit has 1 shelf; the 22"-high storage unit has 2 shelves.

Notes

Debossed door can only be specified as lockable (L).

When hung off-module, the storage unit attaches in 1" intervals and can span more than 1 off-module upper tile.

When hung off-module, storage unit placement is determined by the location of off-module upper tile(s).

Order optional task light separately:

- Energy-efficient task light (G6120.)
- Performance task light (G6114.)
- Utility task light (G6136.)
- Twist™ LED task light (G6160.)

To enclose back of unit, order back panel (FT412.) separately. For off-module applications, a back panel is recommended.

Wall mount attachment includes back panel.

For keyed-alike locks, order chrome lock plugs separately. See Keyed-Alike Information in Appendices.

Dimensions

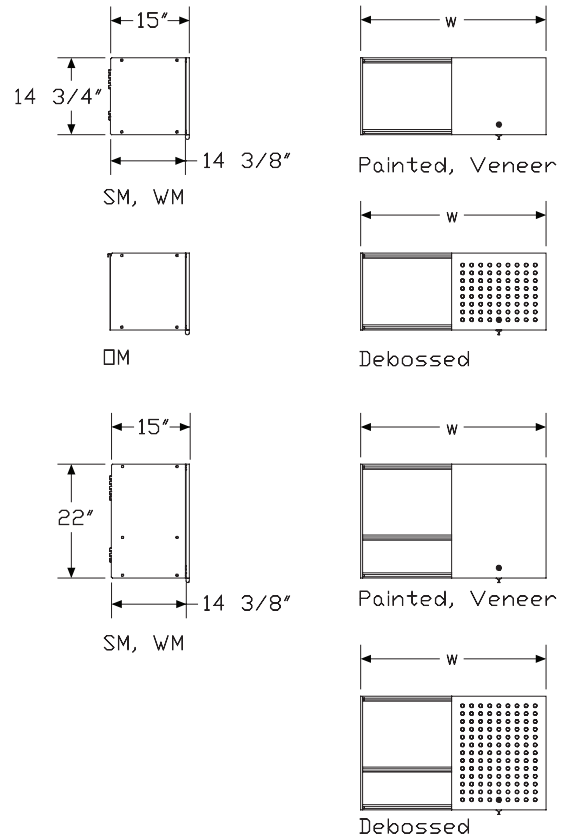

F-Style Sliding Door Storage Unit

continued

Canvas Office Landscape® Storage

Specification Information

Step 1.

FT410.

Step 2. Height

- 1** 15" high
- 2** 22" high

Step 3. Width

- 24** 24" wide
- 30** 30" wide
- 36** 36" wide
- 42** 42" wide
- 48** 48" wide

Step 4. Door Material

- P** painted door
- X** debossed door
- C** veneer door with vertical grain **A**

Step 5. Lock

For painted door (P) or veneer door with vertical grain (C)

- N** no lock
- L** lock

For debossed door (X)

- L** lock

Prices for Steps 1-5.

		PN	PL	XL	CN	CL
FT410. 1	24	\$364	377	403	508	523
	30	\$387	399	426	533	545
	36	\$419	429	462	568	578
	42	\$450	462	494	601	613
	48	\$476	489	525	630	642
2	24	\$487	498	523	668	682
	30	\$515	528	554	700	710
	36	\$556	567	597	742	754
	42	\$596	608	640	785	797
	48	\$625	638	675	819	831

Step 6. Lock Option

For lock (L)

- KA** keyed alike -\$10
- KC** keyed differently, chrome +\$0

Step 7. Case Finish

- 8Q** folkstone grey +\$0
- 98** studio white +\$0
- WL** sandstone +\$0

Bright Sand Texture Paint

- 91** white +\$0
- CL** cool grey neutral +\$0
- G1** graphite +\$0
- WN** warm grey neutral +\$0

Metallic Paint

- CN** metallic champagne +\$0
- EH** metallic bronze +\$0
- MS** metallic silver +\$0

Step 8. Door Finish

Sand Texture Paint

For painted door (P) or debossed door (X)

- 98** studio white +\$0
- 8Q** folkstone grey +\$0
- WL** sandstone +\$0

Bright Sand Texture Paint

For painted door (P) or debossed door (X)

- 91** white +\$0
- CL** cool grey neutral +\$0
- G1** graphite +\$0
- WN** warm grey neutral +\$0

Metallic Paint

For painted door (P) or debossed door (X)

- CN** metallic champagne +\$0
- EH** metallic bronze +\$0
- MS** metallic silver +\$0

F-Style Sliding Door Storage Unit

continued

Wood Veneer

For veneer door with vertical grain (C)

2U	light brown walnut <input type="checkbox"/> A	+\$55
40	dark brown walnut	+\$55
ED	aged cherry <input type="checkbox"/> A	+\$55
EK	medium red walnut	+\$55
EW	medium matte walnut	+\$55
ET	clear on ash <input type="checkbox"/> A	+\$55
EU	oak on ash <input type="checkbox"/> A	+\$55
EV	walnut on ash <input type="checkbox"/> A	+\$55
UL	natural maple <input type="checkbox"/> A	+\$55
UX	walnut on cherry <input type="checkbox"/> A	+\$55

Step 9. Pull Finish

91	white	+\$0
CL	cool grey neutral	+\$0
G1	graphite	+\$0
WN	warm grey neutral	+\$0

Step 10. End Panel Option

For 15" high (1)

OM	off module	+\$0
SM	on module	+\$0
WM	wall mount	+\$200

For 22" high (2)

SM	on module	+\$0
WM	wall mount	+\$200

F-Style Upmount Sliding Door Storage Unit

FT414.

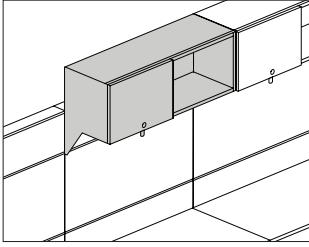

Canvas Office Landscape® Storage

Product Information

Description
 This 15"-high lockable storage unit has brackets that allow it to be mounted above the top of a frame. It has a painted, debossed, or veneer sliding door. The sliding door covers 1 side of the unit and can be locked in either position. The underside of the shelf accepts a task light. The back panel and attachment hardware included. Shipped knocked down.

Notes

Debossed door can only be specified as lockable (L).
 Order optional task light separately:

- Energy efficient task light (G6120.)
- Performance task light (G6114.)
- Utility task light (G6136.)
- Twist™ LED task light (G6160.)

For keyed-alike locks, specify chrome lock plugs separately. See Keyed-Alike information in Appendices.

Dimensions

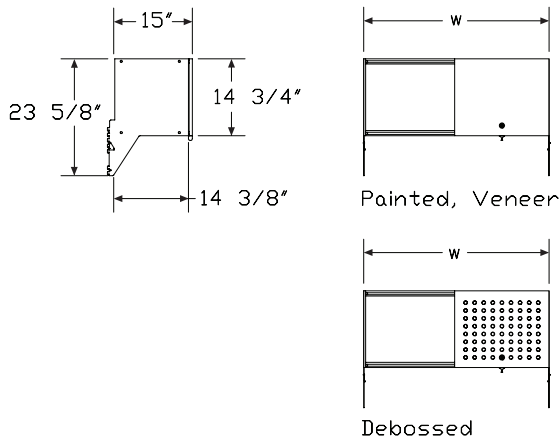

Specification Information

Step 1.

FT414.1

Step 2. Width

24	24" wide
30	30" wide
36	36" wide
42	42" wide
48	48" wide

Step 3. Door Material

P	painted door
X	debossed door
C	veneer door with vertical grain A

Step 4. Lock

For painted door (P) or veneer door with vertical grain (C)

N	no lock
L	lock

For debossed door (X)

L	lock
----------	------

Prices for Steps 1-4.

			N	L
FT414.1	24	P	\$557	569
		X	—	\$595
		C	\$714	727
	30	P	\$594	604
		X	—	\$633
		C	\$752	767
	36	P	\$634	644
		X	—	\$675
		C	\$798	810
	42	P	\$673	684
		X	—	\$717
		C	\$840	852
	48	P	\$713	725
		X	—	\$760
		C	\$884	897

Step 5. Lock Option

For lock (L)

KA	keyed alike	-\$10
KC	keyed differently, chrome	+\$0

F-Style Upmount Sliding Door Storage Unit *continued*

Step 6. Case Finish

8Q	folkstone grey	+\$0
98	studio white	+\$0
WL	sandstone	+\$0

Bright Sand Texture Paint

91	white	+\$0
CL	cool grey neutral	+\$0
G1	graphite	+\$0
LT	light tone <input type="checkbox"/> A	+\$0
WN	warm grey neutral	+\$0

Metallic Paint

CN	metallic champagne	+\$0
EH	metallic bronze	+\$0
MS	metallic silver	+\$0

Step 7. Door Finish

Sand Texture Paint

For painted door (P) or debossed door (X)

98	studio white	+\$0
8Q	folkstone grey	+\$0
WL	sandstone	+\$0

Bright Sand Texture Paint

For painted door (P) or debossed door (X)

91	white	+\$0
CL	cool grey neutral	+\$0
G1	graphite	+\$0
LT	light tone <input type="checkbox"/> A	+\$0
LU	soft white <input type="checkbox"/> A	+\$0
WN	warm grey neutral	+\$0

Metallic Paint

For painted door (P) or debossed door (X)

CN	metallic champagne	+\$0
EH	metallic bronze	+\$0
MS	metallic silver	+\$0

Wood Veneer

For veneer door with vertical grain (C)

2U	light brown walnut <input type="checkbox"/> A	+\$55
40	dark brown walnut	+\$55
ED	aged cherry <input type="checkbox"/> A	+\$55
EK	medium red walnut	+\$55
EW	medium matte walnut	+\$55
ET	clear on ash <input type="checkbox"/> A	+\$55
EU	oak on ash <input type="checkbox"/> A	+\$55
EV	walnut on ash <input type="checkbox"/> A	+\$55
UL	natural maple <input type="checkbox"/> A	+\$55
UX	walnut on cherry <input type="checkbox"/> A	+\$55

Step 8. Pull Finish

8Q	folkstone grey	+\$0
98	studio white	+\$0
WL	sandstone	+\$0
91	white	+\$0
CL	cool grey neutral	+\$0
G1	graphite	+\$0
WN	warm grey neutral	+\$0

F-Style Shelf

FT411.

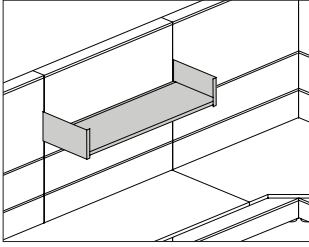

Product Information

Description

This 8³/₄"-high shelf hangs from a frame or wall strips. The underside of the shelf accepts a task light. Attachment hardware is included. Shipped knocked down.

Notes

Order optional task light separately:

- Energy-efficient task light (G6120.)
- Performance task light (G6114.)
- Utility task light (G6136.)
- Twist™ LED task light (G6160.)

Shelf matches style of sliding door storage unit (FT410.).

Dimensions

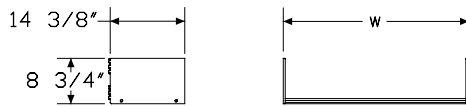

Specification Information

Step 1.

FT411.

Step 2. Width

24	24" wide
30	30" wide
36	36" wide
42	42" wide
48	48" wide

Prices for Steps 1-2.

FT411. 24	\$150
30	\$158
36	\$168
42	\$181
48	\$187

Step 3. Surface Finish

8Q	folkstone grey <input type="checkbox"/> A	+\$0
98	studio white <input type="checkbox"/> A	+\$0
WL	sandstone <input type="checkbox"/> A	+\$0

Bright Sand Texture Paint

91	white	+\$0
CL	cool grey neutral	+\$0
G1	graphite	+\$0
WN	warm grey neutral	+\$0

Metallic Paint

CN	metallic champagne	+\$0
EH	metallic bronze	+\$0
MS	metallic silver	+\$0

Step 4. End Panel Option

SM	on module	+\$0
-----------	-----------	------

F-Style Storage Unit Back Panel

FT412.

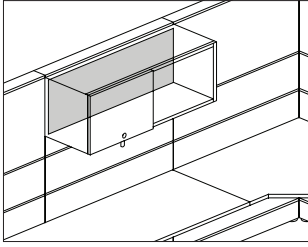

Product Information

Description

This panel attaches to the back of a sliding door storage unit to enclose the back. Attachment hardware is included.

Dimensions

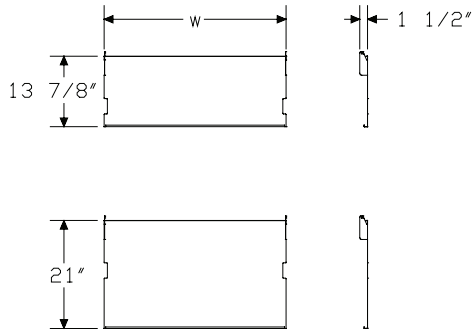

Specification Information

Step 1.

FT412.

Step 2. Height

- 15** 15" high
- 22** 22" high

Step 3. Width

- 24** 24" wide
- 30** 30" wide
- 36** 36" wide
- 42** 42" wide
- 48** 48" wide

Prices for Steps 1-3.

	24	30	36	42	48
FT412. 15	\$133	137	145	156	165
22	\$142	154	164	178	191

Step 4. Surface Finish

- 8Q** folkstone grey A +\$0
- 98** studio white A +\$0
- WL** sandstone A +\$0

Bright Sand Texture Paint

- 91** white +\$0
- CL** cool grey neutral +\$0
- G1** graphite +\$0
- WN** warm grey neutral +\$0

Metallic Paint

- CN** metallic champagne +\$0
- EH** metallic bronze +\$0
- MS** metallic silver +\$0

Overhead Storage Cabinet, Open FV43C.

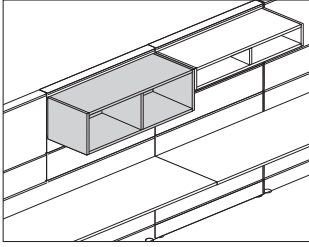

Canvas Office Landscape® Storage

Product Information

Description

This open cabinet hangs from a Canvas Wall frame or attaches to an architectural wall. It accepts a task light.

Notes

7"- or 15"-high cabinets at 24", 30", 36", 42", and 48"-wide have no divider.

7"- or 15"-high cabinets at 54", 60", 66", and 72"-wide have a center divider.

Matches style of overhead storage cabinet, hinged doors (FV43H).

Canvas frame connection option (F8) includes attachment hardware.

For wall mount option (WM), attachment hardware must be customer supplied. 54", 60", 66", and 72"-wide are wall mounted only.

Finished case top (WT) aligns to top of the bead on a Canvas tile.

3/8" thin top (o3, o4) aligns the top of the overhead to the top cap on a Canvas frame.

Grain direction is vertical on veneer and wood-grain laminate doors.

Grain direction is horizontal on laminate door units wider than 60".

Order optional task lights and accessories separately:

- Cable management clips (FT198.) - when cabinet is frame attached
- Cord manager (FV984.) - when cabinet is wall attached
- Performance task light (G6114.xxxxT)
- Utility task light (G6136.xxT)
- Twist LED task light (G6160.xB)
- Cast LED light(FV617.)

For additional product options, see Vary Easy Program in appendices.

Dimensions

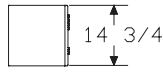
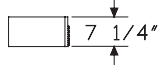
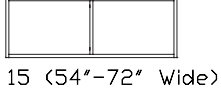
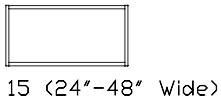
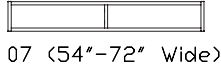
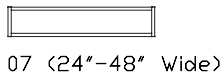
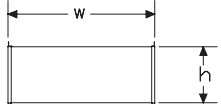

Overhead Storage Cabinet, Open

continued

Specification Information

Step 1.

FV43C.

Step 2. Attachment Bracket

F8 Canvas frame connection +\$100
WM wall mount +\$200

Step 3. Height

07 7½" high +\$150
15 15" high +\$300

Step 4. Width

For Canvas frame connection (F8)

24 24" wide +\$325
30 30" wide +\$355
36 36" wide +\$425
42 42" wide +\$455
48 48" wide +\$475

For wall mount (WM)

24 24" wide +\$325
30 30" wide +\$355
36 36" wide +\$425
42 42" wide +\$455
48 48" wide +\$475
54 54" wide +\$550
60 60" wide +\$600
66 66" wide +\$675
72 72" wide +\$810

Step 5. Case Material

For 24" wide (24), 30" wide (30), or 36" wide (36)

L laminate +\$0
W veneer +\$900

For 42" wide (42), 48" wide (48), or 54" wide (54)

L laminate +\$0
W veneer +\$975

For 60" wide (60) or 66" wide (66)

L laminate +\$0
W veneer +\$1025

For 72" wide (72)

L laminate +\$0
W veneer +\$1350

Step 6. Top

WT finished case top +\$0
03 ¾" laminate thin top +\$150
04 ¾" veneer thin top +\$300
NT no top for use with ¾" common thin top +\$50

Step 7. Case/Edge Finish

For laminate (L)

76 light brown walnut +\$0
8Q folkstone grey +\$0
91 white +\$0
98 studio white +\$0
CL cool grey neutral +\$0
HM natural maple +\$0
HP light anigre +\$0
HX aged cherry +\$0
HY walnut on cherry +\$0
LA light ash +\$0
LBA clear on ash +\$0
LBR phantom ecru +\$0
LBS phantom cocoa +\$0
LBU medium matte walnut +\$0
LBV warm grey teak +\$0
LBB oak on ash +\$0
LBC walnut on ash +\$0
LBD dark brown walnut +\$0
LBE medium red walnut +\$0
LBF neutral twill +\$0
LBG sarum twill +\$0
LBH earthen twill +\$0
LBJ graphite twill +\$0
LBK pewter mesh +\$0
LBL steel mesh +\$0
LBM crisp linen +\$0
LBN classic linen +\$0
LBP casual linen +\$0
LBQ white twill +\$0
LU soft white +\$0
WL sandstone +\$0
WN warm grey neutral +\$0

Overhead Storage Cabinet, Open

continued

Canvas Office Landscape® Storage

Wood Veneer Case/Edge

For veneer (W)

2U	light brown walnut <input type="checkbox"/>	+\$0
40	dark brown walnut <input type="checkbox"/>	+\$0
ED	aged cherry <input type="checkbox"/>	+\$0
EK	medium red walnut <input type="checkbox"/>	+\$0
EW	medium matte walnut <input type="checkbox"/>	+\$0
ET	clear on ash <input type="checkbox"/>	+\$0
EU	oak on ash <input type="checkbox"/>	+\$0
EV	walnut on ash <input type="checkbox"/>	+\$0
UL	natural maple <input type="checkbox"/>	+\$0
UX	walnut on cherry <input type="checkbox"/>	+\$0

Step 8. Top/Edge Finish

For ³/₈" laminate thin top (O3)

76	light brown walnut <input type="checkbox"/>	+\$0
8Q	folkstone grey <input type="checkbox"/>	+\$0
91	white <input type="checkbox"/>	+\$0
98	studio white <input type="checkbox"/>	+\$0
CL	cool grey neutral <input type="checkbox"/>	+\$0
HM	natural maple <input type="checkbox"/>	+\$0
HP	light anigre <input type="checkbox"/>	+\$0
HX	aged cherry <input type="checkbox"/>	+\$0
HY	walnut on cherry <input type="checkbox"/>	+\$0
LA	light ash <input type="checkbox"/>	+\$0
LBA	clear on ash <input type="checkbox"/>	+\$0
LBR	phantom ecru <input type="checkbox"/>	+\$0
LBS	phantom cocoa <input type="checkbox"/>	+\$0
LBU	medium matte walnut <input type="checkbox"/>	+\$0
LBV	warm grey teak <input type="checkbox"/>	+\$0
LBB	oak on ash <input type="checkbox"/>	+\$0
LBC	walnut on ash <input type="checkbox"/>	+\$0
LBD	dark brown walnut <input type="checkbox"/>	+\$0
LBE	medium red walnut <input type="checkbox"/>	+\$0
LBF	neutral twill <input type="checkbox"/>	+\$0
LBG	sarum twill <input type="checkbox"/>	+\$0
LBH	earthen twill <input type="checkbox"/>	+\$0
LBJ	graphite twill <input type="checkbox"/>	+\$0
LBK	pewter mesh <input type="checkbox"/>	+\$0
LBL	steel mesh <input type="checkbox"/>	+\$0
LBM	crisp linen <input type="checkbox"/>	+\$0
LBN	classic linen <input type="checkbox"/>	+\$0
LBP	casual linen <input type="checkbox"/>	+\$0
LBQ	white twill <input type="checkbox"/>	+\$0
LU	soft white <input type="checkbox"/>	+\$0
WL	sandstone <input type="checkbox"/>	+\$0
WN	warm grey neutral <input type="checkbox"/>	+\$0

Overhead Storage Cabinet, Open

continued

Wood Veneer Top/Edge

For $\frac{3}{8}$ " veneer thin top (04)

2U	light brown walnut <input type="checkbox"/> A	+\$0
40	dark brown walnut <input type="checkbox"/> A	+\$0
ED	aged cherry <input type="checkbox"/> A	+\$0
EK	medium red walnut <input type="checkbox"/> A	+\$0
EW	medium matte walnut <input type="checkbox"/> A	+\$0
ET	clear on ash <input type="checkbox"/> A	+\$0
EU	oak on ash <input type="checkbox"/> A	+\$0
EV	walnut on ash <input type="checkbox"/> A	+\$0
UL	natural maple <input type="checkbox"/> A	+\$0
UX	walnut on cherry <input type="checkbox"/> A	+\$0

Overhead Storage Cabinet, Hinged Doors

FV43H.

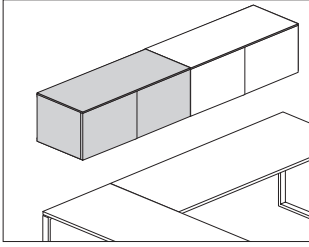

Product Information

Description

This cabinet hangs from a Canvas Wall frame or attaches to an architectural wall to provide fully enclosed storage or enclosed storage with an open shelf below. It accepts a task light.

Notes

15"-high cabinet is fully enclosed. 22"-high cabinet has an open shelf below the doors.

Matches style of overhead storage cabinet, open (FV43C).

Cabinets up to 48" wide have 2 doors. 54", 60", 66", and 72"-wide cabinets have 4 doors.

Canvas frame connection option (F8) includes attachment hardware.

For wall mount option (WM), attachment hardware must be customer supplied. 54", 60", 66", and 72"-wide are wall mounted only.

Finished case top (WT) aligns to top of the bead on a Canvas tile.

3/8" thin top (o3, o4) aligns the top of the overhead to the top cap on a Canvas frame.

Glass doors are back-painted and writable with dry erase markers.

Doors are nonmagnetic.

Glass doors cannot lock.

Grain direction is vertical on veneer and wood-grain laminate doors.

Grain direction is horizontal on laminate door units wider than 60".

Order optional task lights and accessories separately:

- Cable management clips (FT198.) - when cabinet is frame attached
- Cord manager (FV984.) - when cabinet is wall attached
- Performance task light (G6114.xxxxT)
- Utility task light (G6136.xxT)
- Twist LED task light (G6160.xB)
- Cast LED light (FV617.)

For keyed-alike locks, see Keyed-Alike Information in appendices.

For additional product options, see Vary Easy Program in appendices.

Dimensions

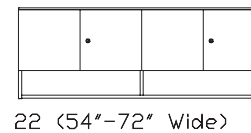
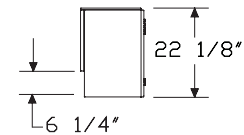
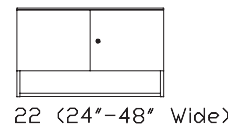
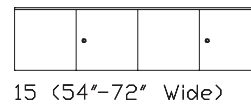
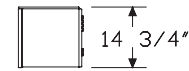
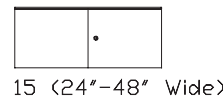
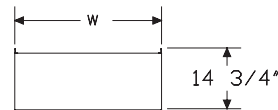

Overhead Storage Cabinet, Hinged Doors *continued*

Specification Information

Step 1.

FV43H. A

Step 2. Attachment Bracket

F8 Canvas frame connection A +\$100
WM wall mount A +\$200

Step 3. Height

15 15" high A +\$300
22 22" high A +\$500

Step 4. Width

For Canvas frame connection (F8)

24 24" wide A +\$325
30 30" wide A +\$355
36 36" wide A +\$425
42 42" wide A +\$455
48 48" wide A +\$475

For wall mount (WM)

24 24" wide A +\$325
30 30" wide A +\$355
36 36" wide A +\$425
42 42" wide A +\$455
48 48" wide A +\$475
54 54" wide A +\$550
60 60" wide A +\$600
66 66" wide A +\$675
72 72" wide A +\$810

Step 5. Case/Door Material

For 24" wide (24), 30" wide (30), or 36" wide (36)

L laminate case and doors A +\$350
C laminate case/veneer doors A +\$600
W veneer case and doors A +\$1800
G laminate case/glass doors A +\$1650
R veneer case/glass doors A +\$2570

For 42" wide (42), 48" wide (48), or 54" wide (54)

L laminate case and doors A +\$375
C laminate case/veneer doors A +\$650
W veneer case and doors A +\$1950
G laminate case/glass doors A +\$1800
R veneer case/glass doors A +\$2800

For 60" wide (60) or 66" wide (66)

L laminate case and doors A +\$600
C laminate case/veneer doors A +\$1000
W veneer case and doors A +\$2700
G laminate case/glass doors A +\$2550
R veneer case/glass doors A +\$4000

For 72" wide (72)

L laminate case and doors A +\$650
C laminate case/veneer doors A +\$1050
W veneer case and doors A +\$2900
G laminate case/glass doors A +\$2750
R veneer case/glass doors A +\$4275

Step 6. Top

WT finished case top A +\$0
03 3/8" laminate thin top A +\$150
04 3/8" veneer thin top A +\$300
NT no top for use with 3/8" common thin top A +\$50

Step 7. Lock

For laminate case and doors (L), laminate case/veneer doors (C), or veneer case and doors (W)

L lock A +\$0
N no lock A +\$0

For laminate case/glass doors (G) or veneer case/glass doors (R)

N no lock A +\$0

Step 8. Lock Option

For lock (L)

KA keyed alike A -\$10
KC keyed differently, chrome A +\$0
KD keyed differently, black A +\$0

Overhead Storage Cabinet, Hinged Doors *continued*

Step 9. Case/Edge Finish

For laminate case and doors (L), laminate case/veneer doors (C), or laminate case/glass doors (G)

76	light brown walnut <input type="checkbox"/>	+\$0
8Q	folkstone grey <input type="checkbox"/>	+\$0
91	white <input type="checkbox"/>	+\$0
98	studio white <input type="checkbox"/>	+\$0
CL	cool grey neutral <input type="checkbox"/>	+\$0
HM	natural maple <input type="checkbox"/>	+\$0
HP	light anigre <input type="checkbox"/>	+\$0
HX	aged cherry <input type="checkbox"/>	+\$0
HY	walnut on cherry <input type="checkbox"/>	+\$0
LA	light ash <input type="checkbox"/>	+\$0
LBA	clear on ash <input type="checkbox"/>	+\$0
LBR	phantom ecru <input type="checkbox"/>	+\$0
LBS	phantom cocoa <input type="checkbox"/>	+\$0
LBU	medium matte walnut <input type="checkbox"/>	+\$0
LBV	warm grey teak <input type="checkbox"/>	+\$0
LBB	oak on ash <input type="checkbox"/>	+\$0
LBC	walnut on ash <input type="checkbox"/>	+\$0
LBD	dark brown walnut <input type="checkbox"/>	+\$0
LBE	medium red walnut <input type="checkbox"/>	+\$0
LBF	neutral twill <input type="checkbox"/>	+\$0
LBG	sarum twill <input type="checkbox"/>	+\$0
LBH	earthen twill <input type="checkbox"/>	+\$0
LBJ	graphite twill <input type="checkbox"/>	+\$0
LBK	pewter mesh <input type="checkbox"/>	+\$0
LBL	steel mesh <input type="checkbox"/>	+\$0
LBM	crisp linen <input type="checkbox"/>	+\$0
LBN	classic linen <input type="checkbox"/>	+\$0
LBP	casual linen <input type="checkbox"/>	+\$0
LBQ	white twill <input type="checkbox"/>	+\$0
LU	soft white <input type="checkbox"/>	+\$0
WL	sandstone <input type="checkbox"/>	+\$0
WN	warm grey neutral <input type="checkbox"/>	+\$0

Wood Veneer Case/Edge

For veneer case and doors (W) or veneer case/glass doors (R)

2U	light brown walnut <input type="checkbox"/>	+\$0
40	dark brown walnut <input type="checkbox"/>	+\$0
ED	aged cherry <input type="checkbox"/>	+\$0
EK	medium red walnut <input type="checkbox"/>	+\$0
EW	medium matte walnut <input type="checkbox"/>	+\$0
ET	clear on ash <input type="checkbox"/>	+\$0
EU	oak on ash <input type="checkbox"/>	+\$0
EV	walnut on ash <input type="checkbox"/>	+\$0
UL	natural maple <input type="checkbox"/>	+\$0
UX	walnut on cherry <input type="checkbox"/>	+\$0

Overhead Storage Cabinet, Hinged Doors *continued*

Step 10. Door/Edge Finish

For laminate case and doors (L)

76	light brown walnut <input type="checkbox"/>	+\$0
8Q	folkstone grey <input type="checkbox"/>	+\$0
91	white <input type="checkbox"/>	+\$0
98	studio white <input type="checkbox"/>	+\$0
CL	cool grey neutral <input type="checkbox"/>	+\$0
HM	natural maple <input type="checkbox"/>	+\$0
HP	light anigre <input type="checkbox"/>	+\$0
HX	aged cherry <input type="checkbox"/>	+\$0
HY	walnut on cherry <input type="checkbox"/>	+\$0
LA	light ash <input type="checkbox"/>	+\$0
LBA	clear on ash <input type="checkbox"/>	+\$0
LBR	phantom ecru <input type="checkbox"/>	+\$0
LBS	phantom cocoa <input type="checkbox"/>	+\$0
LBU	medium matte walnut <input type="checkbox"/>	+\$0
LBV	warm grey teak <input type="checkbox"/>	+\$0
LBB	oak on ash <input type="checkbox"/>	+\$0
LBC	walnut on ash <input type="checkbox"/>	+\$0
LBD	dark brown walnut <input type="checkbox"/>	+\$0
LBE	medium red walnut <input type="checkbox"/>	+\$0
LBF	neutral twill <input type="checkbox"/>	+\$0
LBG	sarum twill <input type="checkbox"/>	+\$0
LBH	earthen twill <input type="checkbox"/>	+\$0
LBJ	graphite twill <input type="checkbox"/>	+\$0
LBK	pewter mesh <input type="checkbox"/>	+\$0
LBL	steel mesh <input type="checkbox"/>	+\$0
LBM	crisp linen <input type="checkbox"/>	+\$0
LBN	classic linen <input type="checkbox"/>	+\$0
LBP	casual linen <input type="checkbox"/>	+\$0
LBQ	white twill <input type="checkbox"/>	+\$0
LU	soft white <input type="checkbox"/>	+\$0
WL	sandstone <input type="checkbox"/>	+\$0
WN	warm grey neutral <input type="checkbox"/>	+\$0

Wood Veneer Door Edge

For laminate case/veneer doors (C) or veneer case and doors (W)

2U	light brown walnut <input type="checkbox"/>	+\$0
40	dark brown walnut <input type="checkbox"/>	+\$0
ED	aged cherry <input type="checkbox"/>	+\$0
EK	medium red walnut <input type="checkbox"/>	+\$0
EW	medium matte walnut <input type="checkbox"/>	+\$0
ET	clear on ash <input type="checkbox"/>	+\$0
EU	oak on ash <input type="checkbox"/>	+\$0
EV	walnut on ash <input type="checkbox"/>	+\$0
UL	natural maple <input type="checkbox"/>	+\$0
UX	walnut on cherry <input type="checkbox"/>	+\$0

For laminate case/glass doors (G) or veneer case/glass doors (R)

8Q	folkstone grey <input type="checkbox"/>	+\$0
91	white <input type="checkbox"/>	+\$0
98	studio white <input type="checkbox"/>	+\$0

Overhead Storage Cabinet, Hinged Doors *continued*

Step 11. Top/Edge Finish

For 3/8" laminate thin top (03)

76	light brown walnut <input type="checkbox"/>	+\$0
8Q	folkstone grey <input type="checkbox"/>	+\$0
91	white <input type="checkbox"/>	+\$0
98	studio white <input type="checkbox"/>	+\$0
CL	cool grey neutral <input type="checkbox"/>	+\$0
HM	natural maple <input type="checkbox"/>	+\$0
HP	light anigre <input type="checkbox"/>	+\$0
HX	aged cherry <input type="checkbox"/>	+\$0
HY	walnut on cherry <input type="checkbox"/>	+\$0
LA	light ash <input type="checkbox"/>	+\$0
LBA	clear on ash <input type="checkbox"/>	+\$0
LBR	phantom ecru <input type="checkbox"/>	+\$0
LBS	phantom cocoa <input type="checkbox"/>	+\$0
LBU	medium matte walnut <input type="checkbox"/>	+\$0
LBV	warm grey teak <input type="checkbox"/>	+\$0
LBB	oak on ash <input type="checkbox"/>	+\$0
LBC	walnut on ash <input type="checkbox"/>	+\$0
LBD	dark brown walnut <input type="checkbox"/>	+\$0
LBE	medium red walnut <input type="checkbox"/>	+\$0
LBF	neutral twill <input type="checkbox"/>	+\$0
LBG	sarum twill <input type="checkbox"/>	+\$0
LBH	earthen twill <input type="checkbox"/>	+\$0
LBJ	graphite twill <input type="checkbox"/>	+\$0
LBK	pewter mesh <input type="checkbox"/>	+\$0
LBL	steel mesh <input type="checkbox"/>	+\$0
LBM	crisp linen <input type="checkbox"/>	+\$0
LBN	classic linen <input type="checkbox"/>	+\$0
LBP	casual linen <input type="checkbox"/>	+\$0
LBQ	white twill <input type="checkbox"/>	+\$0
LU	soft white <input type="checkbox"/>	+\$0
WL	sandstone <input type="checkbox"/>	+\$0
WN	warm grey neutral <input type="checkbox"/>	+\$0

Wood Veneer Top/Edge

For 3/8" veneer thin top (04)

2U	light brown walnut <input type="checkbox"/>	+\$0
40	dark brown walnut <input type="checkbox"/>	+\$0
ED	aged cherry <input type="checkbox"/>	+\$0
EK	medium red walnut <input type="checkbox"/>	+\$0
EW	medium matte walnut <input type="checkbox"/>	+\$0
ET	clear on ash <input type="checkbox"/>	+\$0
EU	oak on ash <input type="checkbox"/>	+\$0
EV	walnut on ash <input type="checkbox"/>	+\$0
UL	natural maple <input type="checkbox"/>	+\$0
UX	walnut on cherry <input type="checkbox"/>	+\$0

Overhead Storage Cabinet, Sliding Partial Enclosure

FV43P.

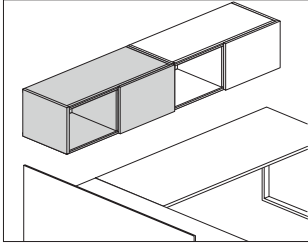

Product Information

Description

This cabinet hangs from a Canvas Wall frame or attaches to an architectural wall and provides partially enclosed storage. The sliding door with optional lock encloses 1 side of the cabinet and can be locked on either side. The cabinet accepts a task light.

Notes

Matches style of overhead storage cabinet, sliding full enclosure (FV43F).

Cabinets up to 60" wide have 1 door. 66"- and 72"-wide cabinets have 2 doors.

Cabinets up to 60" wide have a center divider. 66"-wide cabinet has 2 dividers and is divided as 1/3, 1/3, 1/3. 72"-wide cabinet has 2 dividers and is divided as 1/4, 1/2, 1/4.

Canvas frame connection option (F8) includes attachment hardware.

For wall mount option (WM), attachment hardware must be customer supplied. 54", 60", 66", and 72"-wide are wall mounted only.

Overhead case top aligns with top of the bead on a Canvas tile.

Sliding door sits proud of overhead.

Grain direction is vertical on veneer and wood-grain laminate doors.

Grain direction is horizontal on laminate door units wider than 60".

Order optional task lights and accessories separately:

- Cable management clips (FT198.) - when cabinet is frame attached
- Cord manager (FV984.) - when cabinet is wall attached
- Performance task light (G6114.xxxxT)
- Utility task light (G6136.xxT)
- Twist LED task light (G6160.xB)
- Cast LED light(FV617.)

For keyed-alike locks, see Keyed-Alike Information in appendices.

For additional product options, see Vary Easy Program in appendices.

Dimensions

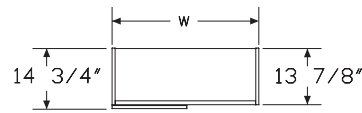

07 (24"-60" Wide)

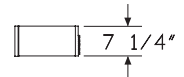

15 (24"-60" Wide)

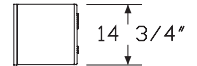

07 (66" Wide)



15 (66" Wide)



07 (72" Wide)



15 (72" Wide)

Overhead Storage Cabinet, Sliding Partial Enclosure *continued*

Specification Information		
Step 1.		
FV43P.	<input type="checkbox"/> A	
Step 2. Attachment Bracket		
F8	Canvas frame connection <input type="checkbox"/> A	+\$100
WM	wall mount <input type="checkbox"/> A	+\$200
Step 3. Height		
07	7½" high <input type="checkbox"/> A	+\$150
15	15" high <input type="checkbox"/> A	+\$300
Step 4. Width		
<i>For Canvas frame connection (F8)</i>		
24	24" wide <input type="checkbox"/> A	+\$325
30	30" wide <input type="checkbox"/> A	+\$355
36	36" wide <input type="checkbox"/> A	+\$425
42	42" wide <input type="checkbox"/> A	+\$455
48	48" wide <input type="checkbox"/> A	+\$475
<i>For wall mount (WM) with 7½" high (07)</i>		
24	24" wide <input type="checkbox"/> A	+\$325
30	30" wide <input type="checkbox"/> A	+\$355
36	36" wide <input type="checkbox"/> A	+\$425
42	42" wide <input type="checkbox"/> A	+\$455
48	48" wide <input type="checkbox"/> A	+\$475
<i>For wall mount (WM) with 15" high (15)</i>		
24	24" wide <input type="checkbox"/> A	+\$325
30	30" wide <input type="checkbox"/> A	+\$355
36	36" wide <input type="checkbox"/> A	+\$425
42	42" wide <input type="checkbox"/> A	+\$455
48	48" wide <input type="checkbox"/> A	+\$475
54	54" wide <input type="checkbox"/> A	+\$550
60	60" wide <input type="checkbox"/> A	+\$600
66	66" wide <input type="checkbox"/> A	+\$675
72	72" wide <input type="checkbox"/> A	+\$810
Step 5. Case/Door Material		
<i>For 24" wide (24), 30" wide (30), or 36" wide (36)</i>		
L	laminated case and doors <input type="checkbox"/> A	+\$250
C	laminated case/veneer doors <input type="checkbox"/> A	+\$500
W	veneer case and doors <input type="checkbox"/> A	+\$1250

<i>For 42" wide (42), 48" wide (48), or 54" wide (54)</i>		
L	laminated case and doors <input type="checkbox"/> A	+\$400
C	laminated case/veneer doors <input type="checkbox"/> A	+\$600
W	veneer case and doors <input type="checkbox"/> A	+\$1400
<i>For 60" wide (60) or 66" wide (66)</i>		
L	laminated case and doors <input type="checkbox"/> A	+\$625
C	laminated case/veneer doors <input type="checkbox"/> A	+\$700
W	veneer case and doors <input type="checkbox"/> A	+\$2250
<i>For 72" wide (72)</i>		
L	laminated case and doors <input type="checkbox"/> A	+\$650
C	laminated case/veneer doors <input type="checkbox"/> A	+\$800
W	veneer case and doors <input type="checkbox"/> A	+\$2300
Step 6. Lock		
L	lock <input type="checkbox"/> A	+\$0
N	no lock <input type="checkbox"/> A	+\$0
Step 7. Lock Option		
<i>For lock (L)</i>		
KA	keyed alike <input type="checkbox"/> A	-\$10
KC	keyed differently, chrome <input type="checkbox"/> A	+\$0
KD	keyed differently, black <input type="checkbox"/> A	+\$0

Overhead Storage Cabinet, Sliding Partial Enclosure *continued*

Step 8. Case/Edge Finish

For laminate case and doors (L) or laminate case/veneer doors (C)

76	light brown walnut <input type="checkbox"/>	+\$0
8Q	folkstone grey <input type="checkbox"/>	+\$0
91	white <input type="checkbox"/>	+\$0
98	studio white <input type="checkbox"/>	+\$0
CL	cool grey neutral <input type="checkbox"/>	+\$0
HM	natural maple <input type="checkbox"/>	+\$0
HP	light anigre <input type="checkbox"/>	+\$0
HX	aged cherry <input type="checkbox"/>	+\$0
HY	walnut on cherry <input type="checkbox"/>	+\$0
LA	light ash <input type="checkbox"/>	+\$0
LBA	clear on ash <input type="checkbox"/>	+\$0
LBR	phantom ecru <input type="checkbox"/>	+\$0
LBS	phantom cocoa <input type="checkbox"/>	+\$0
LBU	medium matte walnut <input type="checkbox"/>	+\$0
LBV	warm grey teak <input type="checkbox"/>	+\$0
LBB	oak on ash <input type="checkbox"/>	+\$0
LBC	walnut on ash <input type="checkbox"/>	+\$0
LBD	dark brown walnut <input type="checkbox"/>	+\$0
LBE	medium red walnut <input type="checkbox"/>	+\$0
LBF	neutral twill <input type="checkbox"/>	+\$0
LBG	sarum twill <input type="checkbox"/>	+\$0
LBH	earthen twill <input type="checkbox"/>	+\$0
LBJ	graphite twill <input type="checkbox"/>	+\$0
LBK	pewter mesh <input type="checkbox"/>	+\$0
LBL	steel mesh <input type="checkbox"/>	+\$0
LBM	crisp linen <input type="checkbox"/>	+\$0
LBN	classic linen <input type="checkbox"/>	+\$0
LBP	casual linen <input type="checkbox"/>	+\$0
LBQ	white twill <input type="checkbox"/>	+\$0
LU	soft white <input type="checkbox"/>	+\$0
WL	sandstone <input type="checkbox"/>	+\$0
WN	warm grey neutral <input type="checkbox"/>	+\$0

Wood Veneer Case/Edge

For veneer case and doors (W)

2U	light brown walnut <input type="checkbox"/>	+\$0
40	dark brown walnut <input type="checkbox"/>	+\$0
ED	aged cherry <input type="checkbox"/>	+\$0
EK	medium red walnut <input type="checkbox"/>	+\$0
EW	medium matte walnut <input type="checkbox"/>	+\$0
ET	clear on ash <input type="checkbox"/>	+\$0
EU	oak on ash <input type="checkbox"/>	+\$0
EV	walnut on ash <input type="checkbox"/>	+\$0
UL	natural maple <input type="checkbox"/>	+\$0
UX	walnut on cherry <input type="checkbox"/>	+\$0

Overhead Storage Cabinet, Sliding Partial Enclosure *continued*

Step 9. Door/Edge Finish

For laminate case and doors (L)

76	light brown walnut <input type="checkbox"/>	+\$0
8Q	folkstone grey <input type="checkbox"/>	+\$0
91	white <input type="checkbox"/>	+\$0
98	studio white <input type="checkbox"/>	+\$0
CL	cool grey neutral <input type="checkbox"/>	+\$0
HM	natural maple <input type="checkbox"/>	+\$0
HP	light anigre <input type="checkbox"/>	+\$0
HX	aged cherry <input type="checkbox"/>	+\$0
HY	walnut on cherry <input type="checkbox"/>	+\$0
LA	light ash <input type="checkbox"/>	+\$0
LBA	clear on ash <input type="checkbox"/>	+\$0
LBR	phantom ecru <input type="checkbox"/>	+\$0
LBS	phantom cocoa <input type="checkbox"/>	+\$0
LBU	medium matte walnut <input type="checkbox"/>	+\$0
LBV	warm grey teak <input type="checkbox"/>	+\$0
LBB	oak on ash <input type="checkbox"/>	+\$0
LBC	walnut on ash <input type="checkbox"/>	+\$0
LBD	dark brown walnut <input type="checkbox"/>	+\$0
LBE	medium red walnut <input type="checkbox"/>	+\$0
LBF	neutral twill <input type="checkbox"/>	+\$0
LBG	sarum twill <input type="checkbox"/>	+\$0
LBH	earthen twill <input type="checkbox"/>	+\$0
LBJ	graphite twill <input type="checkbox"/>	+\$0
LBK	pewter mesh <input type="checkbox"/>	+\$0
LBL	steel mesh <input type="checkbox"/>	+\$0
LBM	crisp linen <input type="checkbox"/>	+\$0
LBN	classic linen <input type="checkbox"/>	+\$0
LBP	casual linen <input type="checkbox"/>	+\$0
LBQ	white twill <input type="checkbox"/>	+\$0
LU	soft white <input type="checkbox"/>	+\$0
WL	sandstone <input type="checkbox"/>	+\$0
WN	warm grey neutral <input type="checkbox"/>	+\$0

Wood Veneer Door Edge

For laminate case/veneer doors (C) or veneer case and doors (W)

2U	light brown walnut <input type="checkbox"/>	+\$0
40	dark brown walnut <input type="checkbox"/>	+\$0
ED	aged cherry <input type="checkbox"/>	+\$0
EK	medium red walnut <input type="checkbox"/>	+\$0
EW	medium matte walnut <input type="checkbox"/>	+\$0
ET	clear on ash <input type="checkbox"/>	+\$0
EU	oak on ash <input type="checkbox"/>	+\$0
EV	walnut on ash <input type="checkbox"/>	+\$0
UL	natural maple <input type="checkbox"/>	+\$0
UX	walnut on cherry <input type="checkbox"/>	+\$0

Overhead Storage Cabinet, Sliding Full Enclosure

FV43F.

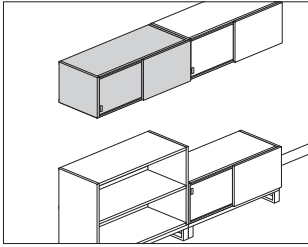

Product Information

Description

This cabinet mounts to a Canvas Wall frame or attaches to an architectural wall and provides fully enclosed storage. It has 2 types of sliding doors; a solid primary door with an optional lock encloses 1 side, and a painted or translucent secondary door encloses the other side. Both doors can slide the entire width of the cabinet. The primary door can be locked on either side. Secondary door handle finish is anodized aluminum. The cabinet accepts a task light.

Notes

Matches style of overhead storage cabinet, sliding partial enclosure (FV43P.).

Cabinets up to 60" wide have 1 primary and 1 secondary door. 66"-wide cabinet has 2 primary doors and 1 secondary door. 72"-wide cabinet has 2 primary and 2 secondary doors.

Cabinets up to 60" wide have a center divider. 66"-wide cabinet has 2 dividers and is divided as 1/3, 1/3, 1/3. 72"-wide cabinet has 2 dividers and is divided as 1/4, 1/2, 1/4.

Canvas frame connection option (F8) includes attachment hardware.

For wall mount option (WM), attachment hardware must be customer supplied. 54", 60", 66", and 72"-wide are wall mounted only.

Overhead case top aligns with top of the bead on a Canvas tile.

Sliding door sits proud of overhead.

Grain direction is vertical on veneer and wood-grain laminate doors.

Grain direction is horizontal on laminate door units wider than 60".

Order optional task lights and accessories separately:

- Cable management clips (FT198.) - when cabinet is frame attached.
- Cord manager (FV984.) - when cabinet is wall attached
- Performance task light (G6114.xxxT)
- Utility task light (G6136.xxT)
- Twist LED task light (G6160.xB)
- Cast LED light(FV617.)

For keyed-alike locks, see Keyed-Alike Information in Appendices.

For additional product options, see Vary Easy Program in Appendices.

Dimensions

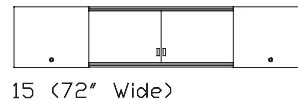
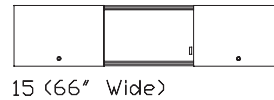
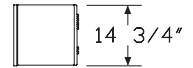
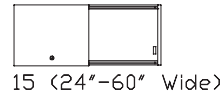
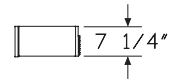
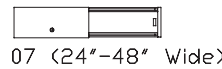
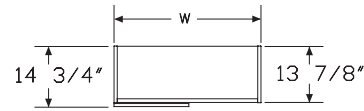

Overhead Storage Cabinet, Sliding Full Enclosure *continued*

Specification Information		
Step 1.		
FV43F.	<input type="checkbox"/> A	
Step 2. Attachment Bracket		
F8	Canvas frame connection <input type="checkbox"/> A	+\$100
WM	wall mount <input type="checkbox"/> A	+\$200
Step 3. Height		
07	7½" high <input type="checkbox"/> A	+\$150
15	15" high <input type="checkbox"/> A	+\$300
Step 4. Width		
<i>For Canvas frame connection (F8)</i>		
24	24" wide <input type="checkbox"/> A	+\$325
30	30" wide <input type="checkbox"/> A	+\$355
36	36" wide <input type="checkbox"/> A	+\$425
42	42" wide <input type="checkbox"/> A	+\$455
48	48" wide <input type="checkbox"/> A	+\$475
<i>For wall mount (WM) with 7½" high (07)</i>		
24	24" wide <input type="checkbox"/> A	+\$325
30	30" wide <input type="checkbox"/> A	+\$355
36	36" wide <input type="checkbox"/> A	+\$425
42	42" wide <input type="checkbox"/> A	+\$455
48	48" wide <input type="checkbox"/> A	+\$475
<i>For wall mount (WM) with 15" high (15)</i>		
24	24" wide <input type="checkbox"/> A	+\$325
30	30" wide <input type="checkbox"/> A	+\$355
36	36" wide <input type="checkbox"/> A	+\$425
42	42" wide <input type="checkbox"/> A	+\$455
48	48" wide <input type="checkbox"/> A	+\$475
54	54" wide <input type="checkbox"/> A	+\$550
60	60" wide <input type="checkbox"/> A	+\$600
66	66" wide <input type="checkbox"/> A	+\$675
72	72" wide <input type="checkbox"/> A	+\$810
Step 5. Case/Door Material		
<i>For 24" wide (24), 30" wide (30), or 36" wide (36)</i>		
L	laminated case and doors <input type="checkbox"/> A	+\$250
C	laminated case/veneer doors <input type="checkbox"/> A	+\$500
W	veneer case and doors <input type="checkbox"/> A	+\$1250

<i>For 42" wide (42), 48" wide (48), or 54" wide (54)</i>		
L	laminated case and doors <input type="checkbox"/> A	+\$400
C	laminated case/veneer doors <input type="checkbox"/> A	+\$600
W	veneer case and doors <input type="checkbox"/> A	+\$1400
<i>For 60" wide (60) or 66" wide (66)</i>		
L	laminated case and doors <input type="checkbox"/> A	+\$625
C	laminated case/veneer doors <input type="checkbox"/> A	+\$700
W	veneer case and doors <input type="checkbox"/> A	+\$2250
<i>For 72" wide (72)</i>		
L	laminated case and doors <input type="checkbox"/> A	+\$650
C	laminated case/veneer doors <input type="checkbox"/> A	+\$800
W	veneer case and doors <input type="checkbox"/> A	+\$2300
Step 6. Secondary Door Material		
A	translucent plastic <input type="checkbox"/> A	+\$280
P	painted <input type="checkbox"/> A	+\$180
Step 7. Lock		
L	lock <input type="checkbox"/> A	+\$0
N	no lock <input type="checkbox"/> A	+\$0
Step 8. Lock Option		
<i>For lock (L)</i>		
KA	keyed alike <input type="checkbox"/> A	-\$10
KC	keyed differently, chrome <input type="checkbox"/> A	+\$0
KD	keyed differently, black <input type="checkbox"/> A	+\$0

Overhead Storage Cabinet, Sliding Full Enclosure *continued*

Step 9. Case/Edge Finish

For laminate case and doors (L) or laminate case/veneer doors (C)

76	light brown walnut <input type="checkbox"/>	+\$0
8Q	folkstone grey <input type="checkbox"/>	+\$0
91	white <input type="checkbox"/>	+\$0
98	studio white <input type="checkbox"/>	+\$0
CL	cool grey neutral <input type="checkbox"/>	+\$0
HM	natural maple <input type="checkbox"/>	+\$0
HP	light anigre <input type="checkbox"/>	+\$0
HX	aged cherry <input type="checkbox"/>	+\$0
HY	walnut on cherry <input type="checkbox"/>	+\$0
LA	light ash <input type="checkbox"/>	+\$0
LBA	clear on ash <input type="checkbox"/>	+\$0
LBR	phantom ecru <input type="checkbox"/>	+\$0
LBS	phantom cocoa <input type="checkbox"/>	+\$0
LBU	medium matte walnut <input type="checkbox"/>	+\$0
LBV	warm grey teak <input type="checkbox"/>	+\$0
LBB	oak on ash <input type="checkbox"/>	+\$0
LBC	walnut on ash <input type="checkbox"/>	+\$0
LBD	dark brown walnut <input type="checkbox"/>	+\$0
LBE	medium red walnut <input type="checkbox"/>	+\$0
LBF	neutral twill <input type="checkbox"/>	+\$0
LBG	sarum twill <input type="checkbox"/>	+\$0
LBH	earthen twill <input type="checkbox"/>	+\$0
LBJ	graphite twill <input type="checkbox"/>	+\$0
LBK	pewter mesh <input type="checkbox"/>	+\$0
LBL	steel mesh <input type="checkbox"/>	+\$0
LBM	crisp linen <input type="checkbox"/>	+\$0
LBN	classic linen <input type="checkbox"/>	+\$0
LBP	casual linen <input type="checkbox"/>	+\$0
LBQ	white twill <input type="checkbox"/>	+\$0
LU	soft white <input type="checkbox"/>	+\$0
WL	sandstone <input type="checkbox"/>	+\$0
WN	warm grey neutral <input type="checkbox"/>	+\$0

Wood Veneer Case/Edge

For veneer case and doors (W)

2U	light brown walnut <input type="checkbox"/>	+\$0
40	dark brown walnut <input type="checkbox"/>	+\$0
ED	aged cherry <input type="checkbox"/>	+\$0
EK	medium red walnut <input type="checkbox"/>	+\$0
EW	medium matte walnut <input type="checkbox"/>	+\$0
ET	clear on ash <input type="checkbox"/>	+\$0
EU	oak on ash <input type="checkbox"/>	+\$0
EV	walnut on ash <input type="checkbox"/>	+\$0
UL	natural maple <input type="checkbox"/>	+\$0
UX	walnut on cherry <input type="checkbox"/>	+\$0

Overhead Storage Cabinet, Sliding Full Enclosure *continued*

Step 10. Primary Door/Edge finish

For laminate case and doors (L)

76	light brown walnut <input type="checkbox"/>	+\$0
8Q	folkstone grey <input type="checkbox"/>	+\$0
91	white <input type="checkbox"/>	+\$0
98	studio white <input type="checkbox"/>	+\$0
CL	cool grey neutral <input type="checkbox"/>	+\$0
HM	natural maple <input type="checkbox"/>	+\$0
HP	light anigre <input type="checkbox"/>	+\$0
HX	aged cherry <input type="checkbox"/>	+\$0
HY	walnut on cherry <input type="checkbox"/>	+\$0
LA	light ash <input type="checkbox"/>	+\$0
LBA	clear on ash <input type="checkbox"/>	+\$0
LBR	phantom ecru <input type="checkbox"/>	+\$0
LBS	phantom cocoa <input type="checkbox"/>	+\$0
LBU	medium matte walnut <input type="checkbox"/>	+\$0
LBV	warm grey teak <input type="checkbox"/>	+\$0
LBB	oak on ash <input type="checkbox"/>	+\$0
LBC	walnut on ash <input type="checkbox"/>	+\$0
LBD	dark brown walnut <input type="checkbox"/>	+\$0
LBE	medium red walnut <input type="checkbox"/>	+\$0
LBF	neutral twill <input type="checkbox"/>	+\$0
LBG	sarum twill <input type="checkbox"/>	+\$0
LBH	earthen twill <input type="checkbox"/>	+\$0
LBJ	graphite twill <input type="checkbox"/>	+\$0
LBK	pewter mesh <input type="checkbox"/>	+\$0
LBL	steel mesh <input type="checkbox"/>	+\$0
LBM	crisp linen <input type="checkbox"/>	+\$0
LBN	classic linen <input type="checkbox"/>	+\$0
LBP	casual linen <input type="checkbox"/>	+\$0
LBQ	white twill <input type="checkbox"/>	+\$0
LU	soft white <input type="checkbox"/>	+\$0
WL	sandstone <input type="checkbox"/>	+\$0
WN	warm grey neutral <input type="checkbox"/>	+\$0

For laminate case/veneer doors (C) or veneer case and doors (W)

2U	light brown walnut <input type="checkbox"/>	+\$0
40	dark brown walnut <input type="checkbox"/>	+\$0
ED	aged cherry <input type="checkbox"/>	+\$0
EK	medium red walnut <input type="checkbox"/>	+\$0
EW	medium matte walnut <input type="checkbox"/>	+\$0
ET	clear on ash <input type="checkbox"/>	+\$0
EU	oak on ash <input type="checkbox"/>	+\$0
EV	walnut on ash <input type="checkbox"/>	+\$0
UL	natural maple <input type="checkbox"/>	+\$0
UX	walnut on cherry <input type="checkbox"/>	+\$0

Step 11. Secondary Door Finish

Translucent Plastic

For translucent plastic (A)

J9	opal frosted <input type="checkbox"/>	+\$0
-----------	---------------------------------------	------

Bright Sand Texture Paint

For painted (P)

91	white <input type="checkbox"/>	+\$0
BU	black umber <input type="checkbox"/>	+\$0
CL	cool grey neutral <input type="checkbox"/>	+\$0
G1	graphite <input type="checkbox"/>	+\$0
LU	soft white <input type="checkbox"/>	+\$0
WN	warm grey neutral <input type="checkbox"/>	+\$0

Sand Texture Paint

For painted (P)

8Q	folkstone grey <input type="checkbox"/>	+\$0
98	studio white <input type="checkbox"/>	+\$0
WL	sandstone <input type="checkbox"/>	+\$0

Metallic Paint

For painted (P)

CN	metallic champagne <input type="checkbox"/>	+\$0
EH	metallic bronze <input type="checkbox"/>	+\$0
MS	metallic silver <input type="checkbox"/>	+\$0

Overhead Storage Cabinet, Sliding Doors

FV43S.

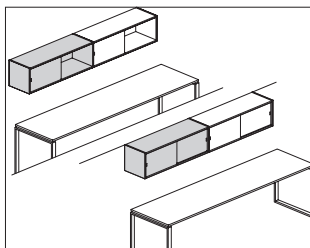

Product Information

Description

This cabinet mounts to a Canvas wall-based frame or attaches to an architectural wall and provides partial or fully enclosed storage. The back-painted glass doors slide along an inset track. Doors are nonlockable and include a notched pull. Doors can slide the entire width of the cabinet. Cabinet accepts a task light.

Notes

Partial sliding (1P) units have 1 door; full sliding (2F) units have 2 doors. Cabinets up to 48" wide have no center divider; 54"-72" wide units have 1 center divider.

Canvas frame connection (F8) option includes attachment hardware. For wall mount (WM) option, attachment hardware must be customer supplied.

Cabinet with finished case top (WT) aligns with top of the bead on a frame-attached tile. Adding a thin top increases overall cabinet height 1/2".

Align like components next to like units: Finished case units with other finished case units, thin top units with other thin top units.

Grain direction is vertical on veneer and wood-grain laminate doors.

Grain direction is horizontal on laminate door units wider than 60".

Order optional task lights and accessories separately:

- Cable management clips (FT198.), when cabinet is frame attached
- Cord manager (FV984.), when cabinet is wall attached
- Performance task light (G6114.xxxxT)
- Utility task light (G6136.xxT)
- Twist™ LED task light (G6160.xB)
- Cast LED light(FV617.)

Glass doors are back-painted and writable with dry erase marker. Doors are nonmagnetic. Glass doors cannot lock.

For additional product options, see Vary Easy Program in appendices.

Dimensions

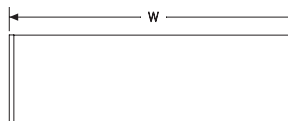

1 Partial Sliding Door

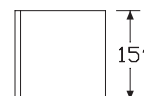

2 Full Sliding Door

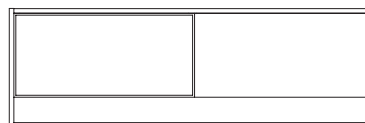

1 Partial Sliding Door

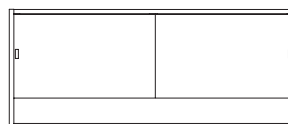
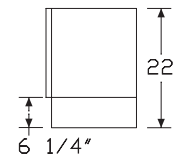

2 Full Sliding Door

Overhead Storage Cabinet, Sliding Doors *continued*

Specification Information

Step 1.

FV43S. A

Step 2. Attachment Bracket

F8 Canvas frame connection A +\$100
WM wall mount A +\$200

Step 3. Height

15 15" high A +\$300
22 22" high with cubby A +\$500

Step 4. Width

For Canvas frame connection (F8)

24 24" wide A +\$325
30 30" wide A +\$355
36 36" wide A +\$425
42 42" wide A +\$455
48 48" wide A +\$475

For wall mount (WM)

24 24" wide A +\$325
30 30" wide A +\$355
36 36" wide A +\$425
42 42" wide A +\$455
48 48" wide A +\$475
54 54" wide A +\$550
60 60" wide A +\$600
66 66" wide A +\$675
72 72" wide A +\$810

Step 5. Configuration

1P 1 partial sliding door A +\$0
2F 2 full sliding doors A +\$700

Step 6. Case/Door Material

For 24" wide (24), 30" wide (30), or 36" wide (36)

G laminate case/glass doors A +\$525
R veneer case/glass doors A +\$1350

For 42" wide (42), 48" wide (48), or 54" wide (54)

G laminate case/glass doors A +\$775
R veneer case/glass doors A +\$1600

For 60" wide (60) or 66" wide (66)

G laminate case/glass doors A +\$1100
R veneer case/glass doors A +\$2550

For 72" wide (72)

G laminate case/glass doors A +\$1225
R veneer case/glass doors A +\$2700

Step 7. Top

WT finished case top A +\$0
03 3/8" laminate thin top A +\$150
04 3/8" veneer thin top A +\$300
NT no top for use with 3/8" common thin top A +\$50

Overhead Storage Cabinet, Sliding Doors *continued*

Step 8. Case/Edge Finish

For laminate case/glass doors (G)

76	light brown walnut <input type="checkbox"/>	+\$0
8Q	folkstone grey <input type="checkbox"/>	+\$0
91	white <input type="checkbox"/>	+\$0
98	studio white <input type="checkbox"/>	+\$0
CL	cool grey neutral <input type="checkbox"/>	+\$0
HM	natural maple <input type="checkbox"/>	+\$0
HP	light anigre <input type="checkbox"/>	+\$0
HX	aged cherry <input type="checkbox"/>	+\$0
HY	walnut on cherry <input type="checkbox"/>	+\$0
LA	light ash <input type="checkbox"/>	+\$0
LBA	clear on ash <input type="checkbox"/>	+\$0
LBR	phantom ecru <input type="checkbox"/>	+\$0
LBS	phantom cocoa <input type="checkbox"/>	+\$0
LBU	medium matte walnut <input type="checkbox"/>	+\$0
LBV	warm grey teak <input type="checkbox"/>	+\$0
LBB	oak on ash <input type="checkbox"/>	+\$0
LBC	walnut on ash <input type="checkbox"/>	+\$0
LBD	dark brown walnut <input type="checkbox"/>	+\$0
LBE	medium red walnut <input type="checkbox"/>	+\$0
LBF	neutral twill <input type="checkbox"/>	+\$0
LBG	sarum twill <input type="checkbox"/>	+\$0
LBH	earthen twill <input type="checkbox"/>	+\$0
LBJ	graphite twill <input type="checkbox"/>	+\$0
LBK	pewter mesh <input type="checkbox"/>	+\$0
LBL	steel mesh <input type="checkbox"/>	+\$0
LBM	crisp linen <input type="checkbox"/>	+\$0
LBN	classic linen <input type="checkbox"/>	+\$0
LBP	casual linen <input type="checkbox"/>	+\$0
LBQ	white twill <input type="checkbox"/>	+\$0
LU	soft white <input type="checkbox"/>	+\$0
WL	sandstone <input type="checkbox"/>	+\$0
WN	warm grey neutral <input type="checkbox"/>	+\$0

For veneer case/glass doors (R)

2U	light brown walnut <input type="checkbox"/>	+\$0
40	dark brown walnut <input type="checkbox"/>	+\$0
ED	aged cherry <input type="checkbox"/>	+\$0
EK	medium red walnut <input type="checkbox"/>	+\$0
EW	medium matte walnut <input type="checkbox"/>	+\$0
ET	clear on ash <input type="checkbox"/>	+\$0
EU	oak on ash <input type="checkbox"/>	+\$0
EV	walnut on ash <input type="checkbox"/>	+\$0
UL	natural maple <input type="checkbox"/>	+\$0
UX	walnut on cherry <input type="checkbox"/>	+\$0

Step 9. Door/Edge Finish

91	white <input type="checkbox"/>	+\$0
98	studio white <input type="checkbox"/>	+\$0
8Q	folkstone grey <input type="checkbox"/>	+\$0

Step 10. Top/Edge Finish

For 3/8" laminate thin top (O3)

76	light brown walnut <input type="checkbox"/>	+\$0
8Q	folkstone grey <input type="checkbox"/>	+\$0
91	white <input type="checkbox"/>	+\$0
98	studio white <input type="checkbox"/>	+\$0
CL	cool grey neutral <input type="checkbox"/>	+\$0
HM	natural maple <input type="checkbox"/>	+\$0
HP	light anigre <input type="checkbox"/>	+\$0
HX	aged cherry <input type="checkbox"/>	+\$0
HY	walnut on cherry <input type="checkbox"/>	+\$0
LA	light ash <input type="checkbox"/>	+\$0
LBA	clear on ash <input type="checkbox"/>	+\$0
LBR	phantom ecru <input type="checkbox"/>	+\$0
LBS	phantom cocoa <input type="checkbox"/>	+\$0
LBU	medium matte walnut <input type="checkbox"/>	+\$0
LBV	warm grey teak <input type="checkbox"/>	+\$0
LBB	oak on ash <input type="checkbox"/>	+\$0
LBC	walnut on ash <input type="checkbox"/>	+\$0
LBD	dark brown walnut <input type="checkbox"/>	+\$0
LBE	medium red walnut <input type="checkbox"/>	+\$0
LBF	neutral twill <input type="checkbox"/>	+\$0
LBG	sarum twill <input type="checkbox"/>	+\$0
LBH	earthen twill <input type="checkbox"/>	+\$0
LBJ	graphite twill <input type="checkbox"/>	+\$0
LBK	pewter mesh <input type="checkbox"/>	+\$0
LBL	steel mesh <input type="checkbox"/>	+\$0
LBM	crisp linen <input type="checkbox"/>	+\$0
LBN	classic linen <input type="checkbox"/>	+\$0
LBP	casual linen <input type="checkbox"/>	+\$0
LBQ	white twill <input type="checkbox"/>	+\$0
LU	soft white <input type="checkbox"/>	+\$0
WL	sandstone <input type="checkbox"/>	+\$0
WN	warm grey neutral <input type="checkbox"/>	+\$0

Overhead Storage Cabinet, Sliding Doors *continued*

Canvas Office Landscape® Storage

For 3/8" veneer thin top (04)

2U	light brown walnut <input type="checkbox"/>	+\$85
40	dark brown walnut <input type="checkbox"/>	+\$85
ED	aged cherry <input type="checkbox"/>	+\$85
EK	medium red walnut <input type="checkbox"/>	+\$85
EW	medium matte walnut <input type="checkbox"/>	+\$85
ET	clear on ash <input type="checkbox"/>	+\$85
EU	oak on ash <input type="checkbox"/>	+\$85
EV	walnut on ash <input type="checkbox"/>	+\$85
UL	natural maple <input type="checkbox"/>	+\$85
UX	walnut on cherry <input type="checkbox"/>	+\$85

B-Style Flipper Door Unit

FT420.

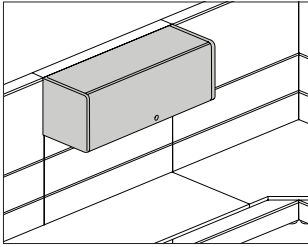

Product Information

Description

This 13"-deep lockable storage unit hangs on- or off-module from a frame, wall strips, or off-module upper tile. It combines a flipper door and shelf to enclose binders, files, and other items. The flipper door unit has a painted or fabric-covered door. The underside of the shelf accepts a task light. Attachment hardware included. Shipped knocked down.

A 60"-wide unit hangs on frames with a combined width of 60".

When hung off-module, the flipper door unit attaches in 1" intervals and can span more than 1 off-module upper tile.

Metallic silver (MS) case has cool grey neutral (CL) end panels. Metallic champagne (CN) and metallic bronze (EH) cases have warm grey neutral (WN) end panels.

Notes

When hung off-module, the flipper door unit's placement is determined by the location of off-module upper tile(s).

Order optional task light separately:

- Energy-efficient task light (G6120.)
- Performance task light (G6114.)
- Utility task light (G6136.)
- Twist™ LED task light (G6160.)

For 60"-wide flipper door unit, order 60"-wide task light.

Order optional angled shelf divider (G7330.) separately.

To enclose back of unit, order A-/B-style flipper door back panel (A3390.) separately. For off-module applications, a back panel is recommended.

Fabric-covered flipper door accepts Customer's Own Material (COM).

Yardage is estimated for nondirectional, 54"-wide fabrics.

Width—Yardage

24" to 48" —²/₃

60" — 2

60" —²/₃, for 66"-wide fabrics

For information on multiple quantities or directional fabrics, contact COM Department. See Order Information in Appendices.

For keyed-alike locks, order lock plugs separately. See Keyed-Alike Information in Appendices.

Dimensions

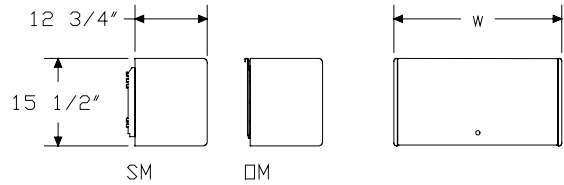

B-Style Flipper Door Unit *continued*

Specification Information

Step 1.

FT420.

Step 2. Width

24	24" wide
30	30" wide
36	36" wide
42	42" wide
48	48" wide
60	60" wide

Step 3. Door Material

P	Painted door
F	Fabric door

Step 4. Lock

N	no lock
L	lock

Prices for Steps 1-4.

	N	L
FT420. 24 P	\$412	426
F	\$427	439
30 P	\$436	449
F	\$449	464
36 P	\$473	485
F	\$485	498
42 P	\$508	521
F	\$522	535
48 P	\$538	551
F	\$551	565
60 P	\$660	673
F	\$673	686

Step 5. Lock Option

For lock (L)

KA	keyed alike	-\$10
KD	keyed differently	+\$0

Step 6. Case Finish

Bright Sand Texture Paint

91	white	+\$0
CL	cool grey neutral	+\$0
G1	graphite	+\$0
WN	warm grey neutral	+\$0
8Q	folkstone grey	+\$0
98	studio white	+\$0
WL	sandstone	+\$0

Metallic Paint

CN	metallic champagne	+\$0
EH	metallic bronze	+\$0
MS	metallic silver	+\$0

Step 7. Door Finish

For painted door (P)

Bright Sand Texture Paint

91	white	+\$0
CL	cool grey neutral	+\$0
G1	graphite	+\$0
WN	warm grey neutral	+\$0
8Q	folkstone grey	+\$0
98	studio white	+\$0
WL	sandstone	+\$0

Metallic Paint

CN	metallic champagne	+\$0
EH	metallic bronze	+\$0
MS	metallic silver	+\$0

Step 8. End Panel Option

OM	off module	+\$0
SM	on module	+\$0

B-Style Flipper Door Unit *continued*

Step 9. Door Finish

See application chart and textiles list for fabric usage and numbers.

First 2 digits of number indicate fabric line; remaining digit(s) indicate fabric color.

For 24" wide (24), 30" wide (30), 36" wide (36), 42" wide (42), or 48" wide (48) with fabric door (F)

Price Category 1	+\$0
Price Category 2	+\$18
Price Category 3	+\$37
Price Category 4	+\$54
Price Category 5	+\$87
Price Category B	+\$35
Price Category C	+\$51
Price Category D	+\$64
Price Category E	+\$78
Price Category F	+\$100
Price Category G	+\$130

For 60" wide (60) with fabric door (F)

Price Category 1	+\$0
Price Category 2	+\$18
Price Category 3	+\$37
Price Category 4	+\$54
Price Category B	+\$35
Price Category C	+\$51
Price Category D	+\$64

B-Style Shelf

FT422.

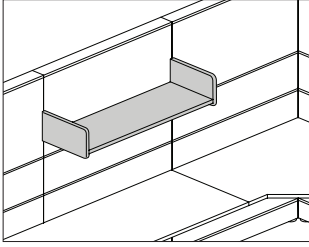

Product Information

Description

This shelf hangs on- or off-module from a frame, wall strips, or off-module upper tile. The underside of the shelf accepts a task light.

Attachment hardware is included. Shipped knocked down.

The shelf is available in 2 heights: the 7 1/2"-high shelf is for storage or display and the 15 1/2"-high shelf stores binders and books. A 60"-wide shelf hangs on frames with a combined width of 60".

When hung off-module, the shelf attaches in 1" intervals and can span more than 1 off-module upper tile.

Metallic silver (MS) case has cool grey neutral (CL) end panels. Metallic champagne (CN) and metallic bronze (EH) cases have warm grey neutral (WN) end panels.

Notes

To hang shelf from an off-module upper tile, specify 15 1/2"-high shelf (FT422.15.).

When hung off-module, shelf placement is determined by the location of off-module upper tile(s).

Order optional task light separately:

- Energy-efficient task light (G6120.)
- Performance task light (G6114.)
- Utility task light (G6136.)
- Twist™ LED task light (G6160.)

For 60"-wide shelf, order 60"-wide task light.

Order optional angled shelf divider (G7330.) separately.

For enclosed storage on 15 1/2"-high shelf, order B-style flipper door (FT421.) separately.

Dimensions

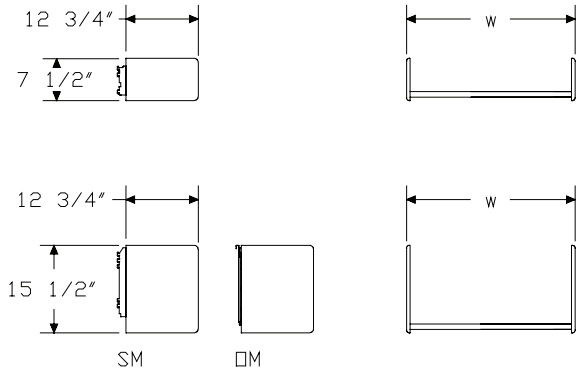

B-Style Shelf *continued*

Specification Information

Step 1.

FT422.

Step 2. Height

- 07** 7½" high
15 15½" high

Step 3. Width

- 24** 24" wide
30 30" wide
36 36" wide
42 42" wide
48 48" wide
60 60" wide

Prices for Steps 1-3.

	24	30	36	42	48	60
FT422. 07	\$130	137	146	157	162	200
15	\$175	181	191	201	207	242

Step 4. Surface Finish

Bright Sand Texture Paint

91	white	+\$0
CL	cool grey neutral	+\$0
G1	graphite	+\$0
WN	warm grey neutral	+\$0
8Q	folkstone grey	+\$0
98	studio white	+\$0
WL	sandstone	+\$0

Metallic Paint

CN	metallic champagne	+\$0
EH	metallic bronze	+\$0
MS	metallic silver	+\$0

Step 5. End Panel Option

For 15½" high (15)

OM	off module	+\$0
SM	on module	+\$0

E-Style Flipper Door Unit

FT430.

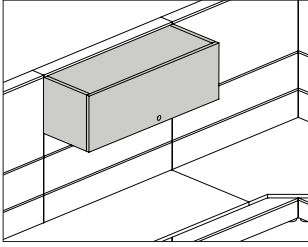

Canvas Office Landscape® Storage

Product Information

Description

This 13½"-deep lockable storage unit hangs on- or off-module from a frame, wall strips, or off-module upper tile. It combines a flipper door and shelf to enclose binders, files, and other items. The flipper door unit has a fabric-covered or veneer door. The underside of the shelf accepts a task light. Attachment hardware is included. Shipped knocked down.

When hung off-module, the storage unit attaches in 1" intervals and can span more than 1 off-module upper tile.

Metallic silver (MS) case has cool grey neutral (CL) end panels. Metallic champagne (CN) and metallic bronze (EH) cases have warm grey neutral (WN) end panels.

Notes

When hung off-module, storage unit placement is determined by the location of off-module upper tile(s).

Order optional task light separately:

- Energy-efficient task light (G6120.)
- Performance task light (G6114.)
- Utility task light (G6136.)
- Twist™ LED task light (G6160.)

Order optional angled shelf divider (G7330.) separately.

To enclose back of unit, order E-style flipper door back panel (E3190.) separately.

Fabric-covered flipper door accepts Customer's Own Material (COM).

For nondirectional fabrics, order minimum of ⅔ yard. For information on multiple quantities or directional fabrics, contact COM Department. See

Order Information in Appendices.

For keyed-alike locks, order lock plugs separately. See Keyed-Alike Information in Appendices.

Dimensions

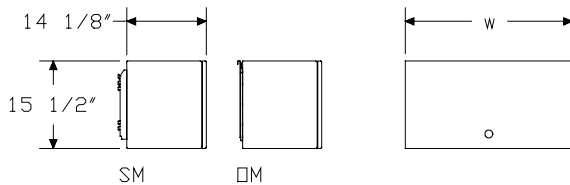

Specification Information

Step 1.

FT430.

Step 2. Width

24	24" wide
30	30" wide
36	36" wide
42	42" wide
48	48" wide

Step 3. Door Material

F	fabric door
W	veneer door with horizontal grain <input type="checkbox"/> A

Prices for Steps 1-3.

		F	W
FT430. 24		\$504	728
30		\$543	776
36		\$585	826
42		\$622	873
48		\$661	918

Step 4. Lock Option

KA	keyed alike	-\$10
KD	keyed differently	+\$0

Step 5. Case Finish

Bright Sand Texture Paint

91	white	+\$0
CL	cool grey neutral	+\$0
G1	graphite	+\$0
WN	warm grey neutral	+\$0
8Q	folkstone grey	+\$0
98	studio white	+\$0
WL	sandstone	+\$0

Metallic Paint

CN	metallic champagne	+\$0
EH	metallic bronze	+\$0
MS	metallic silver	+\$0

E-Style Flipper Door Unit *continued*

Step 6. Door Finish

For veneer door with horizontal grain (W)

Wood Veneer

2U	light brown walnut <input type="checkbox"/> A	+\$105
40	dark brown walnut	+\$105
ED	aged cherry <input type="checkbox"/> A	+\$105
EK	medium red walnut	+\$105
EW	medium matte walnut	+\$105
ET	clear on ash <input type="checkbox"/> A	+\$105
EU	oak on ash <input type="checkbox"/> A	+\$105
EV	walnut on ash <input type="checkbox"/> A	+\$105
UL	natural maple <input type="checkbox"/> A	+\$105
UX	walnut on cherry <input type="checkbox"/> A	+\$105

Step 7. End Panel Option

OM	off module	+\$0
SM	on module	+\$0

Step 8. Door Finish

For fabric door (F)

See application chart and textiles list for fabric usage and numbers.

First 2 digits of number indicate fabric line; remaining digit(s) indicate fabric color.

Price Category 1	+\$0
Price Category 2	+\$18
Price Category 3	+\$37
Price Category 4	+\$54
Price Category 5	+\$87
Price Category B	+\$35
Price Category C	+\$51
Price Category D	+\$64
Price Category E	+\$78
Price Category F	+\$100

E-Style Shelf

FT432.

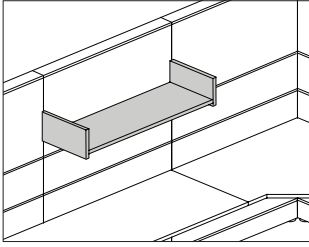

Canvas Office Landscape® Storage

Product Information

Description

This shelf hangs on- or off-module from a frame, wall strips, or an off-module upper tile. It is available in 2 heights: the 7½"-high shelf is for storage or display and the 15½"-high shelf stores binders and books. The underside of the shelf accepts a task light. Attachment hardware is included. Shipped knocked down.

When hung off-module, the shelf attaches in 1" intervals and can span more than 1 off-module upper tile.

Metallic silver (MS) case has cool grey neutral (CL) end panels. Metallic champagne (CN) and metallic bronze (EH) cases have warm grey neutral (WN) end panels.

Notes

To hang shelf from an off-module upper tile, specify 15½"-high shelf (FT432.15.).

When hung off-module, shelf placement is determined by the location of off-module upper tile(s).

Order optional task light separately:

- Energy-efficient task light (G6120.)
- Performance task light (G6114.)
- Utility task light (G6136.)
- Twist™ LED task light (G6160.)

Order optional angled shelf divider (G7330.) separately.

For enclosed storage on 15½"-high shelf, order E-style flipper door (FT431.) separately.

Dimensions

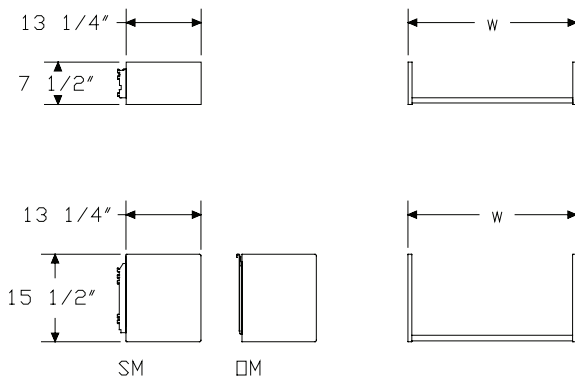

Specification Information

Step 1.

FT432.

Step 2. Height

- 07** 7½" high
- 15** 15½" high

Step 3. Width

- 24** 24" wide
- 30** 30" wide
- 36** 36" wide
- 42** 42" wide
- 48** 48" wide

Prices for Steps 1-3.

	24	30	36	42	48
FT432. 07	\$212	228	243	255	266
15	\$247	268	286	306	323

Step 4. Surface Finish

Bright Sand Texture Paint

91	white	+\$0
CL	cool grey neutral	+\$0
G1	graphite	+\$0
WN	warm grey neutral	+\$0
8Q	folkstone grey	+\$0
98	studio white	+\$0
WL	sandstone	+\$0

Metallic Paint

CN	metallic champagne	+\$0
EH	metallic bronze	+\$0
MS	metallic silver	+\$0

Step 5. End Panel Option

For 15½" high (15)

OM	off module	+\$0
SM	on module	+\$0

Floating Shelf, Aluminum

FV434.

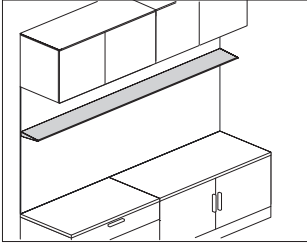

Product Information

Description

This painted aluminum floating shelf has a thin profile that is $\frac{1}{4}$ " thick at the front increasing to 1" thick at the back. The shelf is $8\frac{3}{4}$ " deep and provides an area for display. Shelf mounts directly to an architectural wall, and has an option for an LED accent light.

Notes

- Shelf is not intended for book and binder storage.
- Shelf is wall mounted (WM) only; attachment hardware must be customer supplied.
- Width of LED light aligns with shelf width. Light is factory installed and includes a translucent plastic light cover. Cord length is 11'.

Dimensions

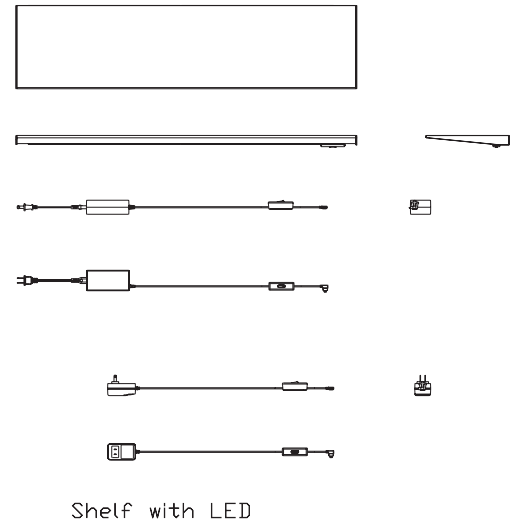
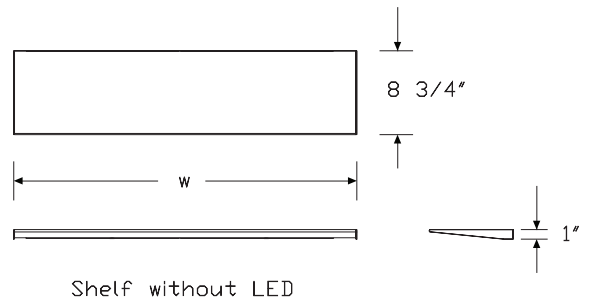

Canvas Office Landscape® Storage

Floating Shelf, Aluminum *continued*

Specification Information

Step 1.

FV434. A

Step 2. Attachment Bracket

WM wall mount A

Step 3. Shelf Type

N shelf without light A

L shelf with light A

Step 4. Material

A painted aluminum A

Step 5. Width

24 24" wide A

30 30" wide A

36 36" wide A

42 42" wide A

48 48" wide A

54 54" wide A

60 60" wide A

66 66" wide A

72 72" wide A

78 78" wide A

84 84" wide A

90 90" wide A

96 96" wide A

Prices for Steps 1-5.

	A24	A30	A36	A42	A48	A54
FV434. WM N	\$1075	1150	1225	1300	1375	1450
L	\$1150	1250	1350	1450	1550	1650

	A60	A66	A72	A78	A84	A90
FV434. WM N	\$1525	1600	1675	1710	1750	1825
L	\$1750	1850	1950	1985	2025	2100

	A96
FV434. WM N	\$1900
L	\$2175

Step 6. Shelf Finish

8Q folkstone grey A +\$0

91 white A +\$0

98 studio white A +\$0

CL cool grey neutral A +\$0

CN metallic champagne A +\$0

EH metallic bronze A +\$0

G1 graphite A +\$0

MS metallic silver A +\$0

WL sandstone A +\$0

WN warm grey neutral A +\$0

Glass Back Panel

FV970.

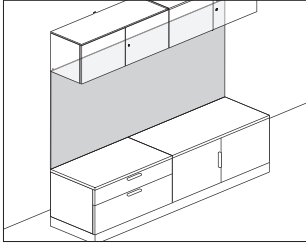

Product Information

Description

This back-painted glass back panel mounts to a wall above a work surface or above a low credenza with 2 1/4" base. Surface is writable. Attachment hardware included.

Notes

For exact dimensions, see Canvas Office Landscape® Planning Guide for Wall-Based and Private Office.

Dimensions

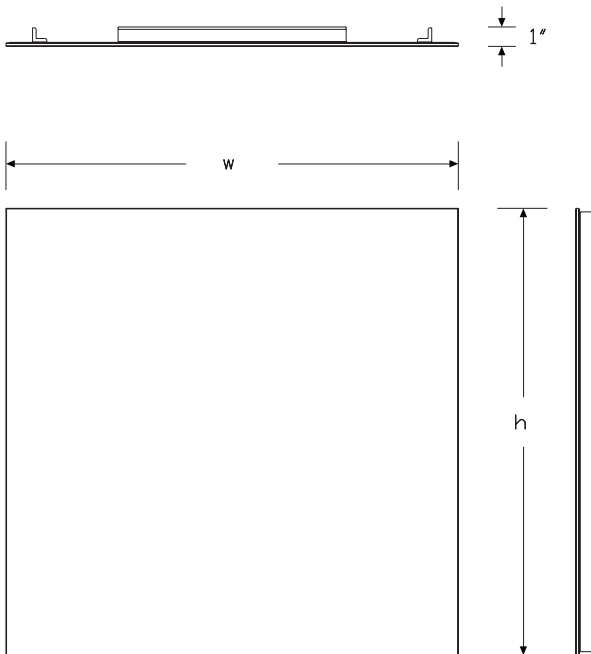

Specification Information

Step 1.

FV970.

Step 2. Mount Option

WM wall mount

Step 3. Surface Material

G glass

Step 4. Height

- 23A** 23 1/2" high to go between a work surface (28.5" high) and a 15" high overhead at a 68" high datum
- 30A** 30 7/8" high to go between a low credenza (1 1/4" thick top and 2 1/4" base) and a 15" high overhead at a 68" high datum
- 31A** 31 1/2" high to go between a low credenza (3/8" thin top and 2 1/4" base) and a 15" high overhead at a 68" high datum
- 38A** 38 1/2" high to go above a work surface (28.5" high) without an overhead at a 68" high datum
- 45A** 45 7/8" high to go above a low credenza (1 1/4" thick top and 2 1/4" base) without an overhead at a 68" high datum
- 46A** 46 1/2" high to go above a low credenza (3/8" thin top and 2 1/4" base) without an overhead at a 68" high datum

Step 5. Width

For 23 1/2" high to go between a work surface (28.5" high) and a 15" high overhead at a 68" high datum (23A), 30 7/8" high to go between a low credenza (1 1/4" thick top and 2 1/4" base) and a 15" high overhead at a 68" high datum (30A), or 31 1/2" high to go between a low credenza (3/8" thin top and 2 1/4" base) and a 15" high overhead at a 68" high datum (31A)

- 24** 24" wide
- 30** 30" wide
- 36** 36" wide
- 42** 42" wide
- 48** 48" wide
- 54** 54" wide
- 60** 60" wide
- 66** 66" wide
- 72** 72" wide
- 78** 78" wide
- 84** 84" wide
- 90** 90" wide
- 96** 96" wide

Glass Back Panel *continued*

Canvas Office Landscape® Storage

For 38½" high to go above a work surface (28.5" high) without an overhead at a 68" high datum (38A), 45⅞" high to go above a low credenza (1¼" thick top and 2¼" base) without an overhead at a 68" high datum (45A), or 46½" high to go above a low credenza (¾" thin top and 2¼" base) without an overhead at a 68" high datum (46A)

24	24" wide
30	30" wide
36	36" wide
42	42" wide
48	48" wide
54	54" wide
60	60" wide
66	66" wide
72	72" wide

Step 6. Type

M	magnetic
----------	----------

Prices for Steps 1-6.

	23A24M	23A30M	23A36M	23A42M	23A48M	23A54M
FV970. WM G	\$825	1030	1235	1440	1645	1850
	23A60M	23A66M	23A72M	23A78M	23A84M	23A90M
FV970. WM G	\$2060	2265	2470	2675	2880	3085
	23A96M	30A24M	30A30M	30A36M	30A42M	30A48M
FV970. WM G	\$3290	1075	1340	1610	1880	2150
	30A54M	30A60M	30A66M	30A72M	30A78M	30A84M
FV970. WM G	\$2415	2685	2950	3220	3490	3755
	30A90M	30A96M	31A24M	31A30M	31A36M	31A42M
FV970. WM G	\$4025	4290	1110	1385	1665	1940
	31A48M	31A54M	31A60M	31A66M	31A72M	31A78M
FV970. WM G	\$2220	2495	2770	3050	3325	3605
	31A84M	31A90M	31A96M	38A24M	38A30M	38A36M
FV970. WM G	\$3880	4160	4435	1360	1700	2040
	38A42M	38A48M	38A54M	38A60M	38A66M	38A72M
FV970. WM G	\$2380	2720	3060	3400	3740	4080
	45A24M	45A30M	45A36M	45A42M	45A48M	45A54M
FV970. WM G	\$1610	2015	2415	2820	3220	3620

	45A60M	45A66M	45A72M	46A24M	46A30M	46A36M
FV970. WM G	\$4025	4425	4830	1645	2060	2470
	46A42M	46A48M	46A54M	46A60M	46A66M	46A72M
FV970. WM G	\$2880	3290	3700	4115	4525	4935

Step 7. Finish

8Q	folkstone grey					+\$0
91	white					+\$0
98	studio white					+\$0

Glass Back Panel, Used with Floating Shelf

FV972.

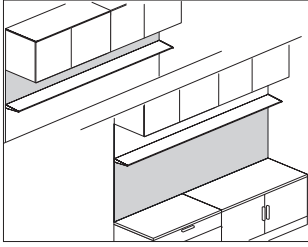

Product Information

Description

This back-painted glass back panel mounts to an architectural wall and is to be used with the floating aluminum shelf. Back panel surface is writable. Attachment hardware included.

Notes

Order floating shelf, aluminum (FV434.) separately.

Glass back panels are optimized to support a 68"-high Canvas datum.

Glass back panels feature a 5"W x 3/4"D vertical channel on each side for cable management.

See Canvas Office Landscape® Wall-Based and Private Office Planning Guide for exact dimensions.

Dimensions

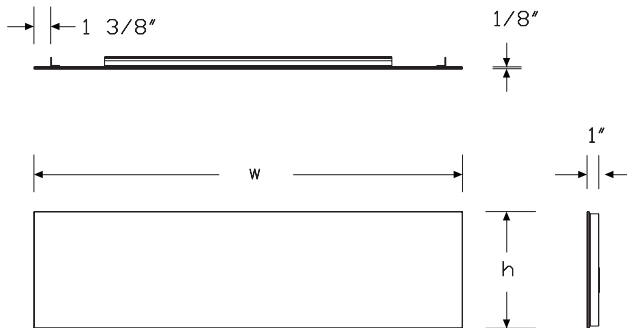

Specification Information

Step 1.

FV972.

Step 2. Mount Option

WM wall mount

Step 3. Surface Material

G glass

Step 4. Height

10A 9 3/4" H between floating shelf and 15" H overhead at 68" H datum

13A 12" H

14A 14" H

19A 19 7/8" H

20A 20 1/2" H above a low credenza (3/8" H top and 2 1/4" H base) below floating shelf with 10" H glass and 15" H overhead

Step 5. Width

24 24" wide

30 30" wide

36 36" wide

42 42" wide

48 48" wide

54 54" wide

60 60" wide

66 66" wide

72 72" wide

78 78" wide

84 84" wide

90 90" wide

96 96" wide

Step 6. Type

M magnetic

Prices for Steps 1-6.

	10A24M	10A30M	10A36M	10A42M	10A48M	10A54M
FV972. WM G	\$475	525	590	660	720	805
	10A60M	10A66M	10A72M	10A78M	10A84M	10A90M
FV972. WM G	\$894	984	1073	1163	1252	1341
	10A96M	13A24M	13A30M	13A36M	13A42M	13A48M
FV972. WM G	\$1431	575	655	775	850	975

Glass Back Panel, Used with Floating Shelf *continued*

Canvas Office Landscape® Storage

	13A54M	13A60M	13A66M	13A72M	13A78M	13A84M
FV972. WM G	\$1085	1210	1330	1450	1570	1670

	13A90M	13A96M	14A24M	14A30M	14A36M	14A42M
FV972. WM G	\$1810	1930	580	660	750	877

	14A48M	14A54M	14A60M	14A66M	14A72M	14A78M
FV972. WM G	\$1002	1126	1252	1377	1500	1630

	14A84M	14A90M	14A96M	19A24M	19A30M	19A36M
FV972. WM G	\$1755	1890	2000	750	890	1070

	19A42M	19A48M	19A54M	19A60M	19A66M	19A72M
FV972. WM G	\$1245	1421	1600	1775	1955	2135

	19A78M	19A84M	19A90M	19A96M	20A24M	20A30M
FV972. WM G	\$2310	2490	2665	2845	765	915

	20A36M	20A42M	20A48M	20A54M	20A60M	20A66M
FV972. WM G	\$1100	1285	1470	1650	1835	2015

	20A72M	20A78M	20A84M	20A90M	20A96M
FV972. WM G	\$2200	2382	2565	2750	2933

Step 7. Finish		
8Q	folkstone grey	+\$0
91	white	+\$0
98	studio white	+\$0

B-Style Flipper Door Back Panel A3390.

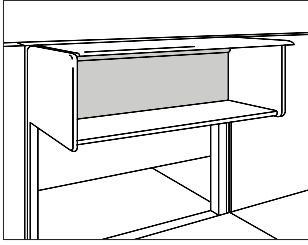

Product Information

Description

This panel attaches to the back of a B-style flipper door unit or a flipper door with shelf to enclose the back. Attachment hardware is included.

Dimensions

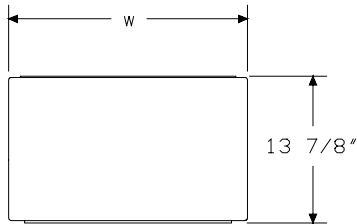

Specification Information

Step 1.

A3390.

Step 2. Width

- 24** 24" wide
- 30** 30" wide
- 36** 36" wide
- 42** 42" wide
- 48** 48" wide

Prices for Steps 1-2.

A3390. 24	\$91
30	\$91
36	\$99
42	\$103
48	\$105

Step 3. Surface Finish

8Q	folkstone grey	+\$0
91	white	+\$0
98	studio white A	+\$0
BU	black umber	+\$0
CL	cool grey neutral	+\$0
CN	metallic champagne	+\$0
EH	metallic bronze	+\$0
G1	graphite	+\$0
HF	inner tone light	+\$0
LT	light tone	+\$0
LU	soft white	+\$0
MS	metallic silver	+\$0
MT	medium tone	+\$0
SG	slate grey	+\$0
WL	sandstone	+\$0
WN	warm grey neutral	+\$0

Inline Glass Back Panel, Overhead FV971.

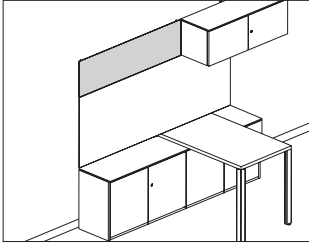

Canvas Office Landscape® Storage

Product Information

Description
This back-painted glass back panel mounts to a wall adjacent to a 15" overhead storage unit. Surface is writable. Attachment hardware included.

Notes
For exact dimensions, see Canvas Office Landscape® Planning Guide for Wall-Based and Private Office.

Dimensions

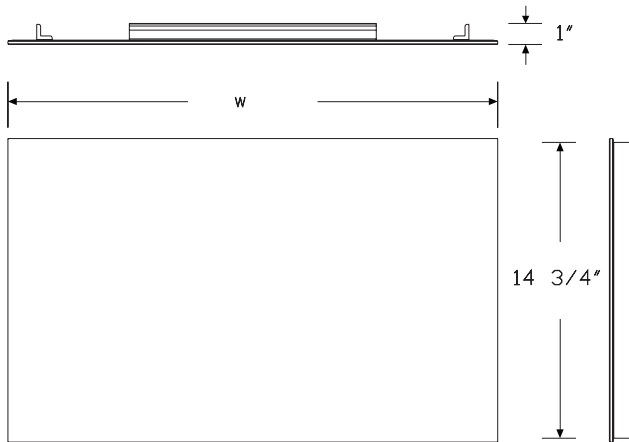

Specification Information

Step 1.
FV971.

Step 2. Mount Option
WM wall mount

Step 3. Surface Material
G glass

Step 4. Height
15 15" high overhead

Step 5. Width
24 24" wide
30 30" wide
36 36" wide
42 42" wide
48 48" wide
54 54" wide
60 60" wide
66 66" wide
72 72" wide

Step 6. Type
M magnetic

Prices for Steps 1-6.

	1524M	1530M	1536M	1542M	1548M	1554M
FV971. WM G	\$540	670	805	940	1075	1210
					1560M	1566M
FV971. WM G					\$1340	1475
						1572M
FV971. WM G						1610

Step 7. Finish
8Q folkstone grey +\$0
91 white +\$0
98 studio white +\$0

C-Style Flipper Door Unit

X3750.

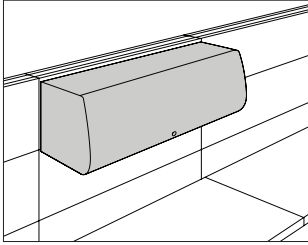

Product Information

Description

This curved-front storage unit hangs from the following products: Action Office® Series 1 or Series 2 panel or wall strips; Canvas Wall frame, off-module upper tile, or wall strips; or Ethospace® on- or off-module frame, off-module upper tile, or wall strips. It combines a flipper door and a 13³/₄"-deep shelf to enclose binders, files, and other items. The unit has a painted door that opens over the case and 2 door mechanisms: a standard mechanism or a lift-assisted mechanism. A lift handle can be specified to enable easier lifting and closing of the flipper door. The underside of the shelf accepts a task light. Attachment hardware is included. Shipped knocked down.

Storage units can hang from 2 panels or 2 frames with a combined width of 36", 42", or 48". The 36", 42", and 48"-wide units can also span more than 1 Canvas or Ethospace off-module upper tile.

Metallic silver (MS) case has cool grey neutral (CL) end panels and lift handle. Metallic champagne (CN) and metallic bronze (EH) cases have warm grey neutral (WN) end panels and lift handles.

Notes

Lift handle conforms to guidelines of Americans with Disabilities Act (ADA).

Canvas or Ethospace off-module upper tile location determines placement of storage unit.

Order optional task light separately:

- Energy-efficient task light (G6120.)
- Performance task light (G6114.)
- Utility task light (G6136.)
- Twist™ LED task light (G6160.)

Order optional angled shelf divider (G7330.) separately.

To enclose back of unit, order C-style flipper door back panel (X3790.) separately.

For keyed-alike locks, order lock plugs separately. See Keyed-Alike Information in Appendices.

Dimensions

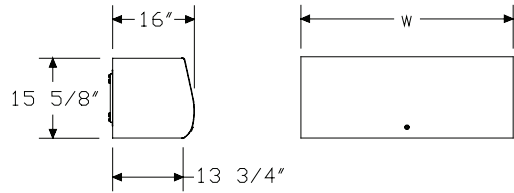

No Lift Handle

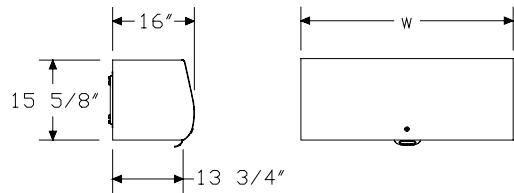

Lift Handle

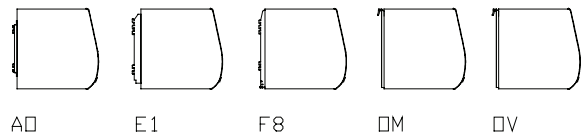

C-Style Flipper Door Unit *continued*

Canvas Office Landscape® Storage

Specification Information

Step 1.
X3750.

Step 2. Width

24	24" wide
30	30" wide
36	36" wide
42	42" wide
48	48" wide

Step 3. Mechanism

SP	standard mechanism
HP	lift-assisted mechanism

Step 4. Lift Handle

N	no lift handle
U	lift handle

Prices for Steps 1-4.

	N	U
X3750. 24 SP	\$618	650
HP	\$1007	1040
30 SP	\$657	688
HP	\$1054	1087
36 SP	\$697	724
HP	\$1100	1133
42 SP	\$746	775
HP	\$1151	1179
48 SP	\$800	831
HP	\$1196	1228

Step 5. Lock Option

KA	keyed alike	-\$10
KD	keyed differently	+\$0

Step 6. Attachment Bracket

AO	for Action Office® system	+\$0
E1	for Ethospace® System	+\$0
F8	for Canvas	+\$0
OM	for Ethospace® off module	+\$0
OV	for Canvas off module	+\$0

Step 7. Case/Lift Handle Finish

8Q	folkstone grey	+\$0
91	white	+\$0
98	studio white	+\$0
BU	black umber	+\$0
CL	cool grey neutral	+\$0
CN	metallic champagne	+\$0
EH	metallic bronze	+\$0
G1	graphite	+\$0
HF	inner tone light	+\$0
LT	light tone	+\$0
LU	soft white	+\$0
MS	metallic silver	+\$0
MT	medium tone	+\$0
WL	sandstone	+\$0
WN	warm grey neutral	+\$0

Step 8. Door Finish

For Action Office® system (AO), Ethospace® System (E1), Canvas (F8), Ethospace® off module (OM), or Canvas off module (OV)

8Q	folkstone grey	+\$0
91	white	+\$0
98	studio white	+\$0
BU	black umber	+\$0
CL	cool grey neutral	+\$0
CN	metallic champagne	+\$0
EH	metallic bronze	+\$0
G1	graphite	+\$0
HF	inner tone light	+\$0
LT	light tone	+\$0
LU	soft white	+\$0
MS	metallic silver	+\$0
MT	medium tone	+\$0
WL	sandstone	+\$0
WN	warm grey neutral	+\$0

C-Style Flipper Door

X3710.

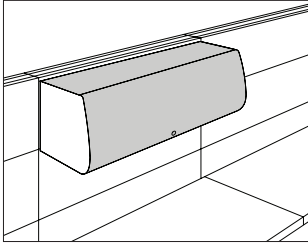

Product Information

Description

This curved flipper door attaches to a C-style shelf to provide top and front closure. It has a painted door with a standard mechanism. A lift handle can be specified to enable easier lifting and closing of the flipper door. Attachment hardware is included. Shipped knocked down. Metallic silver (MS) top has cool grey neutral (CL) lift handle. Metallic champagne (CN) top has warm grey neutral (WN) lift handle.

Notes

Order C-style shelf (X3730.) separately.
 Lift handle conforms to guidelines of Americans with Disabilities Act (ADA).
 To enclose back of unit, order C-style flipper door back panel (X3790.) separately.
 For keyed-alike locks, order lock plugs separately. See Keyed-Alike Information in Appendices.

Dimensions

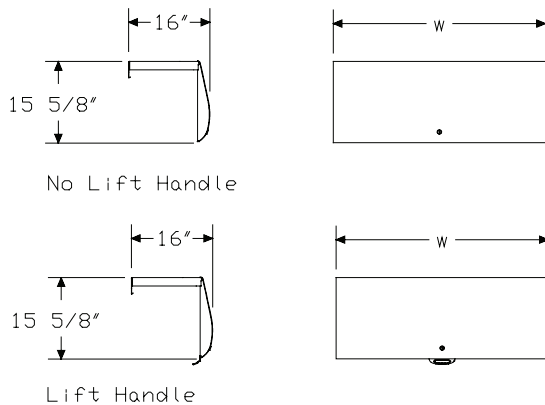

Specification Information

Step 1.

X3710.

Step 2. Width

- 24SP** 24" wide
- 30SP** 30" wide
- 36SP** 36" wide
- 42SP** 42" wide
- 48SP** 48" wide

Step 3. Lift Handle

- N** no lift handle
- U** lift handle

Prices for Steps 1-3.

	N	U
X3710. 24SP	\$386	414
30SP	\$412	446
36SP	\$450	481
42SP	\$486	519
48SP	\$520	550

Step 4. Lock Option

- KA** keyed alike -\$10
- KD** keyed differently +\$0

Step 5. Top/Lift Handle Finish

- 8Q** folkstone grey +\$0
- 91** white +\$0
- 98** studio white +\$0
- BU** black umber +\$0
- CL** cool grey neutral +\$0
- CN** metallic champagne +\$0
- EH** metallic bronze +\$0
- G1** graphite +\$0
- HF** inner tone light +\$0
- LT** light tone +\$0
- LU** soft white +\$0
- MS** metallic silver +\$0
- MT** medium tone +\$0
- WL** sandstone +\$0
- WN** warm grey neutral +\$0

C-Style Flipper Door *continued*

Step 6. Door Finish		
8Q	folkstone grey	+\$0
91	white	+\$0
98	studio white	+\$0
BU	black umber	+\$0
CL	cool grey neutral	+\$0
CN	metallic champagne	+\$0
EH	metallic bronze	+\$0
G1	graphite	+\$0
HF	inner tone light	+\$0
LT	light tone	+\$0
LU	soft white	+\$0
MS	metallic silver	+\$0
MT	medium tone	+\$0
WL	sandstone	+\$0
WN	warm grey neutral	+\$0

C-Style Shelf

X3730.

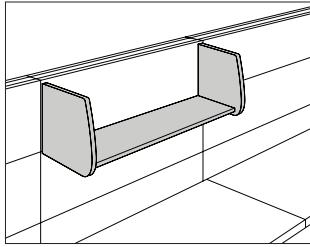

Product Information

Description

This 13^{3/4}"-deep, curved-end-panel shelf hangs from the following products: Action Office® Series 1 or Series 2 panel or wall strips; Canvas on- or off-module frame, off-module upper tile, or wall strips; or Ethospace® on- or off-module frame, off-module upper tile, or wall strips. It stores binders and books. The underside of the shelf accepts a task light. Attachment hardware is included. Shipped knocked down. Shelves can hang from 2 panels or 2 frames with a combined width of 36", 42", or 48". The 36", 42"-, and 48"-wide shelves can also span more than 1 Canvas or Ethospace off-module upper tile.

Metallic silver (MS) shelf has cool grey neutral (CL) end panels. Metallic champagne (CN) and metallic bronze (EH) shelves have warm grey neutral (WN) end panels.

Notes

Canvas or Ethospace off-module upper tile location determines placement of shelf.

Order optional task light separately:

- Energy-efficient task light (G6120.)
- Performance task light (G6114.)
- Utility task light (G6136.)
- Twist™ LED task light (G6160.)

Order optional angled shelf divider (G7330.) separately.

For enclosed storage, order C-style flipper door (X3710.) separately.

Dimensions

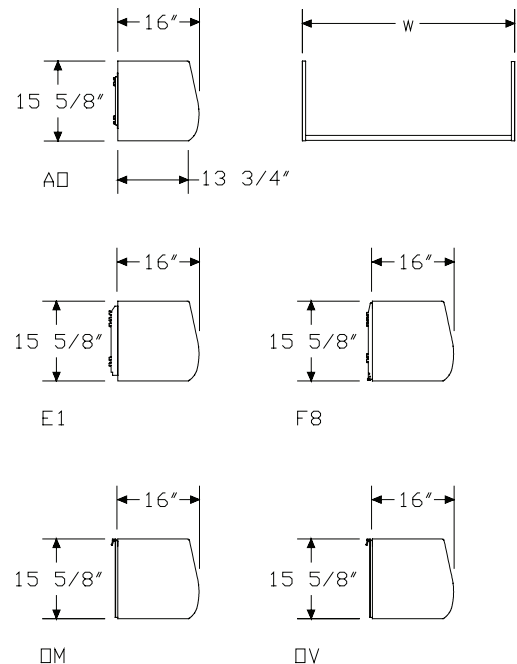

Specification Information

Step 1.

X3730.

Step 2. Width

24	24" wide	
30	30" wide	
36	36" wide	
42	42" wide	
48	48" wide	

Prices for Steps 1-2.

X3730. 24		\$254
30		\$263
36		\$276
42		\$292
48		\$305

Step 3. Attachment Bracket

AO	for Action Office® system	+\$0
E1	for Ethospace® System	+\$0
F8	for Canvas	+\$0
OM	for Ethospace® off module	+\$0
OV	for Canvas off module	+\$0

Step 4. Surface Finish

8Q	folkstone grey	+\$0
91	white	+\$0
98	studio white	+\$0
BU	black umber	+\$0
CL	cool grey neutral	+\$0
G1	graphite	+\$0
HF	inner tone light	+\$0
LT	light tone	+\$0
MT	medium tone	+\$0
EH	metallic bronze	+\$0
CN	metallic champagne	+\$0
MS	metallic silver	+\$0
WL	sandstone	+\$0
LU	soft white	+\$0
WN	warm grey neutral	+\$0

C-Style Flipper Door Back Panel X3790.

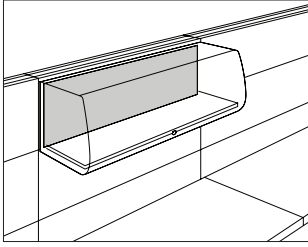

Product Information

Description

This panel attaches to the back of a C-style flipper door unit or C-style flipper door with shelf to enclose the back. Attachment hardware is included.

Dimensions

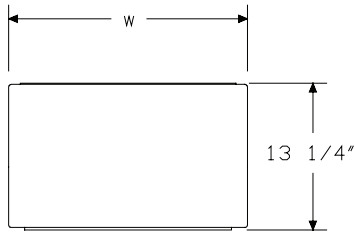

Specification Information

Step 1.

X3790.

Step 2. Width

- 24** 24" wide
- 30** 30" wide
- 36** 36" wide
- 42** 42" wide
- 48** 48" wide

Prices for Steps 1-2.

X3790. 24	\$124
30	\$124
36	\$136
42	\$146
48	\$155

Step 3. Surface Finish

8Q	folkstone grey	+\$0
91	white	+\$0
98	studio white	+\$0
BU	black umber	+\$0
CL	cool grey neutral	+\$0
G1	graphite	+\$0
HF	inner tone light	+\$0
LT	light tone	+\$0
LU	soft white	+\$0
MT	medium tone	+\$0
WL	sandstone	+\$0
WN	warm grey neutral	+\$0
CN	metallic champagne	+\$0
EH	metallic bronze	+\$0
MS	metallic silver	+\$0

E-Style Flipper Door Back Panel E3190.

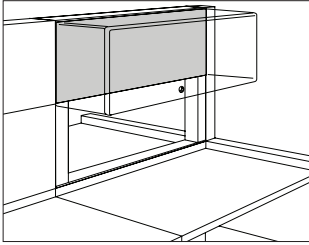

Product Information

Description

This panel attaches to the back of an E-style flipper door unit or a flipper door with shelf to enclose the back. Attachment hardware is included.

Dimensions

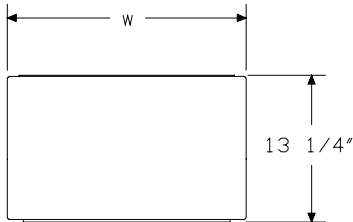

Canvas Office Landscape® Storage

Specification Information

Step 1.

E3190.

Step 2. Width

- 24** 24" wide
- 30** 30" wide
- 36** 36" wide
- 42** 42" wide
- 48** 48" wide

Prices for Steps 1-2.

E3190. 24	\$128
30	\$128
36	\$144
42	\$157
48	\$162

Step 3. Surface Finish

8Q	folkstone grey	+\$0
91	white	+\$0
98	studio white	+\$0
BU	black umber	+\$0
CL	cool grey neutral	+\$0
G1	graphite	+\$0
HF	inner tone light	+\$0
LU	soft white	+\$0
MT	medium tone	+\$0
SG	slate grey	+\$0
WL	sandstone	+\$0
WN	warm grey neutral	+\$0
CN	metallic champagne	+\$0
EH	metallic bronze	+\$0
MS	metallic silver	+\$0

Utility Shelf

E3234.

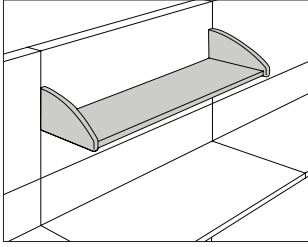

Product Information

Description

This 13"-deep shelf hangs from a frame or wall strips. The underside of the shelf accepts a task light. Attachment hardware is included. Shipped knocked down.

Notes

Specify width of shelf to match width of frame.

Order optional task light separately:

- Energy-efficient task light (G6120.)
- Performance task light (G6114.)
- Utility task light (G6136.)
- Twist™ LED task light (G6160.)

Order optional angled shelf divider (G7330.) separately.

Dimensions

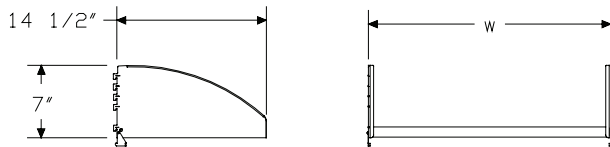

Specification Information

Step 1.

E3234.

Step 2. Width

24	24" wide
30	30" wide
36	36" wide
42	42" wide
48	48" wide
60	60" wide

Prices for Steps 1-2.

E3234. 24	\$156
30	\$165
36	\$176
42	\$184
48	\$205
60	\$253

Step 3. Surface Finish

8Q	folkstone grey	+\$0
91	white	+\$0
98	studio white A	+\$0
BU	black umber	+\$0
CL	cool grey neutral	+\$0
G1	graphite	+\$0
HF	inner tone light	+\$0
LU	soft white	+\$0
MT	medium tone	+\$0
SG	slate grey	+\$0
WL	sandstone	+\$0
WN	warm grey neutral	+\$0
CN	metallic champagne	+\$0
EH	metallic bronze	+\$0
MS	metallic silver	+\$0

Component Brace

X3910.

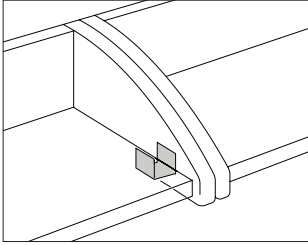

Canvas Office Landscape® Storage

Product Information

Description
 This bracket mounts under C- and E-style flipper door units and shelves and utility shelves (E3234.) hung from stacking panels or frames. The brackets support heavy component loading and reduce deflection of a panel or frame run. Package contains 6.

Notes
 Component brace finish for utility shelf (X3910.2) is black umber (BU).

Dimensions

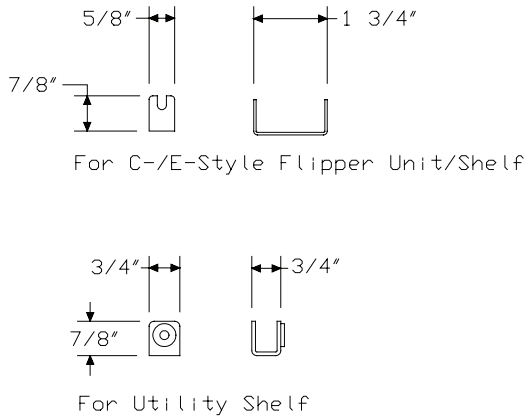

Specification Information

Step 1.

X3910.

Step 2. Usage

- 1 for C-/E-style flipper unit/shelf
- 2 for utility shelf (E3234.)

Prices for Steps 1-2.

X3910. 1	\$45
2	\$45

Step 3. Surface Finish

For C-/E-style flipper unit/shelf (1)

8Q	folkstone grey	+\$0
91	white	+\$0
98	studio white	+\$0
BU	black umber	+\$0
HF	inner tone light	+\$0
LT	light tone	+\$0
LU	soft white	+\$0
MT	medium tone	+\$0
WL	sandstone	+\$0
CN	metallic champagne	+\$0
MS	metallic silver	+\$0

Shelf Divider, Angled

G7330.

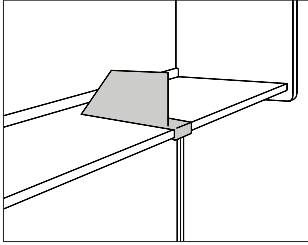

Product Information

Description

This divider attaches to a B-, C-, or E-style shelf to vertically divide books and binders. Package contains 8.

Dimensions

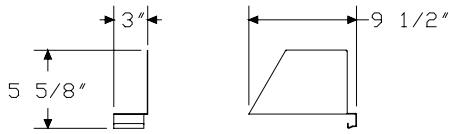

Specification Information

Step 1.

G7330. \$255

Step 2. Surface Finish

8Q	folkstone grey	+\$0
91	white	+\$0
98	studio white	+\$0
BU	black umber	+\$0
CL	cool grey neutral	+\$0
G1	graphite	+\$0
HF	inner tone light	+\$0
LT	light tone	+\$0
LU	soft white	+\$0
MT	medium tone	+\$0
SG	slate grey	+\$0
WL	sandstone	+\$0
WN	warm grey neutral	+\$0
CN	metallic champagne	+\$0
EH	metallic bronze	+\$0
MS	metallic silver	+\$0

Cord Manager

FV984.

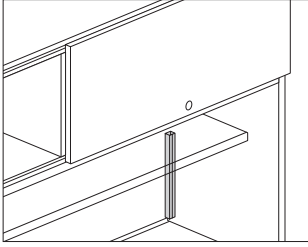

Product Information

Description

This cord manager routes a cord from the underside of a hutch to the surface when a task light is attached. Color is black. Package of 6.

Dimensions

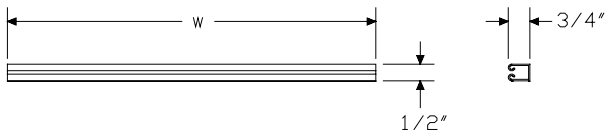

Specification Information

Step 1.

FV984.

Step 2. Height

- 12** 12" high
- 24** 24" high
- 30** 29 1/2" high

Prices for Steps 1-2.

FV984. 12	\$77
24	\$117
30	\$142

Overhead Storage Cabinet, Open FV440.

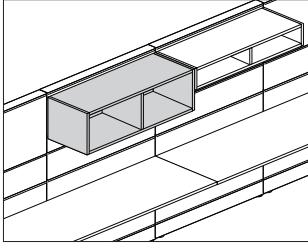

Product Information

Description

This open cabinet hangs from a Canvas Wall frame or attaches to an architectural wall. It accepts a task light.

Notes

24", 30", and 36"-wide cabinets have no divider. 42", 48", 60", 66", and 72"-wide cabinets have a center divider.

Canvas frame connection option (F8) includes attachment hardware.

For wall mount option (WM), attachment hardware must be customer supplied.

Order optional task lights and accessories separately:

- Cable management clips (FT198.) - when cabinet is frame attached
- Cord manager (FV984.) - when cabinet is wall attached
- Performance task light (G6114.xxxxT)
- Utility task light (G6136.xxT)

Dimensions

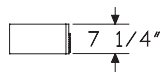
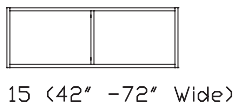
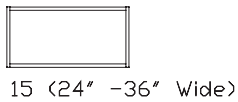
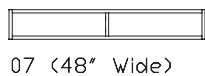
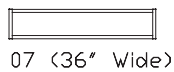
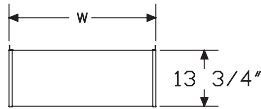

Specification Information

Step 1.

FV440.

Step 2. Attachment Bracket

F8 Canvas frame connection

WM wall mount

Step 3. Height

07 7 1/2" high

15 15" high

Step 4. Width

For 7 1/2" high (07)

36 36" wide

48 48" wide

For Canvas frame connection (F8) with 15" high (15)

24 24" wide

30 30" wide

36 36" wide

42 42" wide

48 48" wide

For wall mount (WM) with 15" high (15)

24 24" wide

30 30" wide

36 36" wide

42 42" wide

48 48" wide

60 60" wide

66 66" wide

72 72" wide

Step 5. Case Material

L laminate

W veneer A

Prices for Steps 1-5.

		24L	24W	30L	30W	36L	36W
FV440. F8	07	—	—	—	—	\$747	1539
	15	\$795	1636	827	1697	858	1759
	WM 07	—	—	—	—	\$802	1594
	15	\$852	1691	881	1753	913	1814

Overhead Storage Cabinet, Open

continued

Canvas Office Landscape® Storage

	42L	42W	48L	48W	60L	60W
FV440. F8 07	—	—	\$810	1662	—	—
15	\$889	1821	920	1882	—	—
WM 07	—	—	\$865	1716	—	—
15	\$945	1875	975	1938	1284	2554
			66L	66W	72L	72W
FV440. WM 15			\$1334	2649	1382	2747

Step 6. Top/Case/Edge Finish

Solid-Color Laminate Top/Case/Thermoplastic Edge

For 24" wide (24), 30" wide (30), 36" wide (36), 42" wide (42), 48" wide (48), 60" wide (60), 66" wide (66), or 72" wide (72) with laminate (L)

8Q	folkstone grey	+\$0
91	white	+\$0
98	studio white	+\$0
CL	cool grey neutral	+\$0
LU	soft white	+\$0
WL	sandstone	+\$0
WN	warm grey neutral	+\$0

Linen Laminate Top/Case/Thermoplastic Edge

For 24" wide (24), 30" wide (30), 36" wide (36), 42" wide (42), 48" wide (48), or 60" wide (60) with laminate (L)

LBM	crisp linen	+\$0
LBN	classic linen	+\$0
LBP	casual linen	+\$0

Mesh Laminate Top/Case/Thermoplastic Edge

For 24" wide (24), 30" wide (30), 36" wide (36), 42" wide (42), 48" wide (48), or 60" wide (60) with laminate (L)

LBK	pewter mesh	+\$0
LBL	steel mesh	+\$0

Twill Laminate Top/Case/Thermoplastic Edge

For 24" wide (24), 30" wide (30), 36" wide (36), 42" wide (42), 48" wide (48), or 60" wide (60) with laminate (L)

LBF	neutral twill	+\$0
LBG	sarum twill	+\$0
LBH	earthen twill	+\$0
LBJ	graphite twill	+\$0
LBQ	white twill	+\$0

Wood-Grain Laminate Top/Case/Thermoplastic Edge

For 24" wide (24), 30" wide (30), 36" wide (36), 42" wide (42), 48" wide (48), or 60" wide (60) with laminate (L)

HM	natural maple	+\$0
HP	light anigre	+\$0
LBA	clear on ash	+\$0
LBR	phantom ecru	+\$0
LBS	phantom cocoa	+\$0
LBU	medium matte walnut	+\$0
LBV	warm grey teak	+\$0
LBB	oak on ash	+\$0
LBC	walnut on ash	+\$0
LBD	dark brown walnut	+\$0
LBE	medium red walnut	+\$0
76	light brown walnut	+\$0
HX	aged cherry	+\$0
HY	walnut on cherry	+\$0

Wood Veneer

For veneer (W)

2U	light brown walnut <input type="checkbox"/>	+\$0
40	dark brown walnut <input type="checkbox"/>	+\$0
ED	aged cherry <input type="checkbox"/>	+\$0
EK	medium red walnut <input type="checkbox"/>	+\$0
EW	medium matte walnut <input type="checkbox"/>	+\$0
ET	clear on ash <input type="checkbox"/>	+\$0
EU	oak on ash <input type="checkbox"/>	+\$0
EV	walnut on ash <input type="checkbox"/>	+\$0
UL	natural maple <input type="checkbox"/>	+\$0
UX	walnut on cherry <input type="checkbox"/>	+\$0

Overhead Storage Cabinet, Partial Enclosure FV441.

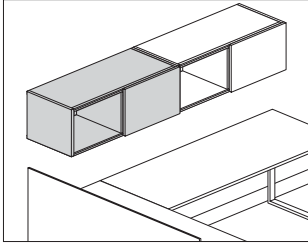

Product Information

Description

This cabinet hangs from a Canvas Wall frame or attaches to an architectural wall and provides partially enclosed storage. The sliding door with optional lock encloses 1 side of the cabinet and can be locked on either side. The cabinet accepts a task light.

Notes

For additional product options, see Vary Easy Program in Appendices.

Grain direction is vertical on veneer and wood-grain laminate door(s).

Cabinets up to 60" wide have 1 door. 66"- and 72"-wide cabinets have 2 doors.

Cabinets up to 60" wide have a center divider. 66"-wide cabinet has 2 dividers and is divided as 1/3, 1/3, 1/3. 72"-wide cabinet has 2 dividers and is divided as 1/4, 1/2, 1/4.

Canvas frame connection option (F8) includes attachment hardware.

For wall mount option (WM), attachment hardware must be customer supplied.

Order optional task lights and accessories separately:

- Cable management clips (FT198.) - when cabinet is frame attached
- Cord manager (FV984.) - when cabinet is wall attached
- Performance task light (G6114.xxxxT)
- Utility task light (G6136.xxT)

For keyed-alike locks, see Keyed-Alike Information in Appendices.

Dimensions

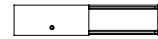
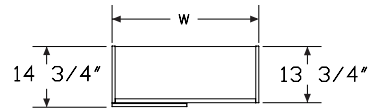

07 (24"-48" Wide)

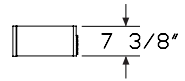

15 (24"-60" Wide)

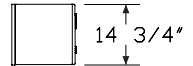

15 (66" Wide)



15 (72" Wide)

Overhead Storage Cabinet, Partial Enclosure *continued*

Canvas Office Landscape® Storage

Specification Information

Step 1.

FV441.

Step 2. Attachment Bracket

F8 Canvas frame connection

WM wall mount

Step 3. Height

07 7½" high

15 15" high

Step 4. Width

For Canvas frame connection (F8) with 7½" high (07)

24 24" wide

30 30" wide

36 36" wide

42 42" wide

48 48" wide

For Canvas frame connection (F8) with 15" high (15)

24 24" wide

30 30" wide

36 36" wide

42 42" wide

48 48" wide

For wall mount (WM) with 7½" high (07)

24 24" wide

30 30" wide

36 36" wide

42 42" wide

48 48" wide

For wall mount (WM) with 15" high (15)

24 24" wide

30 30" wide

36 36" wide

42 42" wide

48 48" wide

60 60" wide

66 66" wide

72 72" wide

Step 5. Case/Door Material

L laminate

C laminate case/veneer door **A**

W veneer **A**

Step 6. Lock

N no lock

L lock

Prices for Steps 1-6.

		24LN	24LL	24CN	24CL	24WN	24WL
FV441. F8	07	\$882	895	1042	1053	1803	1814
	15	\$1008	1019	1189	1199	2057	2070
WM	07	\$938	950	1096	1107	1859	1869
	15	\$1063	1074	1244	1254	2113	2125
		30LN	30LL	30CN	30CL	30WN	30WL
FV441. F8	07	\$918	929	1082	1092	1871	1884
	15	\$1047	1058	1234	1245	2135	2146
WM	07	\$973	983	1137	1148	1928	1939
	15	\$1101	1114	1288	1300	2190	2200
		36LN	36LL	36CN	36CL	36WN	36WL
FV441. F8	07	\$948	958	1118	1129	1938	1948
	15	\$1086	1096	1279	1289	2212	2224
WM	07	\$1003	1014	1172	1185	1992	2003
	15	\$1141	1152	1335	1346	2268	2278
		42LN	42LL	42CN	42CL	42WN	42WL
FV441. F8	07	\$985	997	1163	1173	2012	2025
	15	\$1124	1136	1325	1336	2289	2299
WM	07	\$1042	1053	1218	1230	2070	2080
	15	\$1179	1191	1380	1390	2344	2355
		48LN	48LL	48CN	48CL	48WN	48WL
FV441. F8	07	\$1025	1037	1207	1220	2090	2101
	15	\$1163	1173	1370	1381	2367	2377
WM	07	\$1081	1091	1264	1275	2146	2157
	15	\$1218	1230	1426	1436	2421	2432
		60LN	60LL	60CN	60CL	60WN	60WL
FV441. WM	15	\$1605	1616	1876	1889	3190	3202
		66LN	66LL	66CN	66CL	66WN	66WL
FV441. WM	15	\$1667	1687	1949	1971	3311	3335

Overhead Storage Cabinet, Partial Enclosure *continued*

	72LN	72LL	72CN	72CL	72WN	72WL
FV441. WM 15	\$1727	1750	2020	2043	3432	3454

Step 7. Lock Option

For lock (L)

KA	keyed alike					-\$10
KC	keyed differently, chrome					+\$0

Step 8. Top/Case/Edge Finish

Solid-Color Laminate Top/Case/Thermoplastic Edge

For 24" wide (24), 30" wide (30), 36" wide (36), 42" wide (42), 48" wide (48), 60" wide (60), 66" wide (66), or 72" wide (72) with laminate (L), or laminate case/veneer door (C)

8Q	folkstone grey					+\$0
91	white					+\$0
98	studio white					+\$0
CL	cool grey neutral					+\$0
LU	soft white					+\$0
WL	sandstone					+\$0
WN	warm grey neutral					+\$0

Linen Laminate Top/Case/Thermoplastic Edge

For 24" wide (24), 30" wide (30), 36" wide (36), 42" wide (42), 48" wide (48), or 60" wide (60) with laminate (L), or laminate case/veneer door (C)

LBM	crisp linen					+\$0
LBN	classic linen					+\$0
LBP	casual linen					+\$0

Mesh Laminate Top/Case/Thermoplastic Edge

For 24" wide (24), 30" wide (30), 36" wide (36), 42" wide (42), 48" wide (48), or 60" wide (60) with laminate (L), or laminate case/veneer door (C)

LBK	pewter mesh					+\$0
LBL	steel mesh					+\$0

Twill Laminate Top/Case/Thermoplastic Edge

For 24" wide (24), 30" wide (30), 36" wide (36), 42" wide (42), 48" wide (48), or 60" wide (60) with laminate (L), or laminate case/veneer door (C)

LBF	neutral twill					+\$0
LBG	sarum twill					+\$0
LBH	earthen twill					+\$0
LBJ	graphite twill					+\$0
LBQ	white twill					+\$0

Wood-Grain Laminate Top/Case/Thermoplastic Edge

For 24" wide (24), 30" wide (30), 36" wide (36), 42" wide (42), 48" wide (48), or 60" wide (60) with laminate (L), or laminate case/veneer door (C)

HM	natural maple					+\$0
HP	light anigre					+\$0
LBA	clear on ash					+\$0
LBR	phantom ecru					+\$0
LBS	phantom cocoa					+\$0
LBU	medium matte walnut					+\$0
LBV	warm grey teak					+\$0
LBB	oak on ash					+\$0
LBC	walnut on ash					+\$0
LBD	dark brown walnut					+\$0
LBE	medium red walnut					+\$0
76	light brown walnut					+\$0
HX	aged cherry					+\$0
HY	walnut on cherry					+\$0

Wood Veneer

For veneer (W)

2U	light brown walnut	A				+\$0
40	dark brown walnut	A				+\$0
ED	aged cherry	A				+\$0
EK	medium red walnut	A				+\$0
EW	medium matte walnut	A				+\$0
ET	clear on ash	A				+\$0
EU	oak on ash	A				+\$0
EV	walnut on ash	A				+\$0
UL	natural maple	A				+\$0
UX	walnut on cherry	A				+\$0

Step 9. Door Finish

Solid-Color Laminate

For laminate (L)

8Q	folkstone grey					+\$0
91	white					+\$0
98	studio white					+\$0
CL	cool grey neutral					+\$0
LU	soft white					+\$0
WL	sandstone					+\$0
WN	warm grey neutral					+\$0

Overhead Storage Cabinet, Partial Enclosure *continued*

Canvas Office Landscape® Storage

For laminate (L)

LBM	crisp linen	+\$0
LBN	classic linen	+\$0
LBP	casual linen	+\$0

For laminate (L)

LBK	pewter mesh	+\$0
LBL	steel mesh	+\$0

For laminate (L)

LBF	neutral twill	+\$0
LBG	sarum twill	+\$0
LBH	earthen twill	+\$0
LBJ	graphite twill	+\$0
LBQ	white twill	+\$0

Wood-Grain Laminate

For laminate (L)

HM	natural maple	+\$0
HP	light anigre	+\$0
LBA	clear on ash	+\$0
LBR	phantom ecru	+\$0
LBS	phantom cocoa	+\$0
LBU	medium matte walnut	+\$0
LBV	warm grey teak	+\$0
LBB	oak on ash	+\$0
LBC	walnut on ash	+\$0
LBD	dark brown walnut	+\$0
LBE	medium red walnut	+\$0
76	light brown walnut	+\$0
HX	aged cherry	+\$0
HY	walnut on cherry	+\$0

Wood Veneer

For laminate case/veneer door (C) or veneer (W)

2U	light brown walnut A	+\$0
40	dark brown walnut A	+\$0
ED	aged cherry A	+\$0
EK	medium red walnut A	+\$0
EW	medium matte walnut A	+\$0
ET	clear on ash A	+\$0
EU	oak on ash A	+\$0
EV	walnut on ash A	+\$0
UL	natural maple A	+\$0
UX	walnut on cherry A	+\$0

Overhead Storage Cabinet, Full Enclosure FV442.

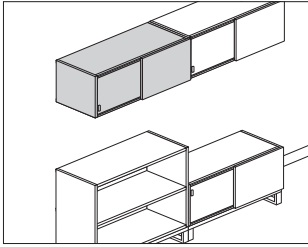

Product Information

Description

This cabinet mounts to a Canvas Wall frame or attaches to an architectural wall and provides fully enclosed storage. It has 2 types of sliding doors; a solid primary door with an optional lock encloses 1 side, and a painted or translucent secondary door encloses the other side. Both doors can slide the entire width of the cabinet. The primary door can be locked on either side. Secondary door handle finish is anodized aluminum. The cabinet accepts a task light.

Notes

For additional product options, see Vary Easy Program in Appendices.
 Grain direction is vertical on veneer and wood-grain laminate door(s).
 Cabinets up to 60" wide have 1 primary and 1 secondary door. 66"-wide cabinet has 2 primary doors and 1 secondary door. 72"-wide cabinet has 2 primary and 2 secondary doors.
 Cabinets up to 60" wide have a center divider. 66"-wide cabinet has 2 dividers and is divided as 1/3, 1/3, 1/3. 72"-wide cabinet has 2 dividers and is divided as 1/4, 1/2, 1/4.
 Canvas frame connection option (F8) includes attachment hardware.
 For wall mount option (WM), attachment hardware must be customer supplied.
 Order optional task lights and accessories separately:
 • Cable management clips (FT198.) - when cabinet is frame attached.
 • Cord manager (FV984.) - when cabinet is wall attached
 • Performance task light (G6114.xxxxT)
 • Utility task light (G6136.xxT)
 For keyed-alike locks, see Keyed-Alike Information in Appendices.

Dimensions

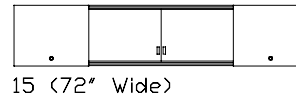
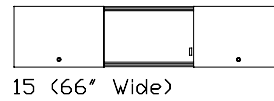
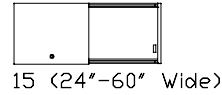
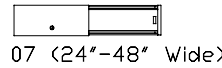
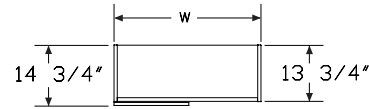

Overhead Storage Cabinet, Full Enclosure *continued*

Specification Information

Step 1.

FV442.

Step 2. Attachment Bracket

F8 Canvas frame connection

WM wall mount

Step 3. Height

07 7½" high

15 15" high

Step 4. Width

For Canvas frame connection (F8) with 7½" high (07)

24 24" wide

30 30" wide

36 36" wide

42 42" wide

48 48" wide

For Canvas frame connection (F8) with 15" high (15)

24 24" wide

30 30" wide

36 36" wide

42 42" wide

48 48" wide

For wall mount (WM) with 7½" high (07)

24 24" wide

30 30" wide

36 36" wide

42 42" wide

48 48" wide

For wall mount (WM) with 15" high (15)

24 24" wide

30 30" wide

36 36" wide

42 42" wide

48 48" wide

60 60" wide

66 66" wide

72 72" wide

Step 5. Case/Primary Door Material

L laminate

C laminate case/veneer door **A**

W veneer **A**

Step 6. Secondary Door Material

A translucent plastic

P painted

Step 7. Lock

N no lock

L lock

Prices for Steps 1-7.

			24LAN	24LAL	24LPN	24LPL	24CAN	24CAL
FV442. F8	07		\$1072	1084	997	1008	1262	1274
	15		\$1222	1232	1136	1147	1437	1448
WM	07		\$1128	1139	1053	1063	1319	1329
	15		\$1276	1286	1191	1201	1492	1503

			24CPN	24CPL	24WAN	24WAL	24WPN	24WPL
FV442. F8	07		\$1173	1186	2178	2188	2028	2039
	15		\$1338	1349	2480	2491	2312	2322
WM	07		\$1230	1241	2233	2243	2083	2093
	15		\$1392	1404	2536	2547	2368	2378

			30LAN	30LAL	30LPN	30LPL	30CAN	30CAL
FV442. F8	07		\$1115	1125	1037	1047	1309	1322
	15		\$1267	1278	1178	1190	1491	1501
WM	07		\$1169	1184	1091	1101	1365	1377
	15		\$1323	1334	1234	1245	1546	1558

			30CPN	30CPL	30WAN	30WAL	30WPN	30WPL
FV442. F8	07		\$1218	1230	2260	2270	2104	2115
	15		\$1388	1399	2572	2585	2399	2409
WM	07		\$1274	1284	2314	2326	2160	2170
	15		\$1444	1455	2628	2640	2454	2464

			36LAN	36LAL	36LPN	36LPL	36CAN	36CAL
FV442. F8	07		\$1148	1159	1067	1079	1352	1363
	15		\$1312	1325	1224	1234	1545	1557
WM	07		\$1202	1214	1123	1135	1407	1419
	15		\$1369	1380	1278	1288	1601	1611

			36CPN	36CPL	36WAN	36WAL	36WPN	36WPL
FV442. F8	07		\$1258	1270	2335	2346	2175	2187
	15		\$1439	1450	2665	2676	2484	2495

Overhead Storage Cabinet, Full
Enclosure *continued*

WM 07	\$1312	1325	2331	2342	2232	2242
15	\$1494	1506	2719	2732	2540	2551
	42LAN	42LAL	42LPN	42LPL	42CAN	42CAL
FV442. F8 07	\$1196	1206	1113	1123	1409	1420
15	\$1359	1372	1266	1277	1600	1610
WM 07	\$1251	1262	1167	1178	1464	1474
15	\$1416	1427	1322	1333	1655	1667
	42CPN	42CPL	42WAN	42WAL	42WPN	42WPL
FV442. F8 07	\$1309	1322	2429	2440	2263	2273
15	\$1490	1500	2757	2770	2580	2592
WM 07	\$1365	1377	2484	2495	2317	2329
15	\$1545	1557	2812	2824	2624	2637
	48LAN	48LAL	48LPN	48LPL	48CAN	48CAL
FV442. F8 07	\$1241	1251	1154	1165	1461	1471
15	\$1406	1418	1308	1321	1654	1665
WM 07	\$1296	1306	1208	1222	1517	1527
15	\$1462	1472	1364	1376	1709	1721
	48CPN	48CPL	48WAN	48WAL	48WPN	48WPL
FV442. F8 07	\$1359	1372	2519	2531	2349	2359
15	\$1540	1552	2850	2860	2655	2667
WM 07	\$1416	1427	2574	2587	2404	2414
15	\$1595	1606	2904	2916	2710	2721
	60LAN	60LAL	60LPN	60LPL	60CAN	60CAL
FV442. WM 15	\$1927	1938	1797	1809	2254	2265
	60CPN	60CPL	60WAN	60WAL	60WPN	60WPL
FV442. WM 15	\$2102	2114	3827	3838	3574	3585
	66LAN	66LAL	66LPN	66LPL	66CAN	66CAL
FV442. WM 15	\$1999	2022	1865	1888	2339	2360
	66CPN	66CPL	66WAN	66WAL	66WPN	66WPL
FV442. WM 15	\$2183	2204	3973	3985	3709	3730
	72LAN	72LAL	72LPN	72LPL	72CAN	72CAL
FV442. WM 15	\$2073	2093	1934	1956	2423	2447
	72CPN	72CPL	72WAN	72WAL	72WPN	72WPL
FV442. WM 15	\$2263	2284	4118	4128	3845	3866

Step 8. Lock Option

For lock (L)

KA	keyed alike	-\$10
KC	keyed differently, chrome	+\$0

Step 9. Top/Case/Edge Finish

Solid-Color Laminate Top/Case/Thermoplastic Edge

For 24" wide (24), 30" wide (30), 36" wide (36), 42" wide (42), 48" wide (48), 60" wide (60), 66" wide (66), or 72" wide (72) with laminate (L), or laminate case/veneer door (C)

8Q	folkstone grey	+\$0
91	white	+\$0
98	studio white	+\$0
CL	cool grey neutral	+\$0
LU	soft white	+\$0
WL	sandstone	+\$0
WN	warm grey neutral	+\$0

Linen Laminate Top/Case/Thermoplastic Edge

For 24" wide (24), 30" wide (30), 36" wide (36), 42" wide (42), 48" wide (48), or 60" wide (60) with laminate (L), or laminate case/veneer door (C)

LBM	crisp linen	+\$0
LBN	classic linen	+\$0
LBP	casual linen	+\$0

Mesh Laminate Top/Case/Thermoplastic Edge

For 24" wide (24), 30" wide (30), 36" wide (36), 42" wide (42), 48" wide (48), or 60" wide (60) with laminate (L), or laminate case/veneer door (C)

LBK	pewter mesh	+\$0
LBL	steel mesh	+\$0

Twill Laminate Top/Case/Thermoplastic Edge

For 24" wide (24), 30" wide (30), 36" wide (36), 42" wide (42), 48" wide (48), or 60" wide (60) with laminate (L), or laminate case/veneer door (C)

LBF	neutral twill	+\$0
LBG	sarum twill	+\$0
LBH	earthen twill	+\$0
LBJ	graphite twill	+\$0
LBQ	white twill	+\$0

Overhead Storage Cabinet, Full Enclosure *continued*

Wood-Grain Laminate Top/Case/Thermoplastic Edge
For 24" wide (24), 30" wide (30), 36" wide (36), 42" wide (42), 48" wide (48), or 60" wide (60) with laminate (L), or laminate case/veneer door (C)

HM	natural maple	+\$0
HP	light anigre	+\$0
LBA	clear on ash	+\$0
LBR	phantom ecru	+\$0
LBS	phantom cocoa	+\$0
LBU	medium matte walnut	+\$0
LBV	warm grey teak	+\$0
LBB	oak on ash	+\$0
LBC	walnut on ash	+\$0
LBD	dark brown walnut	+\$0
LBE	medium red walnut	+\$0
76	light brown walnut	+\$0
HX	aged cherry	+\$0
HY	walnut on cherry	+\$0

Wood Veneer

For veneer (W)

2U	light brown walnut <input type="checkbox"/>	+\$0
40	dark brown walnut <input type="checkbox"/>	+\$0
ED	aged cherry <input type="checkbox"/>	+\$0
EK	medium red walnut <input type="checkbox"/>	+\$0
EW	medium matte walnut <input type="checkbox"/>	+\$0
ET	clear on ash <input type="checkbox"/>	+\$0
EU	oak on ash <input type="checkbox"/>	+\$0
EV	walnut on ash <input type="checkbox"/>	+\$0
UL	natural maple <input type="checkbox"/>	+\$0
UX	walnut on cherry <input type="checkbox"/>	+\$0

Step 10. Primary Door Finish

Solid-Color Laminate

For laminate (L)

8Q	folkstone grey	+\$0
91	white	+\$0
98	studio white	+\$0
CL	cool grey neutral	+\$0
LU	soft white	+\$0
WL	sandstone	+\$0
WN	warm grey neutral	+\$0

For laminate (L)

LBM	crisp linen	+\$0
LBN	classic linen	+\$0
LBP	casual linen	+\$0

For laminate (L)

LBK	pewter mesh	+\$0
LBL	steel mesh	+\$0

For laminate (L)

LBF	neutral twill	+\$0
LBG	sarum twill	+\$0
LBH	earthen twill	+\$0
LBJ	graphite twill	+\$0
LBQ	white twill	+\$0

Wood-Grain Laminate

For laminate (L)

HM	natural maple	+\$0
HP	light anigre	+\$0
LBA	clear on ash	+\$0
LBR	phantom ecru	+\$0
LBS	phantom cocoa	+\$0
LBU	medium matte walnut	+\$0
LBV	warm grey teak	+\$0
LBB	oak on ash	+\$0
LBC	walnut on ash	+\$0
LBD	dark brown walnut	+\$0
LBE	medium red walnut	+\$0
76	light brown walnut	+\$0
HX	aged cherry	+\$0
HY	walnut on cherry	+\$0

Wood Veneer

For laminate case/veneer door (C) or veneer (W)

2U	light brown walnut <input type="checkbox"/>	+\$0
40	dark brown walnut <input type="checkbox"/>	+\$0
ED	aged cherry <input type="checkbox"/>	+\$0
EK	medium red walnut <input type="checkbox"/>	+\$0
EW	medium matte walnut <input type="checkbox"/>	+\$0
ET	clear on ash <input type="checkbox"/>	+\$0
EU	oak on ash <input type="checkbox"/>	+\$0
EV	walnut on ash <input type="checkbox"/>	+\$0
UL	natural maple <input type="checkbox"/>	+\$0
UX	walnut on cherry <input type="checkbox"/>	+\$0

Overhead Storage Cabinet, Full Enclosure *continued*

Step 11. Secondary Door Finish

Translucent Plastic		
<i>For translucent plastic (A)</i>		
J9	opal frosted	+\$0

Bright Sand Texture Paint		
<i>For painted (P)</i>		
8Q	folkstone grey	+\$0
91	white	+\$0
98	studio white	+\$0
CL	cool grey neutral	+\$0
G1	graphite	+\$0
WL	sandstone	+\$0
WN	warm grey neutral	+\$0

Metallic Paint		
<i>For painted (P)</i>		
CN	metallic champagne	+\$0
EH	metallic bronze	+\$0
MS	metallic silver	+\$0

Overhead Storage Cabinet, Thin Top, Open FV445.

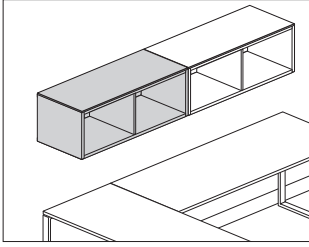

Canvas Office Landscape® Storage

Product Information

Description

This cabinet has a $\frac{3}{8}$ "-high top and hangs from a Canvas Wall frame or attaches to an architectural wall to provide open storage.

Notes

For additional product options, see Vary Easy Program in Appendices. 24", 30", and 36"-wide cabinets have no divider. 42", 48", 60", 66", and 72"-wide cabinets have a center divider.

Canvas frame connection option (F8) includes attachment hardware. For wall mount option (WM), attachment hardware must be customer supplied.

To cover adjacent wall mounted cabinets with a single top, specify cabinets with no top option (NT) and order common thin top, overhead storage (FV490.) separately.

Order optional task lights and accessories separately:

- Cable management clips (FT198.) - when cabinet is frame attached
- Cord manager (FT984.) - when cabinet is wall attached
- Performance task light (G6114.xxxxT)
- Utility task light (G6136.xxT)

To be used adjacent to overhead storage with thin top (FV445., FV44M.)

Dimensions

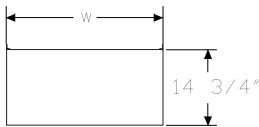

15 (24"-36" Wide)

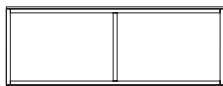
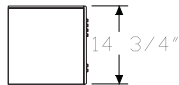

15 (42"-72" Wide)

Specification Information

Step 1.

FV445. A

Step 2. Attachment Bracket

F8 Canvas frame connection A

WM wall mount A

Step 3. Height

15 15" high A

Step 4. Width

For Canvas frame connection (F8) with 15" high (15)

24 24" wide A

30 30" wide A

36 36" wide A

42 42" wide A

48 48" wide A

For wall mount (WM) with 15" high (15)

24 24" wide A

30 30" wide A

36 36" wide A

42 42" wide A

48 48" wide A

60 60" wide A

66 66" wide A

72 72" wide A

Step 5. Case Material

L laminate A

W veneer A

Step 6. Top

NT no top A

03 $\frac{3}{8}$ " laminate top A

04 $\frac{3}{8}$ " veneer top A

Prices for Steps 1-6.

	24LNT	24L03	24L04	24WNT	24W03	24W04
FV445. F8 15	\$844	955	1110	1699	1809	1964
WM 15	\$911	1021	1176	1764	1874	2031
	30LNT	30L03	30L04	30WNT	30W03	30W04
FV445. F8 15	\$880	991	1147	1770	1882	2037
WM 15	\$948	1058	1212	1838	1948	2102

Overhead Storage Cabinet, Thin Top, Open *continued*

	36LNT	36L03	36L04	36WNT	36W03	36W04
FV445. F8 15	\$919	1029	1185	1846	1956	2110
WM 15	\$984	1095	1250	1911	2023	2178
	42LNT	42L03	42L04	42WNT	42W03	42W04
FV445. F8 15	\$928	1065	1259	1853	1991	2185
WM 15	\$993	1133	1326	1919	2057	2251
	48LNT	48L03	48L04	48WNT	48W03	48W04
FV445. F8 15	\$965	1103	1297	1927	2063	2259
WM 15	\$1031	1169	1363	1992	2131	2323
	60LNT	60L03	60L04	60WNT	60W03	60W04
FV445. WM 15	\$1258	1413	1618	2450	2603	2808
	66LNT	66L03	66L04	66WNT	66W03	66W04
FV445. WM 15	\$1310	1466	1671	2555	2708	2913
	72LNT	72L03	72L04	72WNT	72W03	72W04
FV445. WM 15	\$1343	1521	1763	2600	2778	3020

Step 7. Case Finish

Solid-Color Laminate

For 24" wide (24), 30" wide (30), 36" wide (36), 42" wide (42), 48" wide (48), 60" wide (60), 66" wide (66), or 72" wide (72) with laminate (L)

8Q	folkstone grey <input type="checkbox"/>	+\$0
91	white <input type="checkbox"/>	+\$0
98	studio white	+\$0
CL	cool grey neutral <input type="checkbox"/>	+\$0
LU	soft white <input type="checkbox"/>	+\$0
WL	sandstone <input type="checkbox"/>	+\$0
WN	warm grey neutral <input type="checkbox"/>	+\$0

Linen Laminate

For 24" wide (24), 30" wide (30), 36" wide (36), 42" wide (42), 48" wide (48), or 60" wide (60) with laminate (L)

LBM	crisp linen	+\$0
LBN	classic linen	+\$0
LBP	casual linen	+\$0

Mesh Laminate

For 24" wide (24), 30" wide (30), 36" wide (36), 42" wide (42), 48" wide (48), or 60" wide (60) with laminate (L)

LBK	pewter mesh	+\$0
LBL	steel mesh	+\$0

Twill Laminate

For 24" wide (24), 30" wide (30), 36" wide (36), 42" wide (42), 48" wide (48), or 60" wide (60) with laminate (L)

LBF	neutral twill	+\$0
LBG	sarum twill	+\$0
LBH	earthen twill	+\$0
LBJ	graphite twill	+\$0
LBQ	white twill	+\$0

Wood-Grain Laminate

For 24" wide (24), 30" wide (30), 36" wide (36), 42" wide (42), 48" wide (48), or 60" wide (60) with laminate (L)

HM	natural maple <input type="checkbox"/>	+\$0
HP	light anigre <input type="checkbox"/>	+\$0
LBA	clear on ash	+\$0
LBR	phantom ecru	+\$0
LBS	phantom cocoa	+\$0
LBU	medium matte walnut	+\$0
LBV	warm grey teak	+\$0
LBB	oak on ash	+\$0
LBC	walnut on ash	+\$0
LBD	dark brown walnut	+\$0
LBE	medium red walnut	+\$0
76	light brown walnut <input type="checkbox"/>	+\$0
HX	aged cherry <input type="checkbox"/>	+\$0
HY	walnut on cherry <input type="checkbox"/>	+\$0

Wood Veneer

For veneer (W)

2U	light brown walnut <input type="checkbox"/>	+\$0
40	dark brown walnut <input type="checkbox"/>	+\$0
ED	aged cherry <input type="checkbox"/>	+\$0
EK	medium red walnut <input type="checkbox"/>	+\$0
EW	medium matte walnut <input type="checkbox"/>	+\$0
ET	clear on ash <input type="checkbox"/>	+\$0
EU	oak on ash <input type="checkbox"/>	+\$0
EV	walnut on ash <input type="checkbox"/>	+\$0
UL	natural maple <input type="checkbox"/>	+\$0
UX	walnut on cherry <input type="checkbox"/>	+\$0

Overhead Storage Cabinet, Thin Top, Open *continued*

Canvas Office Landscape® Storage

Step 8. Top Finish

Solid-Color Laminate

For 3/8" laminate top (03)

8Q	folkstone grey <input type="checkbox"/>	+\$0
91	white <input type="checkbox"/>	+\$0
98	studio white	+\$0
CL	cool grey neutral <input type="checkbox"/>	+\$0
LU	soft white <input type="checkbox"/>	+\$0
WL	sandstone <input type="checkbox"/>	+\$0
WN	warm grey neutral <input type="checkbox"/>	+\$0

Linen Laminate

For 3/8" laminate top (03)

LBM	crisp linen	+\$0
LBN	classic linen	+\$0
LBP	casual linen	+\$0

Mesh Laminate

For 3/8" laminate top (03)

LBK	pewter mesh	+\$0
LBL	steel mesh	+\$0

Twill Laminate

For 3/8" laminate top (03)

LBF	neutral twill	+\$0
LBG	sarum twill	+\$0
LBH	earthen twill	+\$0
LBJ	graphite twill	+\$0
LBQ	white twill	+\$0

Wood-Grain Laminate

For 3/8" laminate top (03)

HM	natural maple <input type="checkbox"/>	+\$0
HP	light anigre <input type="checkbox"/>	+\$0
LBA	clear on ash	+\$0
LBR	phantom ecru	+\$0
LBS	phantom cocoa	+\$0
LBU	medium matte walnut	+\$0
LBV	warm grey teak	+\$0
LBB	oak on ash	+\$0
LBC	walnut on ash	+\$0
LBD	dark brown walnut	+\$0
LBE	medium red walnut	+\$0
76	light brown walnut <input type="checkbox"/>	+\$0
HX	aged cherry <input type="checkbox"/>	+\$0
HY	walnut on cherry <input type="checkbox"/>	+\$0

Wood Veneer

For 3/8" veneer top (04)

2U	light brown walnut <input type="checkbox"/>	+\$0
40	dark brown walnut <input type="checkbox"/>	+\$0
ED	aged cherry <input type="checkbox"/>	+\$0
EK	medium red walnut <input type="checkbox"/>	+\$0
EW	medium matte walnut <input type="checkbox"/>	+\$0
ET	clear on ash <input type="checkbox"/>	+\$0
EU	oak on ash <input type="checkbox"/>	+\$0
EV	walnut on ash <input type="checkbox"/>	+\$0
UL	natural maple <input type="checkbox"/>	+\$0
UX	walnut on cherry <input type="checkbox"/>	+\$0

Overhead Storage Cabinet, Hinged Doors

FV446.

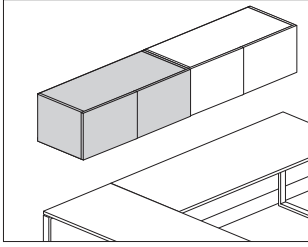

Product Information

Description

This cabinet hangs from a Canvas wall based frame or attaches to an architectural wall to provide fully enclosed storage, or enclosed storage with an open shelf below.

Notes

For additional product options, see Vary Easy Program in Appendices.

Grain direction is vertical on veneer and wood-grain laminate door(s).
15"-high cabinet is fully enclosed. 22"-high cabinet has an open shelf below the doors.

Cabinets up to 48" wide have 2 doors. 60", 66", and 72"-wide cabinets have 4 doors.

Canvas frame connection option (F8) includes attachment hardware.

For wall mount option (WM), attachment hardware must be customer supplied.

Order optional task lights and accessories separately:

- Cable management clips (FT198.) - when cabinet is frame attached
- Cord manager (FV984.) - when cabinet is wall attached
- Performance task light (G6114.xxxxT)
- Utility task light (G6136.xxT)

For keyed-alike locks, see Keyed-Alike Information in Appendices.

Dimensions

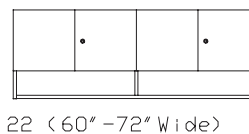
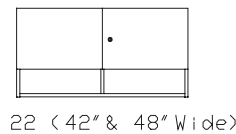
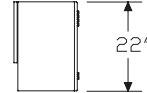
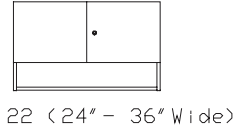
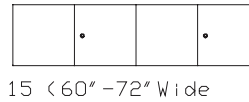
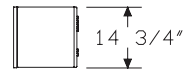
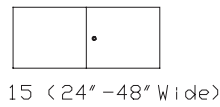
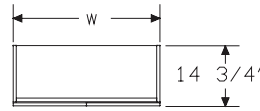

Overhead Storage Cabinet, Hinged Doors *continued*

Specification Information	
Step 1.	
FV446.	<input type="checkbox"/> A
Step 2. Attachment Bracket	
F8	Canvas frame connection <input type="checkbox"/> A
WM	wall mount <input type="checkbox"/> A
Step 3. Height	
15	15" high <input type="checkbox"/> A
22	22" high <input type="checkbox"/> A
Step 4. Width	
<i>For Canvas frame connection (F8) with 15" high (15) or 22" high (22)</i>	
24	24" wide <input type="checkbox"/> A
30	30" wide <input type="checkbox"/> A
36	36" wide <input type="checkbox"/> A
42	42" wide <input type="checkbox"/> A
48	48" wide <input type="checkbox"/> A
<i>For wall mount (WM) with 15" high (15) or 22" high (22)</i>	
24	24" wide <input type="checkbox"/> A
30	30" wide <input type="checkbox"/> A
36	36" wide <input type="checkbox"/> A
42	42" wide <input type="checkbox"/> A
48	48" wide <input type="checkbox"/> A
60	60" wide <input type="checkbox"/> A
66	66" wide <input type="checkbox"/> A
72	72" wide <input type="checkbox"/> A
Step 5. Case/Door Material	
L	laminated case and doors <input type="checkbox"/> A
C	laminated case/veneer doors <input type="checkbox"/> A
W	veneer case and doors <input type="checkbox"/> A
Step 6. Lock	
L	lock <input type="checkbox"/> A
N	no lock <input type="checkbox"/> A

Prices for Steps 1-6.							
		24LL	24LN	24CL	24CN	24WL	24WN
FV446. F8	15	\$1093	1083	1323	1310	2423	2412
	22	\$1283	1267	1534	1524	2771	2754
	WM 15	\$1149	1138	1378	1367	2479	2467
	22	\$1378	1367	1653	1642	2974	2964

		30LL	30LN	30CL	30CN	30WL	30WN
FV446. F8	15	\$1136	1124	1374	1361	2514	2503
	22	\$1333	1316	1598	1580	2873	2858
	WM 15	\$1191	1179	1429	1418	2569	2559
	22	\$1429	1418	1713	1703	3082	3072
		36LL	36LN	36CL	36CN	36WL	36WN
FV446. F8	15	\$1176	1165	1422	1411	2602	2592
	22	\$1381	1364	1656	1640	2980	2965
	WM 15	\$1232	1222	1477	1466	2658	2647
	22	\$1477	1466	1772	1761	3188	3178
		42LL	42LN	42CL	42CN	42WL	42WN
FV446. F8	15	\$1218	1206	1472	1462	2694	2682
	22	\$1378	1367	1653	1642	2974	2964
	WM 15	\$1274	1262	1528	1518	2749	2738
	22	\$1528	1518	1834	1822	3298	3288
		48LL	48LN	48CL	48CN	48WL	48WN
FV446. F8	15	\$1260	1249	1524	1512	2784	2774
	22	\$1429	1418	1713	1703	3082	3072
	WM 15	\$1316	1304	1578	1568	2839	2828
	22	\$1578	1568	1894	1884	3406	3396
		60LL	60LN	60CL	60CN	60WL	60WN
FV446. WM	15	\$1733	1711	2080	2057	3743	3720
	22	\$2080	2057	2495	2474	4490	4469
		66LL	66LN	66CL	66CN	66WL	66WN
FV446. WM	15	\$1798	1777	2158	2136	3883	3861
	22	\$2158	2136	2590	2567	4660	4636
		72LL	72LN	72CL	72CN	72WL	72WN
FV446. WM	15	\$1865	1843	2238	2216	4026	4005
	22	\$2238	2216	2684	2663	4831	4810

Step 7. Lock Option		
<i>For lock (L)</i>		
KA	keyed alike <input type="checkbox"/> A	-\$10
KC	keyed differently, chrome <input type="checkbox"/> A	+\$0
KD	keyed differently, black <input type="checkbox"/> A	+\$0

Overhead Storage Cabinet, Hinged Doors *continued*

Step 8. Case Finish

Solid-Color Laminate

For 24" wide (24), 30" wide (30), 36" wide (36), 42" wide (42), 48" wide (48), 60" wide (60), 66" wide (66), or 72" wide (72) with laminate case and doors (L), or laminate case/veneer doors (C)

8Q	folkstone grey <input type="checkbox"/>	+\$0
91	white <input type="checkbox"/>	+\$0
98	studio white	+\$0
CL	cool grey neutral <input type="checkbox"/>	+\$0
LU	soft white <input type="checkbox"/>	+\$0
WL	sandstone <input type="checkbox"/>	+\$0
WN	warm grey neutral <input type="checkbox"/>	+\$0

Linen Laminate

For 24" wide (24), 30" wide (30), 36" wide (36), 42" wide (42), 48" wide (48), or 60" wide (60) with laminate case and doors (L), or laminate case/veneer doors (C)

LBM	crisp linen	+\$0
LBN	classic linen	+\$0
LBP	casual linen	+\$0

Mesh Laminate

For 24" wide (24), 30" wide (30), 36" wide (36), 42" wide (42), 48" wide (48), or 60" wide (60) with laminate case and doors (L), or laminate case/veneer doors (C)

LBK	pewter mesh	+\$0
LBL	steel mesh	+\$0

Twill Laminate

For 24" wide (24), 30" wide (30), 36" wide (36), 42" wide (42), 48" wide (48), or 60" wide (60) with laminate case and doors (L), or laminate case/veneer doors (C)

LBF	neutral twill	+\$0
LBG	sarum twill	+\$0
LBH	earthen twill	+\$0
LBJ	graphite twill	+\$0
LBQ	white twill	+\$0

Wood-Grain Laminate

For 24" wide (24), 30" wide (30), 36" wide (36), 42" wide (42), 48" wide (48), or 60" wide (60) with laminate case and doors (L), or laminate case/veneer doors (C)

HM	natural maple <input type="checkbox"/>	+\$0
HP	light anigre <input type="checkbox"/>	+\$0
LBA	clear on ash	+\$0
LBR	phantom ecru	+\$0
LBS	phantom cocoa	+\$0
LBU	medium matte walnut	+\$0
LBV	warm grey teak	+\$0
LBB	oak on ash	+\$0
LBC	walnut on ash	+\$0
LBD	dark brown walnut	+\$0
LBE	medium red walnut	+\$0
76	light brown walnut <input type="checkbox"/>	+\$0
HX	aged cherry <input type="checkbox"/>	+\$0
HY	walnut on cherry <input type="checkbox"/>	+\$0

Wood Veneer

For veneer case and doors (W)

2U	light brown walnut <input type="checkbox"/>	+\$0
40	dark brown walnut <input type="checkbox"/>	+\$0
ED	aged cherry <input type="checkbox"/>	+\$0
EK	medium red walnut <input type="checkbox"/>	+\$0
EW	medium matte walnut <input type="checkbox"/>	+\$0
ET	clear on ash <input type="checkbox"/>	+\$0
EU	oak on ash <input type="checkbox"/>	+\$0
EV	walnut on ash <input type="checkbox"/>	+\$0
UL	natural maple <input type="checkbox"/>	+\$0
UX	walnut on cherry <input type="checkbox"/>	+\$0

Step 9. Door Finish

Solid-Color Laminate

For laminate case and doors (L)

8Q	folkstone grey <input type="checkbox"/>	+\$0
91	white <input type="checkbox"/>	+\$0
98	studio white	+\$0
CL	cool grey neutral <input type="checkbox"/>	+\$0
LU	soft white <input type="checkbox"/>	+\$0
WL	sandstone <input type="checkbox"/>	+\$0
WN	warm grey neutral <input type="checkbox"/>	+\$0

Overhead Storage Cabinet, Hinged Doors *continued*

Canvas Office Landscape® Storage

Linen Laminate

For laminate case and doors (L)

LBM	crisp linen	+\$0
LBN	classic linen	+\$0
LBP	casual linen	+\$0

Mesh Laminate

For laminate case and doors (L)

LBK	pewter mesh	+\$0
LBL	steel mesh	+\$0

Twill Laminate

For laminate case and doors (L)

LBF	neutral twill	+\$0
LBG	sarum twill	+\$0
LBH	earthen twill	+\$0
LBJ	graphite twill	+\$0
LBQ	white twill	+\$0

Wood-Grain Laminate

For laminate case and doors (L)

HM	natural maple A	+\$0
HP	light anigre A	+\$0
LBA	clear on ash	+\$0
LBR	phantom ecru	+\$0
LBS	phantom cocoa	+\$0
LBU	medium matte walnut	+\$0
LBV	warm grey teak	+\$0
LBB	oak on ash	+\$0
LBC	walnut on ash	+\$0
LBD	dark brown walnut	+\$0
LBE	medium red walnut	+\$0
76	light brown walnut A	+\$0
HX	aged cherry A	+\$0
HY	walnut on cherry A	+\$0

Wood Veneer

For laminate case/veneer doors (C) or veneer case and doors (W)

2U	light brown walnut A	+\$0
40	dark brown walnut A	+\$0
ED	aged cherry A	+\$0
EK	medium red walnut A	+\$0
EW	medium matte walnut A	+\$0
ET	clear on ash A	+\$0
EU	oak on ash A	+\$0
EV	walnut on ash A	+\$0
UL	natural maple A	+\$0
UX	walnut on cherry A	+\$0

Overhead Storage Cabinet, Thin FV44M.
Top with Hinged Doors

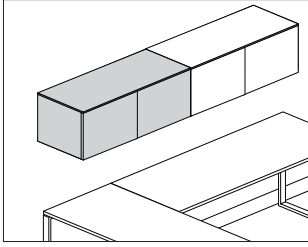

Product Information

Description

This cabinet has a 3/8"-high top and hangs from a Canvas wall based frame or attaches to an architectural wall. It provides fully enclosed storage or enclosed storage with an open shelf below.

Notes

For additional product options, see Vary Easy Program in Appendices.

Grain direction is vertical on veneer and wood-grain laminate door(s). 15"-high cabinet is fully enclosed. 22"-high cabinet has an open shelf below the doors.

Cabinets up to 48" wide have 2 doors. 60", 66", and 72"-wide cabinets have 4 doors.

Canvas frame connection option (F8) includes attachment hardware.

For wall mount option (WM), attachment hardware must be customer supplied.

To cover adjacent wall mounted cabinets with a single top, specify cabinets with no top option (NT) and order common thin top, overhead storage (FV490.) separately.

Order optional accessories separately:

- Cable management clips (FT198.) - when cabinet is frame attached
- Cord manager (FT984.) - when cabinet is wall attached
- Performance task light (G6114.xxxT)
- Utility task light (G6136.xxT)

To be used adjacent to overhead storage with thin top (FV445., FV44M.)

For keyed-alike locks, see Keyed-Alike Information in Appendices.

Dimensions

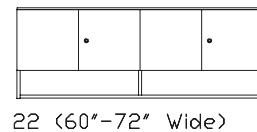
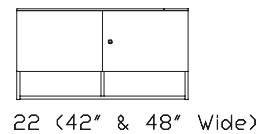
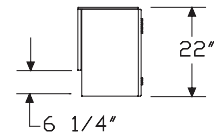
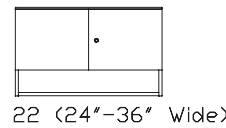
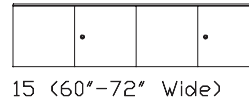
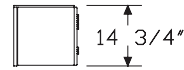
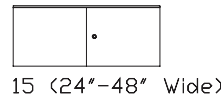
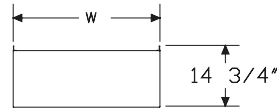

Overhead Storage Cabinet, Thin Top with Hinged Doors *continued*

Specification Information

Step 1.

FV44M. A

Step 2. Attachment Bracket

F8 Canvas frame connection A

WM wall mount A

Step 3. Height

15 15" high A

22 22" high A

Step 4. Width

For Canvas frame connection (F8) with 15" high (15) or 22" high (22)

24 24" wide A

30 30" wide A

36 36" wide A

42 42" wide A

48 48" wide A

For wall mount (WM) with 15" high (15) or 22" high (22)

24 24" wide A

30 30" wide A

36 36" wide A

42 42" wide A

48 48" wide A

60 60" wide A

66 66" wide A

72 72" wide A

Step 5. Case/Door Material

L laminate case and doors A

C laminate case/veneer doors A

W veneer case and doors A

Step 6. Top

NT no top A

03 3/8" laminate top A

04 3/8" veneer top A

Step 7. Lock

L lock A

N no lock A

Prices for Steps 1-7.

		24LNTL	24LNTN	24L03L	24L03N	24L04L	24L04N
FV44M. F8	15	\$1092	1081	1202	1191	1374	1360
	22	\$1275	1264	1385	1375	1540	1529
WM	15	\$1153	1141	1264	1251	1434	1422
	22	\$1405	1392	1517	1503	1685	1674
		24CNTL	24CNTN	24C03L	24C03N	24C04L	24C04N
FV44M. F8	15	\$1345	1333	1455	1443	1626	1613
	22	\$1552	1540	1662	1651	1816	1805
WM	15	\$1405	1392	1517	1503	1685	1674
	22	\$1708	1696	1818	1806	1989	1977
		24WNTL	24WNTN	24W03L	24W03N	24W04L	24W04N
FV44M. F8	15	\$2384	2373	2495	2483	2666	2653
	22	\$2724	2713	2835	2824	2990	2978
WM	15	\$2447	2433	2557	2544	2726	2714
	22	\$2991	2978	3102	3089	3271	3260
		30LNTL	30LNTN	30L03L	30L03N	30L04L	30L04N
FV44M. F8	15	\$1139	1126	1249	1238	1420	1407
	22	\$1341	1331	1452	1441	1606	1595
WM	15	\$1199	1188	1309	1298	1481	1468
	22	\$1461	1448	1571	1560	1742	1729
		30CNTL	30CNTN	30C03L	30C03N	30C04L	30C04N
FV44M. F8	15	\$1399	1387	1510	1497	1680	1669
	22	\$1631	1620	1742	1730	1896	1886
WM	15	\$1461	1448	1571	1560	1742	1729
	22	\$1775	1762	1886	1872	2055	2044
		30WNTL	30WNTN	30W03L	30W03N	30W04L	30W04N
FV44M. F8	15	\$2484	2473	2595	2584	2764	2753
	22	\$2868	2857	2978	2968	3133	3122
WM	15	\$2545	2533	2655	2644	2826	2813
	22	\$3110	3097	3220	3208	3391	3378
		36LNTL	36LNTN	36L03L	36L03N	36L04L	36L04N
FV44M. F8	15	\$1184	1170	1294	1281	1464	1452
	22	\$1376	1364	1486	1474	1641	1630
WM	15	\$1244	1232	1354	1342	1525	1512
	22	\$1515	1501	1626	1613	1795	1783
		36CNTL	36CNTN	36C03L	36C03N	36C04L	36C04N
FV44M. F8	15	\$1454	1442	1565	1553	1735	1723
	22	\$1672	1660	1782	1770	1938	1927

Overhead Storage Cabinet, Thin Top with Hinged Doors *continued*

WM 15	\$1515	1501	1626	1613	1795	1783
22	\$1839	1826	1949	1938	2119	2107
	36WNTL	36WNTN	36W03L	36W03N	36W04L	36W04N
FV44M. F8 15	\$2581	2569	2692	2680	2862	2851
22	\$2942	2932	3053	3042	3207	3197
WM 15	\$2643	2631	2753	2742	2923	2911
22	\$3227	3215	3339	3325	3508	3496
	42LNTL	42LNTN	42L03L	42L03N	42L04L	42L04N
FV44M. F8 15	\$1201	1190	1340	1328	1554	1541
22	\$1378	1365	1517	1503	1685	1674
WM 15	\$1262	1250	1400	1388	1614	1602
22	\$1542	1530	1680	1669	1894	1882
	42CNTL	42CNTN	42C03L	42C03N	42C04L	42C04N
FV44M. F8 15	\$1482	1469	1620	1607	1834	1821
22	\$1680	1669	1818	1806	1989	1977
WM 15	\$1542	1530	1680	1669	1894	1882
22	\$1877	1866	2016	2004	2229	2217
	42WNTL	42WNTN	42W03L	42W03N	42W04L	42W04N
FV44M. F8 15	\$2611	2599	2750	2738	2963	2949
22	\$2964	2951	3102	3089	3271	3260
WM 15	\$2672	2661	2810	2798	3022	3011
22	\$3275	3264	3414	3402	3628	3616
	48LNTL	48LNTN	48L03L	48L03N	48L04L	48L04N
FV44M. F8 15	\$1248	1236	1386	1375	1599	1586
22	\$1433	1421	1571	1560	1742	1729
WM 15	\$1308	1297	1447	1435	1659	1648
22	\$1598	1584	1736	1724	1949	1938
	48CNTL	48CNTN	48C03L	48C03N	48C04L	48C04N
FV44M. F8 15	\$1537	1525	1675	1663	1889	1875
22	\$1748	1735	1886	1872	2055	2044
WM 15	\$1598	1584	1736	1724	1949	1938
22	\$1945	1933	2083	2072	2295	2282
	48WNTL	48WNTN	48W03L	48W03N	48W04L	48W04N
FV44M. F8 15	\$2710	2699	2850	2837	3064	3050
22	\$3082	3071	3220	3208	3391	3378
WM 15	\$2773	2759	2909	2897	3123	3111
22	\$3397	3385	3534	3523	3747	3735

	60LNTL	60LNTN	60L03L	60L03N	60L04L	60L04N
FV44M. WM 15	\$1753	1728	1906	1884	2132	2107
22	\$2133	2108	2288	2264	2513	2489
	60CNTL	60CNTN	60C03L	60C03N	60C04L	60C04N
FV44M. WM 15	\$2133	2108	2288	2264	2513	2501
22	\$2591	2566	2746	2720	2970	2945
	60WNTL	60WNTN	60W03L	60W03N	60W04L	60W04N
FV44M. WM 15	\$3736	3712	3890	3866	4116	4092
22	\$4559	4533	4713	4689	4938	4915
	66LNTL	66LNTN	66L03L	66L03N	66L04L	66L04N
FV44M. WM 15	\$1824	1799	1979	1954	2203	2180
22	\$2219	2194	2374	2350	2599	2574
	66CNTL	66CNTN	66C03L	66C03N	66C04L	66C04N
FV44M. WM 15	\$2219	2194	2374	2350	2599	2574
22	\$2694	2669	2849	2824	3074	3049
	66WNTL	66WNTN	66W03L	66W03N	66W04L	66W04N
FV44M. WM 15	\$3891	3868	4047	4022	4272	4248
22	\$4745	4721	4900	4876	5124	5100
	72LNTL	72LNTN	72L03L	72L03N	72L04L	72L04N
FV44M. WM 15	\$1874	1851	2052	2028	2319	2295
22	\$2284	2261	2461	2437	2729	2704
	72CNTL	72CNTN	72C03L	72C03N	72C04L	72C04N
FV44M. WM 15	\$2284	2261	2461	2437	2729	2704
22	\$2777	2752	2953	2929	3220	3197
	72WNTL	72WNTN	72W03L	72W03N	72W04L	72W04N
FV44M. WM 15	\$3985	3961	4161	4138	4429	4405
22	\$4870	4845	5045	5023	5314	5290

Step 8. Lock Option

For lock (L)

KA	keyed alike <input type="checkbox"/>	-\$10
KC	keyed differently, chrome <input type="checkbox"/>	+\$0
KD	keyed differently, black <input type="checkbox"/>	+\$0

Overhead Storage Cabinet, Thin Top with Hinged Doors *continued*

Step 9. Case Finish

Solid-Color Laminate

For 24" wide (24), 30" wide (30), 36" wide (36), 42" wide (42), 48" wide (48), 60" wide (60), 66" wide (66), or 72" wide (72) with laminate case and doors (L), or laminate case/veneer doors (C)

8Q	folkstone grey <input type="checkbox"/>	+\$0
91	white <input type="checkbox"/>	+\$0
98	studio white	+\$0
CL	cool grey neutral <input type="checkbox"/>	+\$0
LU	soft white <input type="checkbox"/>	+\$0
WL	sandstone <input type="checkbox"/>	+\$0
WN	warm grey neutral <input type="checkbox"/>	+\$0

Linen Laminate

For 24" wide (24), 30" wide (30), 36" wide (36), 42" wide (42), 48" wide (48), or 60" wide (60) with laminate case and doors (L), or laminate case/veneer doors (C)

LBM	crisp linen	+\$0
LBN	classic linen	+\$0
LBP	casual linen	+\$0

Mesh Laminate

For 24" wide (24), 30" wide (30), 36" wide (36), 42" wide (42), 48" wide (48), or 60" wide (60) with laminate case and doors (L), or laminate case/veneer doors (C)

LBK	pewter mesh	+\$0
LBL	steel mesh	+\$0

Twill Laminate

For 24" wide (24), 30" wide (30), 36" wide (36), 42" wide (42), 48" wide (48), or 60" wide (60) with laminate case and doors (L), or laminate case/veneer doors (C)

LBF	neutral twill	+\$0
LBG	sarum twill	+\$0
LBH	earthen twill	+\$0
LBJ	graphite twill	+\$0
LBQ	white twill	+\$0

Wood-Grain Laminate

For 24" wide (24), 30" wide (30), 36" wide (36), 42" wide (42), 48" wide (48), or 60" wide (60) with laminate case and doors (L), or laminate case/veneer doors (C)

HM	natural maple <input type="checkbox"/>	+\$0
HP	light anigre <input type="checkbox"/>	+\$0
LBA	clear on ash	+\$0
LBR	phantom ecru	+\$0
LBS	phantom cocoa	+\$0
LBU	medium matte walnut	+\$0
LBV	warm grey teak	+\$0
LBB	oak on ash	+\$0
LBC	walnut on ash	+\$0
LBD	dark brown walnut	+\$0
LBE	medium red walnut	+\$0
76	light brown walnut <input type="checkbox"/>	+\$0
HX	aged cherry <input type="checkbox"/>	+\$0
HY	walnut on cherry <input type="checkbox"/>	+\$0

Wood Veneer

For veneer case and doors (W)

2U	light brown walnut <input type="checkbox"/>	+\$0
40	dark brown walnut <input type="checkbox"/>	+\$0
ED	aged cherry <input type="checkbox"/>	+\$0
EK	medium red walnut <input type="checkbox"/>	+\$0
EW	medium matte walnut <input type="checkbox"/>	+\$0
ET	clear on ash <input type="checkbox"/>	+\$0
EU	oak on ash <input type="checkbox"/>	+\$0
EV	walnut on ash <input type="checkbox"/>	+\$0
UL	natural maple <input type="checkbox"/>	+\$0
UX	walnut on cherry <input type="checkbox"/>	+\$0

Step 10. Door Finish

Solid-Color Laminate

For laminate case and doors (L)

8Q	folkstone grey <input type="checkbox"/>	+\$0
91	white <input type="checkbox"/>	+\$0
98	studio white	+\$0
CL	cool grey neutral <input type="checkbox"/>	+\$0
LU	soft white <input type="checkbox"/>	+\$0
WL	sandstone <input type="checkbox"/>	+\$0
WN	warm grey neutral <input type="checkbox"/>	+\$0

Overhead Storage Cabinet, Thin Top with Hinged Doors *continued*

Linen Laminate		
<i>For laminate case and doors (L)</i>		
LBM	crisp linen	+\$0
LBN	classic linen	+\$0
LBP	casual linen	+\$0
Mesh Laminate		
<i>For laminate case and doors (L)</i>		
LBK	pewter mesh	+\$0
LBL	steel mesh	+\$0
Twill Laminate		
<i>For laminate case and doors (L)</i>		
LBF	neutral twill	+\$0
LBG	sarum twill	+\$0
LBH	earthen twill	+\$0
LBJ	graphite twill	+\$0
LBQ	white twill	+\$0
Wood-Grain Laminate		
<i>For laminate case and doors (L)</i>		
HM	natural maple <input type="checkbox"/>	+\$0
HP	light anigre <input type="checkbox"/>	+\$0
LBA	clear on ash	+\$0
LBR	phantom ecru	+\$0
LBS	phantom cocoa	+\$0
LBU	medium matte walnut	+\$0
LBV	warm grey teak	+\$0
LBB	oak on ash	+\$0
LBC	walnut on ash	+\$0
LBD	dark brown walnut	+\$0
LBE	medium red walnut	+\$0
76	light brown walnut <input type="checkbox"/>	+\$0
HX	aged cherry <input type="checkbox"/>	+\$0
HY	walnut on cherry <input type="checkbox"/>	+\$0

Wood Veneer		
<i>For laminate case/veneer doors (C) or veneer case and doors (W)</i>		
2U	light brown walnut <input type="checkbox"/>	+\$0
40	dark brown walnut <input type="checkbox"/>	+\$0
ED	aged cherry <input type="checkbox"/>	+\$0
EK	medium red walnut <input type="checkbox"/>	+\$0
EW	medium matte walnut <input type="checkbox"/>	+\$0
ET	clear on ash <input type="checkbox"/>	+\$0
EU	oak on ash <input type="checkbox"/>	+\$0
EV	walnut on ash <input type="checkbox"/>	+\$0
UL	natural maple <input type="checkbox"/>	+\$0
UX	walnut on cherry <input type="checkbox"/>	+\$0

Step 11. Top Finish

Solid-Color Laminate		
<i>For 3/8" laminate top (03)</i>		
8Q	folkstone grey <input type="checkbox"/>	+\$0
91	white <input type="checkbox"/>	+\$0
98	studio white	+\$0
CL	cool grey neutral <input type="checkbox"/>	+\$0
LU	soft white <input type="checkbox"/>	+\$0
WL	sandstone <input type="checkbox"/>	+\$0
WN	warm grey neutral <input type="checkbox"/>	+\$0

Linen Laminate		
<i>For 3/8" laminate top (03)</i>		
LBM	crisp linen	+\$0
LBN	classic linen	+\$0
LBP	casual linen	+\$0

Mesh Laminate		
<i>For 3/8" laminate top (03)</i>		
LBK	pewter mesh	+\$0
LBL	steel mesh	+\$0

Twill Laminate		
<i>For 3/8" laminate top (03)</i>		
LBF	neutral twill	+\$0
LBG	sarum twill	+\$0
LBH	earthen twill	+\$0
LBJ	graphite twill	+\$0
LBQ	white twill	+\$0

Overhead Storage Cabinet, Thin Top with Hinged Doors *continued*

Wood-Grain Laminate

For 3/8" laminate top (03)

HM	natural maple <input type="checkbox"/> A	+\$0
HP	light anigre <input type="checkbox"/> A	+\$0
LBA	clear on ash	+\$0
LBR	phantom ecru	+\$0
LBS	phantom cocoa	+\$0
LBU	medium matte walnut	+\$0
LBV	warm grey teak	+\$0
LBB	oak on ash	+\$0
LBC	walnut on ash	+\$0
LBD	dark brown walnut	+\$0
LBE	medium red walnut	+\$0
76	light brown walnut <input type="checkbox"/> A	+\$0
HX	aged cherry <input type="checkbox"/> A	+\$0
HY	walnut on cherry <input type="checkbox"/> A	+\$0

Wood Veneer

For 3/8" veneer top (04)

2U	light brown walnut <input type="checkbox"/> A	+\$0
40	dark brown walnut <input type="checkbox"/> A	+\$0
ED	aged cherry <input type="checkbox"/> A	+\$0
EK	medium red walnut <input type="checkbox"/> A	+\$0
EW	medium matte walnut <input type="checkbox"/> A	+\$0
ET	clear on ash <input type="checkbox"/> A	+\$0
EU	oak on ash <input type="checkbox"/> A	+\$0
EV	walnut on ash <input type="checkbox"/> A	+\$0
UL	natural maple <input type="checkbox"/> A	+\$0
UX	walnut on cherry <input type="checkbox"/> A	+\$0

Common Thin Top, Overhead Storage

FV490.

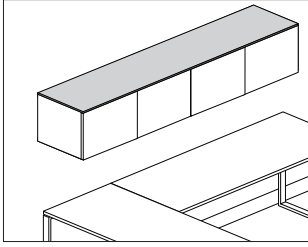

Product Information

Description

This 3/8"-high top covers 2 or 3 adjacent wall mounted overhead storage cabinets. It is available as laminate or veneer. Attachment hardware included.

Notes

For additional product options, see Vary Easy Program in Appendices.
 Top is designed to be used on overhead storage cabinets attached to an architectural wall only.
 For use on wall mounted overhead storage cabinet, thin top with hinged doors (FV44M.) or overhead storage cabinet, thin top, open (FV445.) when cabinets are specified with no top (NT) option.
 Specify width of top to match the combined width of wall mounted storage cabinets.

Dimensions

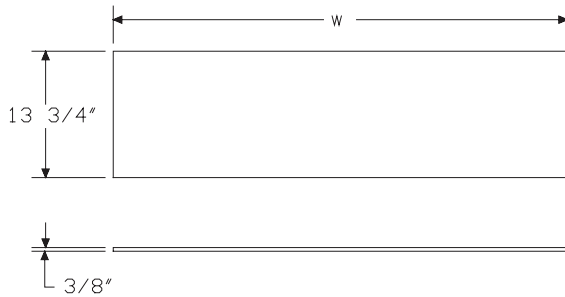

Specification Information

Step 1.

FV490. [A]

Step 2. Number of Units Wide

- 2** two units wide [A]
- 3** three units wide [A]

Step 3. Width

For two units wide (2)

- 60** 60" wide [A]
- 66** 66" wide [A]
- 72** 72" wide [A]
- 78** 78" wide [A]
- 84** 84" wide [A]
- 90** 90" wide [A]
- 96** 96" wide [A]

For three units wide (3)

- 72** 72" wide [A]
- 78** 78" wide [A]
- 84** 84" wide [A]
- 90** 90" wide [A]
- 96** 96" wide [A]

Step 4. Top Material

- 03** 3/8" laminate top [A]
- 04** 3/8" veneer top [A]

Prices for Steps 1-4.

		03	04
FV490. 2	60	\$320	665
	66	\$328	678
	72	\$356	689
	78	\$372	718
	84	\$389	745
	90	\$417	797
	96	\$433	853
3	72	\$356	689
	78	\$372	718
	84	\$389	745
	90	\$417	797
	96	\$433	853

Common Thin Top, Overhead Storage *continued*

Canvas Office Landscape® Storage

Step 5. Top Finish

Solid-Color Laminate

For 3/8" laminate top (03)

8Q	folkstone grey <input type="checkbox"/>	+\$0
91	white <input type="checkbox"/>	+\$0
98	studio white	+\$0
CL	cool grey neutral <input type="checkbox"/>	+\$0
LU	soft white <input type="checkbox"/>	+\$0
WL	sandstone <input type="checkbox"/>	+\$0
WN	warm grey neutral <input type="checkbox"/>	+\$0

Linen Laminate

For 3/8" laminate top (03)

LBM	crisp linen	+\$0
LBN	classic linen	+\$0
LBP	casual linen	+\$0

Mesh Laminate

For 3/8" laminate top (03)

LBK	pewter mesh	+\$0
LBL	steel mesh	+\$0

Twill Laminate

For 3/8" laminate top (03)

LBF	neutral twill	+\$0
LBG	sarum twill	+\$0
LBH	earthen twill	+\$0
LBJ	graphite twill	+\$0
LBQ	white twill	+\$0

Wood-Grain Laminate

For 3/8" laminate top (03)

HM	natural maple <input type="checkbox"/>	+\$0
HP	light anigre <input type="checkbox"/>	+\$0
LBA	clear on ash	+\$0
LBR	phantom ecru	+\$0
LBS	phantom cocoa	+\$0
LBU	medium matte walnut	+\$0
LBV	warm grey teak	+\$0
LBB	oak on ash	+\$0
LBC	walnut on ash	+\$0
LBD	dark brown walnut	+\$0
LBE	medium red walnut	+\$0
76	light brown walnut <input type="checkbox"/>	+\$0
HX	aged cherry <input type="checkbox"/>	+\$0
HY	walnut on cherry <input type="checkbox"/>	+\$0

Wood Veneer

For 3/8" veneer top (04)

2U	light brown walnut <input type="checkbox"/>	+\$85
40	dark brown walnut <input type="checkbox"/>	+\$85
ED	aged cherry <input type="checkbox"/>	+\$85
EK	medium red walnut <input type="checkbox"/>	+\$85
EW	medium matte walnut <input type="checkbox"/>	+\$85
ET	clear on ash <input type="checkbox"/>	+\$85
EU	oak on ash <input type="checkbox"/>	+\$85
EV	walnut on ash <input type="checkbox"/>	+\$85
UL	natural maple <input type="checkbox"/>	+\$85
UX	walnut on cherry <input type="checkbox"/>	+\$85

Tackboard

FV980.

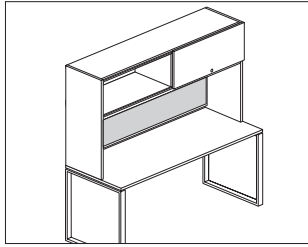

Product Information

Description

This tackboard attaches below a hutch or to an architectural wall.

Notes

For additional product options, see Vary Easy Program in Appendices.

For hutch-mount option (HM), match tackboard width to hutch width.

Vary Easy Program offers the tackboard in 15" to 30"-high in 1" increments and 24"-72"-wide in 1" increments

Tackboard accepts Customer's Own Material (COM). Yardage is estimated for directional, 54"-wide fabrics.

For hutch mounted (HM) with tackable fabric, horizontal (R)

Width—Yardage

59" , 60" —1.86

65" , 66" —2.02

71" , 72" —2.19

For wall mounted (WM) with tackable fabric (T)

Height—Yardage

12" —.58

16" —.69

23" —.88

24" —.91

30" —1.05

For wall mounted (WM) with tackable fabric, horizontal (R)

Width—Yardage

24" —.91

30" —1.08

36" —1.25

42" —1.41

48" —1.58

54" —1.75

60" —1.91

66" —2.08

72" —2.25

For information on multiple quantities or nondirectional fabrics, contact COM Department. See Order Information in Appendices.

Dimensions

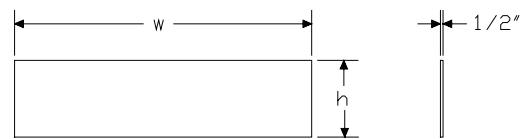

Specification Information	
Step 1.	
FV980.	
Step 2. Mount Option	
HM	hutch mounted
WM	wall mount
Step 3. Height	
<i>For hutch mounted (HM)</i>	
12	12" high
15	15" high
<i>For wall mount (WM)</i>	
12	12" high
16	16" high
23	23" high
24	24" high
29	28½" high
Step 4. Width	
<i>For hutch mounted (HM)</i>	
59	59" wide
60	60" wide
65	65" wide
66	66" wide
71	71" wide
72	72" wide
<i>For wall mount (WM)</i>	
24	24" wide
30	30" wide
36	36" wide
42	42" wide
48	48" wide
54	54" wide
60	60" wide
66	66" wide
72	72" wide

Step 5. Surface Material	
<i>For 24" wide (24), 30" wide (30), 36" wide (36), 42" wide (42), or 48" wide (48)</i>	
T	tackable fabric
R	tackable fabric, horizontal
<i>For 54" wide (54), 59" wide (59), 60" wide (60), 65" wide (65), 66" wide (66), 71" wide (71), or 72" wide (72)</i>	
R	tackable fabric, horizontal

Prices for Steps 1-5.							
		24T	24R	30T	30R	36T	36R
FV980. WM	12	\$130	130	162	162	190	190
	16	\$154	154	185	185	217	217
	23	\$275	275	308	308	337	337
	24	\$275	275	308	308	337	337
	29	\$311	311	344	344	375	375
		42T	42R	48T	48R	54R	59R
FV980. HM	12	—	—	—	—	—	\$321
	15	—	—	—	—	—	\$332
	WM 12	\$225	225	260	260	308	—
	16	\$250	250	283	283	332	—
	23	\$372	372	407	407	490	—
	24	\$372	372	407	407	490	—
	29	\$409	409	441	441	527	—
		60R	65R	66R	71R	72R	
FV980. HM	12	\$321	332	332	344	344	
	15	\$332	344	344	357	357	
	WM 12	\$321	—	332	—	344	
	16	\$344	—	357	—	368	
	23	\$502	—	516	—	527	
	24	\$502	—	516	—	527	
	29	\$539	—	552	—	563	

Step 6. Fabric

See application chart and textiles list for fabric usage and numbers.

First 2 digits of number indicate fabric line; remaining digit(s) indicate fabric color.

	12	15	16	23	24
Price Category 1	+\$0	0	0	0	0
Price Category 2	+\$19	21	21	25	25
Price Category 3	+\$33	37	37	42	42
Price Category 4	+\$51	55	55	66	66
Price Category 5	+\$103	113	113	136	136
Price Category B	+\$35	41	41	52	54
Price Category C	+\$47	56	56	72	74
Price Category D	+\$60	71	71	91	94
Price Category E	+\$72	86	86	110	114
Price Category F	+\$94	111	111	142	147
Price Category G	+\$122	145	145	184	191
				29	
Price Category 1					+\$0
Price Category 2					+\$31
Price Category 3					+\$49
Price Category 4					+\$73
Price Category 5					+\$146
Price Category B					+\$63
Price Category C					+\$86
Price Category D					+\$108
Price Category E					+\$131
Price Category F					+\$169
Price Category G					+\$220

Tackboard Cable Manager

FV985.

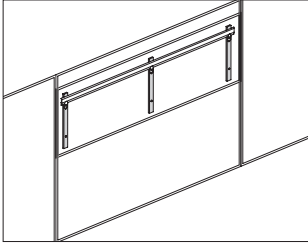

Canvas Office Landscape® Storage

Product Information

Description
 This spacer strip allows for cable management behind a tackboard used in a wall-mount application. Package contains 12. Finish is black.

Notes

Attachment hardware must be customer supplied.
 Specify spacer strip as follows:
 Tackboard size—spacer required
 12"–14" (must be field cut to accommodate 12" tackboard)
 16"–14"
 23"–21"
 24"–21"
 29"–27"
 Recommended maximum of 16" spacing between spacer strips.

Dimensions

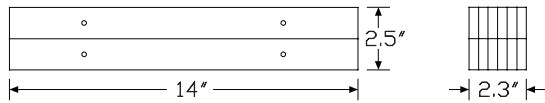

Specification Information

Step 1.

FV985. A

Step 2. Size

- 14** for use with 12" and 16" high A
- 21** for use with 23" and 24" high A
- 27** for use with 29" high A

Prices for Steps 1-2.

FV985. 14	\$133
21	\$140
27	\$150

Pencil Drawer

Y5010.

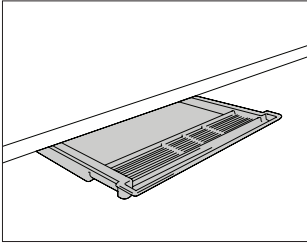

Product Information

Description

This plastic drawer mounts under a hanging or freestanding work surface to store pencils and other small items. Mounting hardware is included.

Dimensions

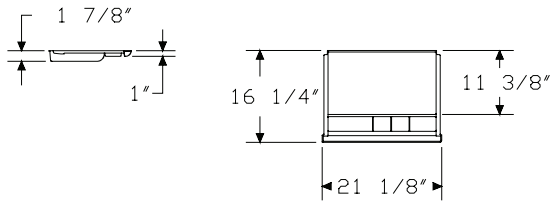

Specification Information

Step 1.

Y5010. \$49

Step 2. Surface Finish

8Q	folkstone grey	+\$0
BU	black umber	+\$0
HF	inner tone light	+\$0
LT	light tone	+\$0
LU	soft white	+\$0
MT	medium tone	+\$0
SG	slate grey	+\$0
WL	sandstone	+\$0
WN	warm grey neutral	+\$0

Canvas Office Landscape® Storage

Metal Pencil Drawer

Y5012.

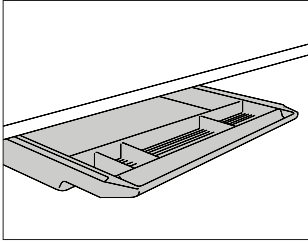

Product Information

Description

This metal drawer mounts under a hanging or freestanding work surface to store pencils and other small items. Mounting hardware is included.

Dimensions

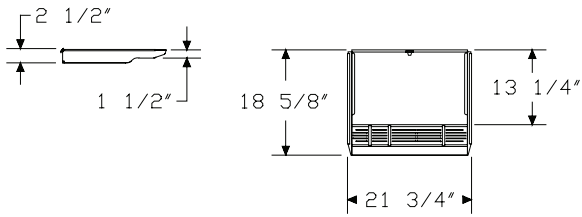

Specification Information

Step 1.

Y5012. \$215

Step 2. Surface Finish

8Q	folkstone grey	+\$0
98	studio white	+\$0
BU	black umber	+\$0
HF	inner tone light	+\$0
LT	light tone	+\$0
LU	soft white	+\$0
MT	medium tone	+\$0
SG	slate grey	+\$0
WL	sandstone	+\$0
WN	warm grey neutral	+\$0

Signature Screen, Surface-Attached

FT350.

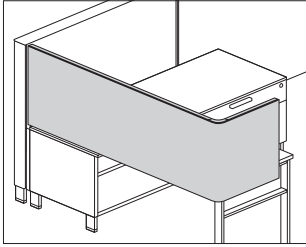

Product Information

Description

This screen attaches to a surface to provide visual privacy. It is designed to match the height of a 42"-high frame, but can be adjusted to provide varying privacy above and below the surface. The screen has an aluminum frame with a textile surface and is available in 2 heights.

Notes

When top of screen matches the height of a 42"-high frame, the 18"-high screen extends approximately 4" below the surface and the 23"-high screen extends approximately 9" below the surface.

When attached to a surface, there is a 1/2" gap between the back edge and the screen.

Dimensions

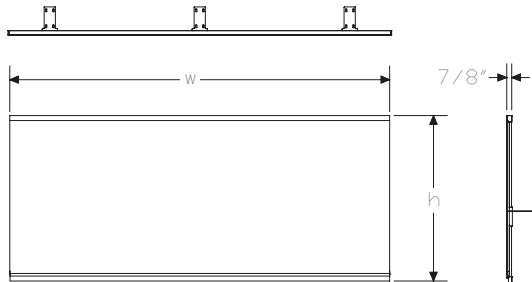

Specification Information

Step 1.

FT350.

Step 2. Attachment Type

A surface attached

Step 3. Configuration

SS straight

CC corner wrap

Step 4. Height

18 18" high

23 23" high

Step 5. Depth

For straight (SS)

NN none

For corner wrap (CC)

20 20" deep

Step 6. Width

40 39 1/2" wide

46 45 1/2" wide

52 51 1/2" wide

60 60" wide

66 66" wide

72 72" wide

Step 7. Surface Material

S woven screen

Prices for Steps 1-7.

	182040S	182046S	182052S	182060S	182066S	182072S
FT350. A CC	\$1020	1048	1072	1257	1282	1323
	18NN40S	18NN46S	18NN52S	18NN60S	18NN66S	18NN72S
FT350. A SS	\$680	712	742	943	974	1015
	232040S	232046S	232052S	232060S	232066S	232072S
FT350. A CC	\$1049	1074	1101	1292	1320	1360
	23NN40S	23NN46S	23NN52S	23NN60S	23NN66S	23NN72S
FT350. A SS	\$712	743	773	986	1017	1060

Signature Screen, Surface-Attached *continued*

Step 8. Surface Finish
*See application chart and textiles list for fabric usage and numbers.
First 2 digits of number indicate fabric line; remaining digit(s) indicate fabric color.*

Price Category 1	+\$0
------------------	------

Step 9. Frame Finish

MS metallic silver <input type="checkbox"/> A	+\$0
--	------

Canvas Office Landscape® Screens

Pari Screen, Surface Attached

FT351.

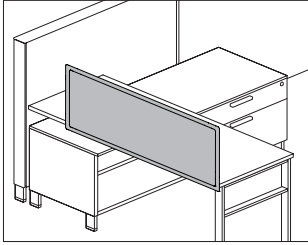

Product Information

Description

This tackable fabric screen attaches to a Canvas work surface to provide boundary with a tackable surface. Attachment hardware included.

Notes

Screen widths are actual dimensions, and extend to the end of Canvas work surfaces.

Screen extends 4" below surface to hide attachment hardware.

Screen can be flush with back edge of surface, or provide a 1" gap.

Screens 48" wide and wider include an additional 1"-wide center mounting bracket.

Screen accepts Customer's Own Material (COM). Yardage is estimated for nondirectional 54"-wide fabrics.

For vertical fabric direction (T):

Height—Yardage

42—1.49

46—1.73

53—2.18

For horizontal fabric direction (R):

Width—Yardage

40—1.34

42—1.51

46—1.62

48—1.71

52—1.81

54—1.90

60—2.07

66—2.27

72—2.46

For information on multiple quantities or directional fabrics, contact COM Department. See Order Information in Appendices.

Dimensions

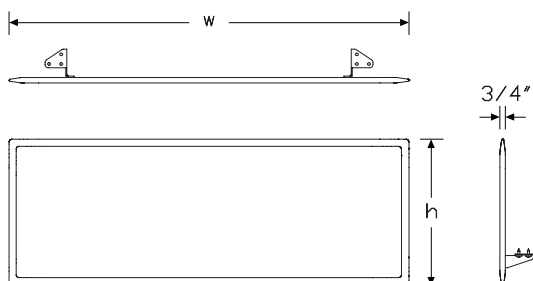

Specification Information

Step 1.

FT351. A

Step 2. Attachment

C Canvas surface attached A

Step 3. Height

42 42" high A

46 46" high A

53 53" high A

Step 4. Width

40 39 1/2" wide A

42 42" wide A

46 45 1/2" wide A

48 48" wide A

52 51 1/2" wide A

54 54" wide A

60 60" wide A

66 66" wide A

72 72" wide A

Step 5. Surface Material

For 39 1/2" wide (40), 42" wide (42), 45 1/2" wide (46), or 48" wide (48)

R tackable fabric, horizontal A

T tackable fabric A

For 51 1/2" wide (52)

R tackable fabric, horizontal A

For 54" wide (54), 60" wide (60), 66" wide (66), or 72" wide (72)

R tackable fabric, horizontal A

Prices for Steps 1-5.

		40R	40T	42R	42T	46R	46T
FT351. C	42	\$773	773	783	783	793	793
	46	\$819	819	849	849	909	909
	53	\$1010	1010	1091	1091	1137	1137
		48R	48T	52R	54R	60R	66R
FT351. C	42	\$808	808	874	894	975	1046
	46	\$955	955	1000	1046	1122	1182
	53	\$1152	1152	1202	1218	1238	1248

Pari Screen, Surface Attached

continued

	72R
FT351. C 42	\$1101
46	\$1228
53	\$1273

Step 6. Bracket Finish	
G2 graphite satin A	+\$0

Step 7. Fabric					
	40	42	46	48	52
Price Category 1	+\$0	0	0	0	0
Price Category 2	+\$23	23	23	23	27
Price Category 3	+\$54	54	54	54	65
Price Category 4	+\$94	94	94	94	113
Price Category E	+\$234	234	234	234	234
		54	60	66	72
Price Category 1	+\$0	0	0	0	0
Price Category 2	+\$27	27	33	33	33
Price Category 3	+\$65	65	78	78	78
Price Category 4	+\$113	113	135	135	135
Price Category E	+\$234	234	234	234	234

Canvas Office Landscape® Screens

Flat Edge Screen, Surface Attached

FT356.

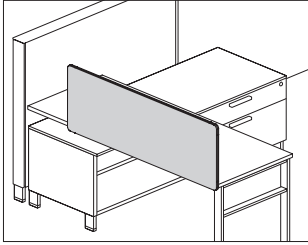

Product Information

Description

This tackable fabric screen attaches to a Canvas work surface to provide boundary with a tackable surface. Attachment hardware included.

Notes

Screen widths are actual dimensions, and extend to the end of Canvas work surfaces.

Screen extends 4" below surface to hide attachment hardware.

Screen can be flush with back edge of surface, or provide a 1" gap.

Screens 48" wide and wider include an additional 1"-wide center mounting bracket.

Screen accepts Customer's Own Material (COM). Yardage is estimated for nondirectional 54"-wide fabrics.

For vertical fabric direction (T):

Height—Yardage

42—1.49

46—1.73

53—2.18

For horizontal fabric direction (R):

Width—Yardage

40—1.34

42—1.51

46—1.62

48—1.71

52—1.81

54—1.90

60—2.07

66—2.27

72—2.46

For information on multiple quantities or directional fabrics, contact COM Department. See Order Information in Appendices.

Dimensions

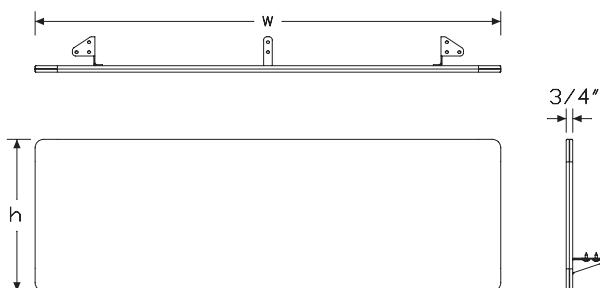

Specification Information

Step 1.

FT356.

Step 2. Attachment

C Canvas surface attached

Step 3. Height

42 42" high

46 46" high

53 53" high

Step 4. Width

40 39 1/2" wide

42 42" wide

46 45 1/2" wide

48 48" wide

52 51 1/2" wide

54 54" wide

60 60" wide

66 66" wide

72 72" wide

Step 5. Surface Material

For 39 1/2" wide (40), 42" wide (42), 45 1/2" wide (46), or 48" wide (48)

R tackable fabric, horizontal

T tackable fabric

For 51 1/2" wide (52), 54" wide (54), 60" wide (60), 66" wide (66), or 72" wide (72)

R tackable fabric, horizontal

Prices for Steps 1-5.

		40R	40T	42R	42T	46R	46T
FT356. C	42	\$601	601	612	612	639	639
	46	\$647	647	677	677	701	701
	53	\$839	839	920	920	932	932
		48R	48T	52R	54R	60R	66R
FT356. C	42	\$654	654	676	696	738	788
	46	\$747	747	771	817	884	925
	53	\$947	947	959	974	1000	1005

Flat Edge Screen, Surface
Attached *continued*

Canvas Office Landscape® Screens

	72R
FT356. C 42	\$839
46	\$965
53	\$1010

Step 6. Bracket Finish	
G2 graphite satin	+\$0

Step 7. Fabric					
	40	42	46	48	52
Price Category 1	+\$0	0	0	0	0
Price Category 2	+\$23	23	23	23	27
Price Category 3	+\$54	54	54	54	65
Price Category 4	+\$94	94	94	94	113
Price Category E	+\$169	169	169	169	169
		54	60	66	72
Price Category 1	+\$0	0	0	0	0
Price Category 2	+\$27	27	27	27	27
Price Category 3	+\$65	65	65	65	65
Price Category 4	+\$113	113	113	113	113
Price Category E	+\$169	169	169	169	169

Pari Screen, Surface Attached with Modesty

FT353.

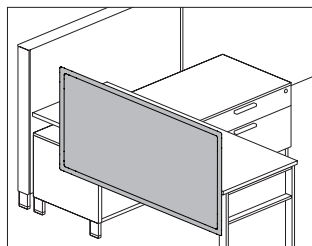

Product Information

Description

This tackable fabric screen attaches to a Canvas work surface to provide boundary and modesty with a tackable surface. An optional cable management trough is available. Trough finish is graphite. Attachment hardware included.

Notes

Screen widths are actual dimensions, and extend to the end of Canvas work surfaces.

Screen extends 9" below surface for modesty.

Screen can be flush with back edge of surface, or provide a 1" gap.

Screens 48" wide and wider include an additional 1"-wide center mounting bracket.

Screen accepts Customer's Own Material (COM). Yardage is estimated for nondirectional 54"-wide fabrics.

For vertical fabric direction (T):

Height—Yardage

42—1.90

46—2.14

53—2.59

For horizontal fabric direction (R):

Width—Yardage

40—2.87

42—3.02

46—3.22

48—3.41

52—3.63

54—3.78

60—4.17

66—4.54

72—4.92

For information on multiple quantities or directional fabrics, contact COM Department. See Order Information in Appendices.

Dimensions

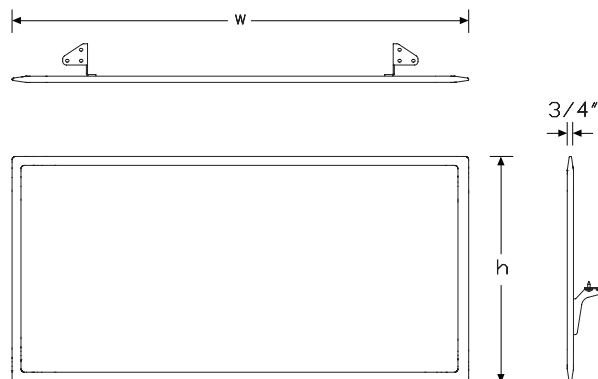

Canvas Office Landscape® Screens

Pari Screen, Surface Attached with Modesty *continued*

Specification Information

Step 1.

FT353. A

Step 2. Attachment

C Canvas surface attached A

Step 3. Height

A42 42" high/9" below surface A

A46 46" high/9" below surface A

A53 53" high/9" below surface A

Step 4. Width

40 39½" wide A

42 42" wide A

46 45½" wide A

48 48" wide A

52 51½" wide A

54 54" wide A

60 60" wide A

66 66" wide A

72 72" wide A

Step 5. Surface Material

For 39½" wide (40), 42" wide (42), 45½" wide (46), or 48" wide (48)

R tackable fabric, horizontal A

T tackable fabric A

For 51½" wide (52)

R tackable fabric, horizontal A

For 54" wide (54), 60" wide (60), 66" wide (66), or 72" wide (72)

R tackable fabric, horizontal A

Prices for Steps 1-5.

		40R	40T	42R	42T	46R	46T
FT353. C	A42	\$879	879	909	909	1000	1000
	A46	\$1010	1010	1046	1046	1111	1111
	A53	\$1162	1162	1182	1182	1258	1258
		48R	48T	52R	54R	60R	66R
FT353. C	A42	\$1010	1010	1091	1137	1162	1253
	A46	\$1147	1147	1167	1202	1273	1313
	A53	\$1273	1273	1303	1319	1364	1409

72R

FT353. C	A42	\$1288
	A46	\$1344
	A53	\$1435

Step 6. Cable Trough

NC no cable way A +\$0

CW cable way A +\$25

Step 7. Cable Trough Finish

G2 graphite satin A +\$0

Step 8. Bracket Finish

G2 graphite satin A +\$0

Step 9. Fabric

	40	42	46	48	52
Price Category 1	+\$0	0	0	0	0
Price Category 2	+\$36	36	36	36	52
Price Category 3	+\$86	86	86	86	123
Price Category 4	+\$150	150	150	150	214
Price Category E	+\$169	169	169	169	169
	54	60	66	72	
Price Category 1	+\$0	0	0	0	0
Price Category 2	+\$52	52	64	64	
Price Category 3	+\$123	123	154	154	
Price Category 4	+\$214	214	267	267	
Price Category E	+\$169	169	169	169	

Pari Screen, Delineation

FT354.

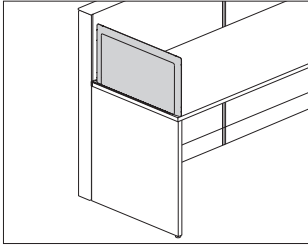

Product Information

Description

This tackable fabric screen attaches to a work surface either at the seam or at the right or left edge to provide division and boundary between workers. It attaches with no interference from supports below the work surface. Attachment hardware included.

Notes

Screen height is 13¹/₂" or 17¹/₂" above work surface, aligning with bead heights of 41" and 45".

Screen width matches work surface depths that have a 1" gap at the back edge.

2 attachment methods ship with the end-of-run right handed (CR) and end-of-run left handed (CL) screen. The screen can be installed using the bracket, or using threaded screws that drill bayonets directly into the surface. See planning guide for exact location of holes.

End-of-run screen does not work on Canvas Beam.

See planning guide for applications and other compatible product lines.

Screen accepts Customer's Own Material (COM). Yardage is estimated for nondirectional 54"-wide fabrics.

For vertical fabric direction (T):

Height—Yardage

42—1.19

46—1.45

For horizontal fabric direction (R):

Width—Yardage

24—0.90

30—1.10

36—1.30

For information on multiple quantities or directional fabrics, contact COM Department. See Order Information in Appendices.

Dimensions

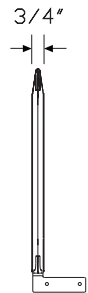
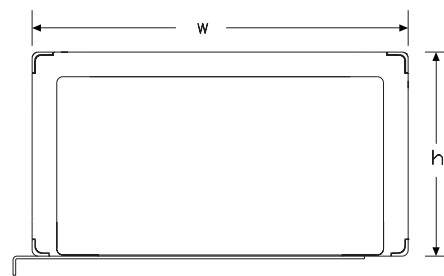

Specification Information

Step 1.

FT354. A

Step 2. Attachment Type

CL Canvas Surface Attached, End of Run Left Handed A

CR Canvas Surface Attached, End of Run Right Handed A

Step 3. Height

42 42" high A

46 46" high A

Step 4. Width

24 24" wide A

30 30" wide A

36 36" wide A

Step 5. Surface Material

R tackable fabric, horizontal A

T tackable fabric A

Prices for Steps 1-5.

	24R	24T	30R	30T	36R	36T
FT354. CL 42	\$849	849	879	879	904	904
46	\$894	894	930	930	965	965
CR 42	\$849	849	879	879	904	904
46	\$894	894	930	930	965	965

Step 6. Bracket Finish

8Q folkstone grey A +\$0

91 white A +\$0

98 studio white A +\$0

G1 graphite A +\$0

WL sandstone A +\$0

WN warm grey neutral A +\$0

Step 7. Fabric

Price Category 1 +\$0

Price Category 2 +\$17

Price Category 3 +\$40

Price Category 4 +\$70

Price Category E +\$169

Pari Screen, Storage Attached

FV360.

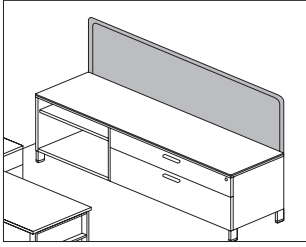

Product Information

Description

This tackable fabric screen attaches to a Canvas low credenza using the thin top and provides boundary with a tackable surface. Attachment hardware included.

Notes

Order credenza thin top separately:

- Credenza top for wood credenza (FF889.)
- Credenza top for metal credenza (FM889.)

Pre-drilled holes near back edge of credenza thin top allow for bayonets to extend up to support the screen.

Works with standard and powered Canvas credenzas.

Screen accepts Customer's Own Material (COM). Yardage is estimated for nondirectional 54"-wide fabrics.

For vertical fabric direction (T):

Height—Yardage

- 24—0.95
- 30—1.14
- 36—1.32

For horizontal fabric direction (R), for 42" high:

Width—Yardage

- 24—0.95
- 30—1.14
- 36—1.32
- 42—1.51
- 48—1.71
- 60—2.07
- 66—2.27
- 72—2.46

For horizontal fabric direction (R), for 46" high and 53" high:

Width—Yardage

- 24—1.90
- 30—2.27
- 36—2.66
- 42—3.02
- 48—3.41
- 60—4.17
- 66—4.54
- 72—4.92

For information on multiple quantities or directional fabrics, contact COM Department. See Order Information in Appendices.

Dimensions

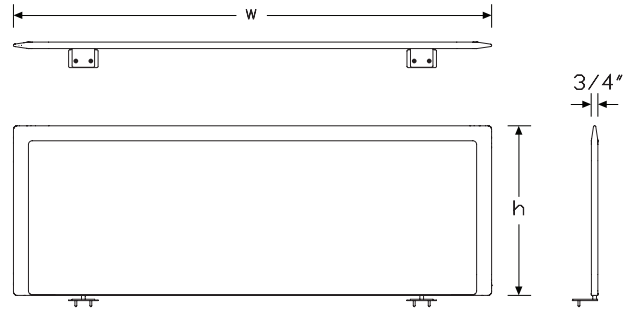

Pari Screen, Storage Attached

continued

Canvas Office Landscape® Screens

Specification Information

Step 1.

FV360. A

Step 2. Attachment

CS Canvas credenza attached, single A

CB Canvas credenza attached, back to back A

Step 3. Height

42 42" high A

46 46" high A

53 53" high A

Step 4. Width

30 30" wide A

36 36" wide A

42 42" wide A

48 48" wide A

60 60" wide A

66 66" wide A

72 72" wide A

Step 5. Surface Material

For 30" wide (30), 36" wide (36), 42" wide (42), or 48" wide (48)

R tackable fabric, horizontal A

T tackable fabric A

For 60" wide (60), 66" wide (66), or 72" wide (72)

R tackable fabric, horizontal A

Prices for Steps 1-5.

	30R	30T	36R	36T	42R	42T
FV360. CS 42	\$735	735	765	765	810	810
46	\$765	765	855	855	900	900
53	\$900	900	945	945	1095	1095
CB 42	\$735	735	765	765	810	810
46	\$765	765	855	855	900	900
53	\$900	900	945	945	1095	1095
	48R	48T	60R	66R	72R	
FV360. CS 42	\$945	945	1080	1100	1125	
46	\$990	990	1125	1190	1215	
53	\$1170	1170	1305	1370	1395	
CB 42	\$945	945	1080	1100	1125	
46	\$990	990	1125	1190	1215	
53	\$1170	1170	1305	1370	1395	

Step 6. Fabric

For 30" wide (30), 36" wide (36), or 42" wide (42)

Price Category 1 +\$0

Price Category 2 +\$38

Price Category 3 +\$90

Price Category 4 +\$156

Price Category E +\$325

For 48" wide (48) or 60" wide (60)

Price Category 1 +\$0

Price Category 2 +\$31

Price Category 3 +\$74

Price Category 4 +\$127

Price Category E +\$325

For 66" wide (66) or 72" wide (72)

Price Category E +\$325

Price Category 1 +\$0

Price Category 2 +\$38

Price Category 3 +\$90

Price Category 4 +\$156

Flat Edge Screen, Storage Attached

FV361.

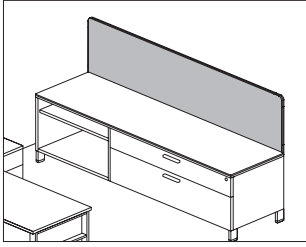

Product Information

Description

This tackable fabric screen attaches to a Canvas low credenza using the thin top and provides boundary with a tackable surface. Attachment hardware included.

Notes

Order credenza thin top separately:

- Credenza top for wood credenza (FF889.)
- Credenza top for metal credenza (FM889.)

Predrilled holes near back edge of credenza thin top allow for bayonets to extend up to support the screen.

Works with standard and powered Canvas credenzas.

Screen accepts Customer's Own Material (COM). Yardage is estimated for nondirectional 54"-wide fabrics.

For vertical fabric direction (T):

Height—Yardage

24—0.95

30—1.14

36—1.32

For horizontal fabric direction (R), for 42" high:

Width—Yardage

24—0.95

30—1.14

36—1.32

42—1.51

48—1.71

60—2.07

66—2.27

72—2.46

For horizontal fabric direction (R), for 46" high and 53" high:

Width—Yardage

24—1.90

30—2.27

36—2.66

42—3.02

48—3.41

60—4.17

66—4.54

72—4.92

For information on multiple quantities or directional fabrics, contact COM Department. See Order Information in Appendices.

Dimensions

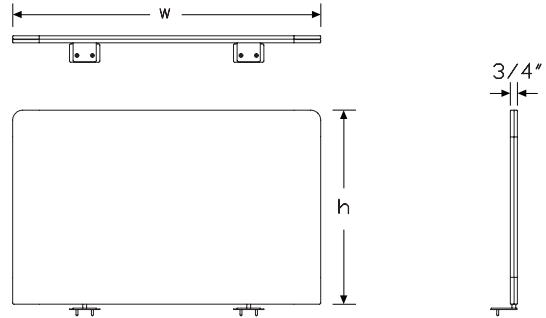

Flat Edge Screen, Storage Attached *continued*

Specification Information

Step 1.

FV361.

Step 2. Attachment

CB Canvas credenza attached, back to back

CS Canvas credenza attached, single

Step 3. Height

42 42" high

46 46" high

53 53" high

Step 4. Width

30 30" wide

36 36" wide

42 42" wide

48 48" wide

60 60" wide

66 66" wide

72 72" wide

Step 5. Surface Material

For 30" wide (30), 36" wide (36), 42" wide (42), or 48" wide (48)

R tackable fabric, horizontal

T tackable fabric

For 60" wide (60), 66" wide (66), or 72" wide (72)

R tackable fabric, horizontal

Prices for Steps 1-5.

	30R	30T	36R	36T	42R	42T	
FV361. CB 42	\$670	670	724	724	778	778	
46	\$700	700	814	814	868	868	
53	\$835	835	904	904	1063	1063	
CS 42	\$670	670	724	724	778	778	
46	\$700	700	814	814	868	868	
53	\$835	835	904	904	1063	1063	
			48R	48T	60R	66R	72R
FV361. CB 42		\$832	832	885	940	995	
46		\$877	877	930	1030	1085	
53		\$1085	1085	1110	1210	1265	
CS 42		\$832	832	885	940	995	
46		\$877	877	930	1030	1085	
53		\$1085	1085	1110	1210	1265	

Step 6. Fabric

	30	36	42	48	60
Price Category 1	+\$0	0	0	0	0
Price Category 2	+\$38	38	38	38	31
Price Category 3	+\$90	90	90	90	74
Price Category 4	+\$156	156	156	156	127
Price Category E	+\$0	0	0	0	0
				66	72
Price Category 1				+\$0	0
Price Category 2				+\$31	31
Price Category 3				+\$74	74
Price Category 4				+\$127	127
Price Category E				+\$0	0

Screen

FV694.

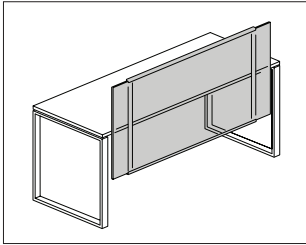

Product Information

Description

This screen attaches to a desk or return. It has a 1"-thick frame with a 1/4"-thick translucent or painted surface. Attachment hardware included.

Notes

When attaching the 12"-high screen to a basic desk or return, specify screen width 6" less than surface width.

When attaching a screen of any height to a single pedestal desk or pedestal return, specify screen width 18" less than surface width. When attaching to a double pedestal desk, specify screen width 30" less than surface width.

When attached to surface, there is a 1 1/2" gap between the back edge and the screen.

For translucent plastic (A) surface material, screen frame finish is metallic silver (MS). For painted (P) surface material, screen frame finish will match bracket finish (Step 6.).

For cable management between screen and back edge of surface, specify cable manager (FV695.) separately.

Dimensions

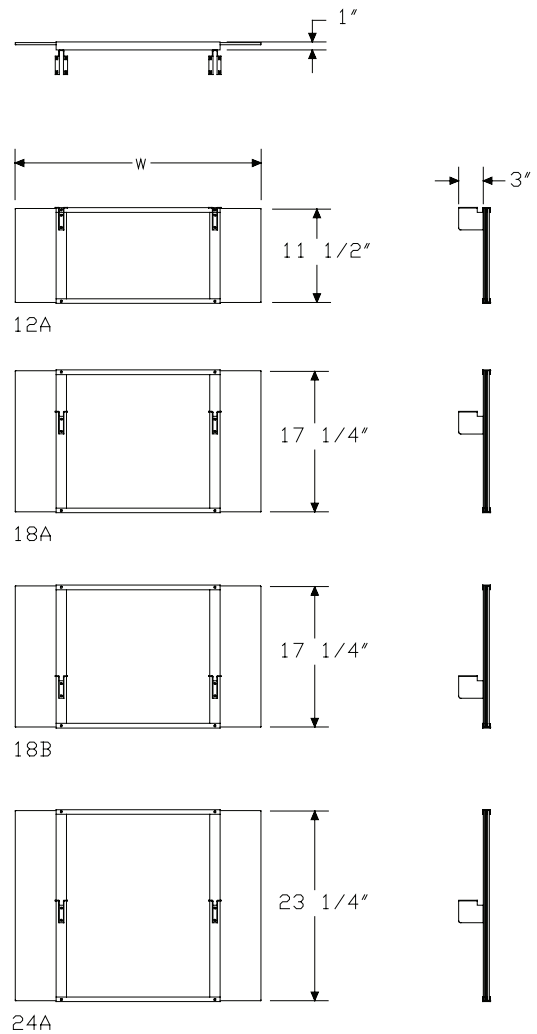

Specification Information

Step 1.

FV694.

Step 2. Surface Material

- A** translucent plastic
- P** painted

Step 3. Height

For painted (P)

12A 12" below work surface

For translucent plastic (A)

12A 12" below work surface

18A 6" above/12" below work surface

18B 12" above/6" below work surface

24A 12" above/12" below work surface

Step 4. Width

For 12" below work surface (12A)

30 30" wide

36 36" wide

42 42" wide

48 48" wide

54 54" wide

60 60" wide

66 66" wide

72 72" wide

For 6" above/12" below work surface (18A), 12" above/6" below work surface (18B), or 12" above/12" below work surface (24A)

30 30" wide

36 36" wide

42 42" wide

48 48" wide

54 54" wide

Prices for Steps 1-4.

		30	36	42	48	54	60
FV694. A	12A	\$692	721	748	775	803	831
	18A	\$728	758	786	816	843	—
	18B	\$728	758	786	816	843	—
	24A	\$831	865	898	931	964	—
	P 12A	\$630	654	679	705	730	755

66 72

FV694. A	12A	\$859	885
	P 12A	\$781	804

Step 5. Surface Finish

Sand Texture Paint

For painted (P)

8Q folkstone grey +\$0

98 studio white +\$0

WL sandstone +\$0

Bright Sand Texture Paint

For painted (P)

91 white +\$0

CL cool grey neutral +\$0

G1 graphite +\$0

WN warm grey neutral +\$0

Metallic Paint

For painted (P)

CN metallic champagne +\$0

EH metallic bronze +\$0

MS metallic silver +\$0

Translucent Plastic

For translucent plastic (A)

J9 opal frosted +\$0

Step 6. Bracket Finish

Bright Sand Texture Paint

91 white +\$0

CL cool grey neutral +\$0

G1 graphite +\$0

WN warm grey neutral +\$0

8Q folkstone grey +\$0

98 studio white +\$0

WL sandstone +\$0

Metallic Paint

CN metallic champagne +\$0

EH metallic bronze +\$0

MS metallic silver +\$0

Privacy Panel

FV693.

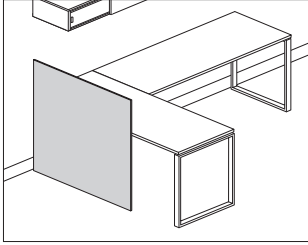

Product Information

Description

This panel stands on the floor and attaches to a desk or return to provide partial- or full-width privacy. It is $\frac{3}{4}$ " thick, has a laminate or veneer surface, and includes leveling glides. Attachment hardware included.

Notes

For additional product options, see Vary Easy Program in Appendices.

Grain direction is vertical on veneer and wood-grain laminate panel.

29"-high panel provides modesty from the floor to the surface. 42"- and 46"-high panels rise above the surface for visual privacy.

When attached to surface, there is a $1\frac{1}{2}$ " gap between the back edge and the panel.

Wood-grain laminate option is only available in 33" - 60" widths. Specify 2 panels to match the width of surfaces wider than 60".

For cable management between privacy panel and back edge of surface, specify cable manager (FV695.) separately.

Dimensions

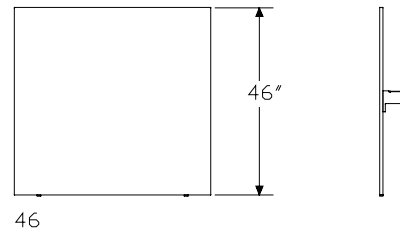
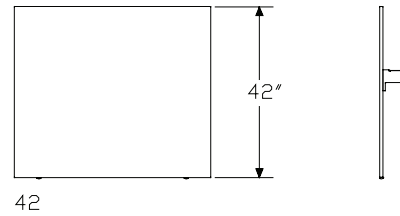
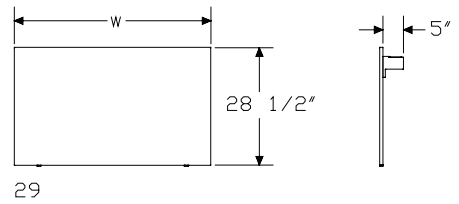
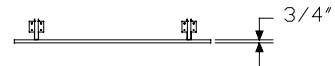

Specification Information

Step 1.
FV693.

Step 2. Height

29	29" high
42	42" high
46	46" high

Step 3. Width

For 29" high (29)

33	33" wide
36	36" wide
48	48" wide
54	54" wide
60	60" wide
66	66" wide
72	72" wide
84	84" wide

For 42" high (42) or 46" high (46)

48	48" wide
54	54" wide
60	60" wide
72	72" wide

Step 4. Surface Material

L	laminate
W	veneer <input type="checkbox"/> A

Prices for Steps 1-4.

	L	W
FV693. 29 33	\$278	607
36	\$303	662
48	\$401	882
54	\$452	990
60	\$502	1102
66	\$552	1207
72	\$602	1322
84	\$701	1541
42 48	\$487	1164
54	\$547	1308
60	\$607	1457
72	\$728	1749

46 48	\$509	1218
54	\$575	1375
60	\$638	1525
72	\$765	1829

Step 5. Surface Finish

Solid-Color Laminate

For 33" wide (33), 36" wide (36), 48" wide (48), 54" wide (54), 60" wide (60), 66" wide (66), 72" wide (72), or 84" wide (84) with laminate (L)

8Q	folkstone grey	+\$0
91	white	+\$0
98	studio white	+\$0
CL	cool grey neutral	+\$0
LU	soft white	+\$0
WL	sandstone	+\$0
WN	warm grey neutral	+\$0

Linen Laminate

For 33" wide (33), 36" wide (36), 48" wide (48), 54" wide (54), or 60" wide (60) with laminate (L)

LBM	crisp linen	+\$0
LBN	classic linen	+\$0
LBP	casual linen	+\$0

Mesh Laminate

For 33" wide (33), 36" wide (36), 48" wide (48), 54" wide (54), or 60" wide (60) with laminate (L)

LBK	pewter mesh	+\$0
LBL	steel mesh	+\$0

Twill Laminate

For 33" wide (33), 36" wide (36), 48" wide (48), 54" wide (54), or 60" wide (60) with laminate (L)

LBF	neutral twill	+\$0
LBG	sarum twill	+\$0
LBH	earthen twill	+\$0
LBJ	graphite twill	+\$0
LBQ	white twill	+\$0

Privacy Panel *continued*

Wood-Grain Laminate

For 33" wide (33), 36" wide (36), 48" wide (48), 54" wide (54), or 60" wide (60) with laminate (L)

76	light brown walnut	+\$0
HM	natural maple	+\$0
HP	light anigre	+\$0
HX	aged cherry	+\$0
HY	walnut on cherry	+\$0
LBA	clear on ash	+\$0
LBR	phantom ecru	+\$0
LBS	phantom cocoa	+\$0
LBU	medium matte walnut	+\$0
LBV	warm grey teak	+\$0
LBB	oak on ash	+\$0
LBC	walnut on ash	+\$0
LBD	dark brown walnut	+\$0
LBE	medium red walnut	+\$0

Wood Veneer

For veneer (W)

2U	light brown walnut A	+\$85
40	dark brown walnut	+\$85
ED	aged cherry A	+\$85
EK	medium red walnut	+\$85
EW	medium matte walnut	+\$85
ET	clear on ash A	+\$85
EU	oak on ash A	+\$85
EV	walnut on ash A	+\$85
UL	natural maple A	+\$85
UX	walnut on cherry	+\$85

Step 6. Support Finish

Bright Sand Texture Paint

8Q	folkstone grey	+\$0
91	white	+\$0
98	studio white	+\$0
CL	cool grey neutral	+\$0
G1	graphite	+\$0
WL	sandstone	+\$0
WN	warm grey neutral	+\$0

Metallic Paint

CN	metallic champagne	+\$0
EH	metallic bronze	+\$0
MS	metallic silver	+\$0

Modesty Panel

FV697.

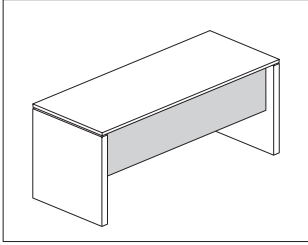

Canvas Office Landscape® Screens

Product Information

Description
 This modesty panel attaches to a closed-leg rectangular or concave rectangular desk to provide partial- or full-height enclosure below the surface and increase stability. The panel can be mounted inset from the back edge of the desk, or flush with the back edge for knee clearance. Available in laminate or veneer. Attachment hardware included.

Notes
 Modesty panel spans between 2 closed support legs (FV2E2.24, .30, or .36) and attaches to the closed support legs and underside of a surface. It does not work with shared closed support legs.
 Grain direction is vertical on veneer and wood-grain laminate panel.
 Wood-grain laminate option is only available in 36" - 60" widths.

Dimensions

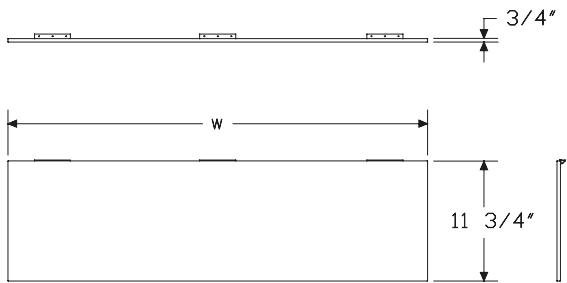

Half Modesty Panel

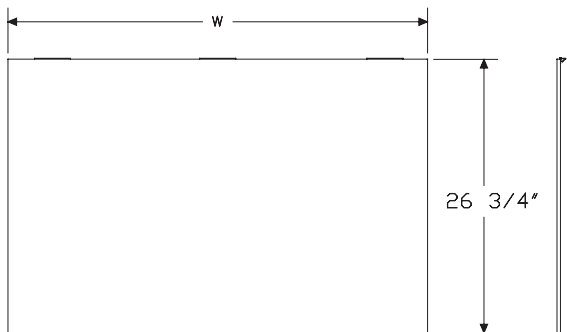

Full Modesty Panel

Specification Information

Step 1.
FV697.

Step 2. Width

60	60" wide
66	66" wide
72	72" wide
84	84" wide
96	96" wide

Step 3. Modesty Panel Type

F	full modesty panel
H	half modesty panel

Step 4. Surface Material

L	laminate
W	veneer <input type="checkbox"/> A

Prices for Steps 1-4.

	L	W
FV697. 60 F	\$502	1102
H	\$352	618
66 F	\$552	1207
H	\$386	686
72 F	\$602	1322
H	\$419	752
84 F	\$701	1541
H	\$433	886
96 F	\$804	1767
H	\$446	1024

Step 5. Surface Finish

Solid-Color Laminate
 For 60" wide (60), 66" wide (66), 72" wide (72), 84" wide (84), or 96" wide (96) with laminate (L)

8Q	folkstone grey	+\$0
91	white	+\$0
98	studio white	+\$0
CL	cool grey neutral	+\$0
LU	soft white	+\$0
WL	sandstone	+\$0
WN	warm grey neutral	+\$0

Modesty Panel *continued*

Linen Laminate

For 60" wide (60) with laminate (L)

LBM	crisp linen	+\$0
LBN	classic linen	+\$0
LBP	casual linen	+\$0

Mesh Laminate

For 60" wide (60) with laminate (L)

LBK	pewter mesh	+\$0
LBL	steel mesh	+\$0

Twill Laminate

For 60" wide (60) with laminate (L)

LBF	neutral twill	+\$0
LBG	sarum twill	+\$0
LBH	earthen twill	+\$0
LBJ	graphite twill	+\$0
LBQ	white twill	+\$0

Wood-Grain Laminate

For 60" wide (60) with laminate (L)

76	light brown walnut	+\$0
HM	natural maple	+\$0
HP	light anigre	+\$0
HX	aged cherry	+\$0
HY	walnut on cherry	+\$0
LBA	clear on ash	+\$0
LBR	phantom ecru	+\$0
LBS	phantom cocoa	+\$0
LBU	medium matte walnut	+\$0
LBV	warm grey teak	+\$0
LBB	oak on ash	+\$0
LBC	walnut on ash	+\$0
LBD	dark brown walnut	+\$0
LBE	medium red walnut	+\$0

Wood Veneer

For veneer (W)

2U	light brown walnut A	+\$50
40	dark brown walnut	+\$50
ED	aged cherry A	+\$50
EK	medium red walnut	+\$50
EW	medium matte walnut	+\$50
ET	clear on ash A	+\$50
EU	oak on ash A	+\$50
EV	walnut on ash A	+\$50
UL	natural maple A	+\$50
UX	walnut on cherry	+\$50

Flat Edge Screen, Surface
Attached with Modesty

FT357.

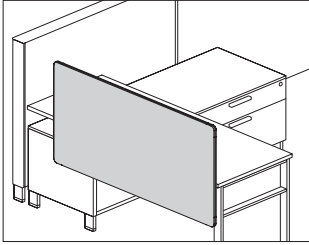

Product Information

Description

This tackable fabric screen attaches to a Canvas work surface to provide boundary and modesty with a tackable surface. An optional cable management trough is available. Trough finish is graphite. Attachment hardware included.

Notes

Screen widths are actual dimensions, and extend to the end of Canvas work surfaces.

Screen extends 9" below surface for modesty.

Screen can be flush with back edge of surface, or provide a 1" gap.

Screens 48" wide and wider include an additional 1"-wide center mounting bracket.

Screen accepts Customer's Own Material (COM). Yardage is estimated for nondirectional 54"-wide fabrics.

For vertical fabric direction (T):

Height—Yardage

42—1.90

46—2.14

53—2.59

For horizontal fabric direction (R):

Width—Yardage

40—2.87

42—3.02

46—3.22

48—3.41

52—3.63

54—3.78

60—4.17

66—4.54

72—4.92

For information on multiple quantities or directional fabrics, contact COM Department. See Order Information in Appendices.

Dimensions

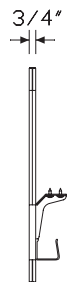
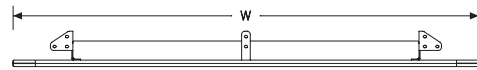

Flat Edge Screen, Surface

Attached with Modesty *continued*

Specification Information

Step 1.

FT357.

Step 2. Attachment

C Canvas surface attached

Step 3. Height

A42 42" high/9" below surface

A46 46" high/ 9" below surface

A53 53" high/ 9" below surface

Step 4. Width

40 39½" wide

42 42" wide

46 45½" wide

48 48" wide

52 51½" wide

54 54" wide

60 60" wide

66 66" wide

72 72" wide

Step 5. Surface Material

For 39½" wide (40), 42" wide (42), 45½" wide (46), or 48" wide (48)

R tackable fabric, horizontal

T tackable fabric

For 51½" wide (52), 54" wide (54), 60" wide (60), 66" wide (66), or 72" wide (72)

R tackable fabric, horizontal

Prices for Steps 1-5.

		40R	40T	42R	42T	46R	46T
FT357. C	A42	\$647	647	677	677	704	704
	A46	\$778	778	814	814	817	817
	A53	\$930	930	950	950	955	955

		48R	48T	52R	54R	60R	66R
FT357. C	A42	\$715	715	733	752	788	849
	A46	\$842	842	854	870	899	933
	A53	\$963	963	969	976	990	1024

		72R
FT357. C	A42	\$909
	A46	\$965
	A53	\$1056

Step 6. Cable Trough

NC no cable way +\$0

CW cable way +\$25

Step 7. Cable Trough Finish

G2 graphite satin +\$0

Step 8. Bracket Finish

G2 graphite satin +\$0

Step 9. Fabric

	40	42	46	48	52
Price Category 1	+\$0	0	0	0	0
Price Category 2	+\$36	36	36	36	52
Price Category 3	+\$86	86	86	86	123
Price Category 4	+\$150	150	150	150	214
Price Category E	+\$169	169	169	169	169
	54	60	66	72	
Price Category 1	+\$0	0	0	0	
Price Category 2	+\$52	52	52	52	
Price Category 3	+\$123	123	123	123	
Price Category 4	+\$214	214	214	214	
Price Category E	+\$169	169	169	169	

Flat Edge Screen, Delineation

FT358.

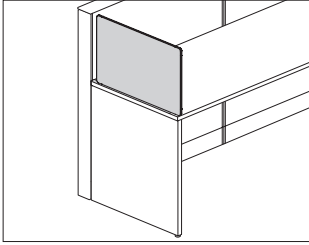

Product Information

Description

This tackable fabric screen attaches to a work surface at the right or left edge to provide division and boundary between workers. It attaches with no interference from supports below the work surface. Attachment hardware included.

Notes

Screen height is 13¹/₂" or 17¹/₂" above work surface, aligning with bead heights of 41" and 45".

Screen width matches work surface depths that have a 1" gap at the back edge.

2 attachment methods ship with the end-of-run right handed (CR) and end-of-run left handed (CL) screen. The screen can be installed using the bracket, or using threaded screws that drill bayonets directly into the surface. See planning guide for exact location of holes.

End-of-run screen does not work on Canvas Beam.

See planning guide for applications and other compatible product lines.

Screen accepts Customer's Own Material (COM). Yardage is estimated for nondirectional 54"-wide fabrics.

For vertical fabric direction (T):

Height—Yardage

42—1.19

46—1.45

For horizontal fabric direction (R):

Width—Yardage

24—0.90

30—1.10

36—1.30

For information on multiple quantities or directional fabrics, contact COM Department. See Order Information in Appendices.

Dimensions

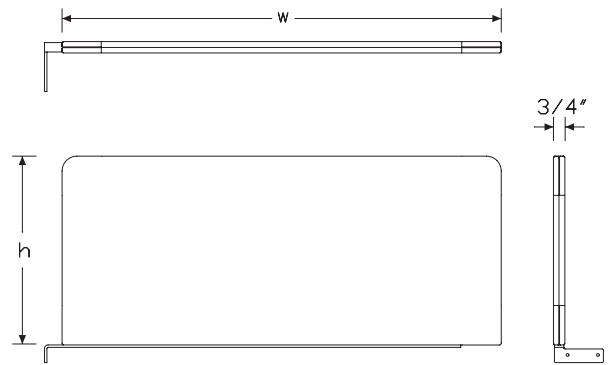

Flat Edge Screen, Delineation

continued

Specification Information

Step 1.

FT358.

Step 2. Attachment Type

CL Canvas Surface Attached, End of Run Left Handed

CR Canvas Surface Attached, End of Run Right Handed

Step 3. Height

42 42" high

46 46" high

Step 4. Width

24 24" wide

30 30" wide

36 36" wide

Step 5. Surface Material

R tackable fabric, horizontal

T tackable fabric

Prices for Steps 1-5.

	24R	24T	30R	30T	36R	36T
FT358. CL 42	\$526	526	556	556	566	566
46	\$571	571	606	606	627	627
CR 42	\$526	526	556	556	566	566
46	\$571	571	606	606	627	627

Step 6. Bracket Finish

8Q folkstone grey +\$0

91 white +\$0

98 studio white +\$0

G1 graphite +\$0

WL sandstone +\$0

WN warm grey neutral +\$0

Step 7. Fabric

Price Category 1 +\$0

Price Category 2 +\$17

Price Category 3 +\$40

Price Category 4 +\$70

Price Category E +\$169

Flat Edge Screen, Frame Top

FT359.

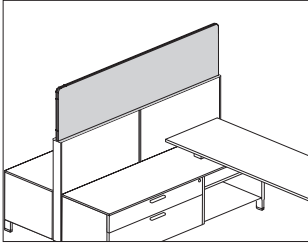

Product Information

Description

This tackable fabric screen attaches to the top of a Canvas frame (or frames) to provide boundary with a tackable surface. Bayonets extend through the top cap for attachment, which allows the screen to sit cleanly on the top cap. Frame top cap and attachment hardware included.

Notes

Specify width of screen to match the width of 1 frame, or the combined width of 2 frames.

24"- to 48"-wide frame top screens can only span 1 frame. 54"-wide and wider can span 2 frames.

Screen comes with metal alignment piece that attaches into the top of 2 screens to align them along a run.

15"-high screen will align with top of upmount unit (FT415.), but not with other frame top screens.

Cables cannot be routed along top channel of frame where screen is attached.

Screen cannot attach to top of thin-profile stacking window (FT187.)

Screen cannot be used in in-line, frame-to-frame, change-of-height applications.

Screen cannot be used on frames with veneer finished ends.

Screen cannot be used next to connector-attached power poles (FT143., FT14A.).

A frame with a flat edge screen, frame top (FT359.) cannot be placed off module to a spine wall frame.

Options (F) and (G) are for 54"-wide and wider top cap to span the combined width of 2 adjacent frames placed between 2 universal connectors or a universal connector and a finished end.

Options (H) and (I) are for 54"-wide and wider top cap to span the combined width of 2 adjacent frames in runs of 3 frames or more.

Order screen attached marker board (FD125.) separately.

Screen accepts Customer's Own Material (COM). Yardage is estimated for nondirectional 54"-wide fabrics.

For vertical fabric direction (T):

Height—Yardage

11—1.04

15—1.30

For horizontal fabric direction (R):

Width—Yardage

24—0.95

30—1.14

36—1.32

42—1.51

48—1.71

54—1.90

60—2.07

66—2.27

72—2.46

For information on multiple quantities or directional fabrics, contact COM Department. See Order Information in Appendices.

Dimensions

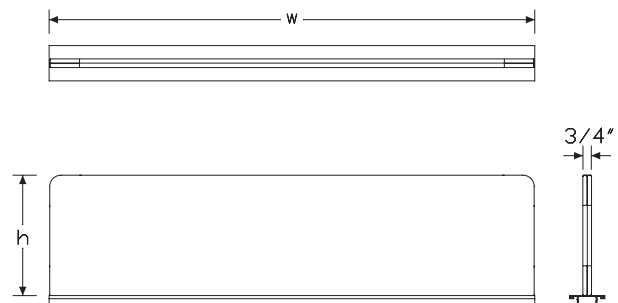

Flat Edge Screen, Frame Top

continued

Specification Information

Step 1.

FT359.

Step 2. Height

11 11" high
15 15" high

Step 3. Width

24 24" wide
30 30" wide
36 36" wide
42 42" wide
48 48" wide
54 54" wide
60 60" wide
66 66" wide
72 72" wide

Step 4. Surface Material

For 24" wide (24), 30" wide (30), 36" wide (36), 42" wide (42), or 48" wide (48)

R tackable fabric, horizontal
T tackable fabric

For 54" wide (54), 60" wide (60), 66" wide (66), or 72" wide (72)

R tackable fabric, horizontal

Step 5. Top Cap Material

For 24" wide (24), 30" wide (30), 36" wide (36), 42" wide (42), or 48" wide (48)

A painted architectural top cap
P painted standard top cap

For 54" wide (54), 60" wide (60), 66" wide (66), or 72" wide (72)

F painted extended architectural top cap to span 2 frames
G painted extended standard top cap to span 2 frames
H painted extended architectural top cap to span 2 frames in runs of 3 frames or more
J painted extended standard top cap to span 2 frames in runs of 3 frames or more

Prices for Steps 1-5.

	RA	RF	RG	RH	RJ	RP
FT359. 11 24	\$550	—	—	—	—	515
30	\$595	—	—	—	—	553
36	\$640	—	—	—	—	591
42	\$685	—	—	—	—	629
48	\$730	—	—	—	—	667
54	—	\$775	705	775	705	—
60	—	\$820	745	820	745	—
66	—	\$885	808	885	808	—
72	—	\$950	870	950	870	—
15 24	\$565	—	—	—	—	530
30	\$615	—	—	—	—	573
36	\$675	—	—	—	—	626
42	\$730	—	—	—	—	674
48	\$775	—	—	—	—	707
54	—	\$815	745	815	745	—
60	—	\$875	805	875	805	—
66	—	\$970	893	970	893	—
72	—	\$1070	990	1070	990	—

	TA	TP
FT359. 11 24	\$550	515
30	\$595	553
36	\$640	591
42	\$685	629
48	\$730	667
15 24	\$565	530
30	\$615	573
36	\$675	626
42	\$730	674
48	\$775	707

Step 6. Top Cap Finish

91	white	+\$0
CL	cool grey neutral	+\$0
CN	metallic champagne	+\$0
EH	metallic bronze	+\$0
G1	graphite	+\$0
MS	metallic silver	+\$0
WN	warm grey neutral	+\$0

Flat Edge Screen, Frame Top

continued

Canvas Office Landscape® Screens

Step 7. Fabric					
	24	30	36	42	48
Price Category 1	+\$0	0	0	0	0
Price Category 2	+\$15	15	15	15	15
Price Category 3	+\$35	35	35	35	35
Price Category 4	+\$61	61	61	61	61
Price Category E	+\$99	99	99	99	99
		54	60	66	72
Price Category 1	+\$0	0	0	0	0
Price Category 2	+\$25	25	25	25	25
Price Category 3	+\$60	60	60	60	60
Price Category 4	+\$104	104	104	104	104
Price Category E	+\$99	99	99	99	99

Laminate Screen, Surface Attached

FT360.

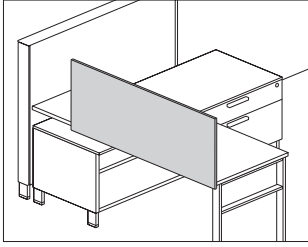

Product Information

Description

This laminate screen attaches to a Canvas work surface to provide boundary. Attachment hardware included.

Notes

Screen widths are actual dimensions; screens extend to the ends of Canvas work surfaces.

Screen extends 4" below surface to hide attachment hardware.

Screen can be flush with back edge of surface, or provide a 1" gap.

Screens 48" wide and wider include an additional 1"-wide center mounting bracket.

Dimensions

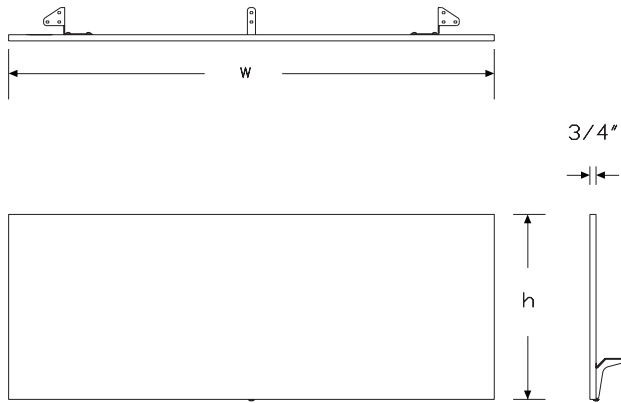

Specification Information

Step 1.

FT360.

Step 2. Attachment

C Canvas surface attached

Step 3. Height

42 42" high

46 46" high

Step 4. Width

39A 39 1/2" wide

42 42" wide

45A 45 1/2" wide

48 48" wide

51A 51 1/2" wide

54 54" wide

60 60" wide

66 66" wide

72 72" wide

Step 5. Surface Material

L laminate

U laminate/universal edge

Prices for Steps 1-5.

		39AL	39AU	42L	42U	45AL	45AU
FT360. C	42	\$360	360	369	369	378	378
	46	\$445	445	454	454	463	463
		48L	48U	51AL	51AU	54L	54U
FT360. C	42	\$388	388	397	397	406	406
	46	\$473	473	482	482	491	491
		60L	60U	66L	66U	72L	72U
FT360. C	42	\$415	415	438	438	460	460
	46	\$500	500	523	523	545	545

Step 6. Grain Direction

For 39 1/2" wide (39A), 42" wide (42), 45 1/2" wide (45A), 48" wide (48), 51 1/2" wide (51A), 54" wide (54), or 60" wide (60)

VTG	vertical grain	+\$0
HRG	horizontal grain	+\$0

Laminate Screen, Surface Attached *continued*

For 66" wide (66) or 72" wide (72)

HRG horizontal grain +\$0

Step 7. Bracket Finish

G2 graphite satin +\$0

Step 8. Surface Finish

76	light brown walnut	+\$0
8Q	folkstone grey	+\$0
91	white	+\$0
98	studio white	+\$0
CL	cool grey neutral	+\$0
HM	natural maple	+\$0
HP	light anigre	+\$0
HX	aged cherry	+\$0
HY	walnut on cherry	+\$0
LA	light ash	+\$0
LBA	clear on ash	+\$0
LBB	oak on ash	+\$0
LBC	walnut on ash	+\$0
LBD	dark brown walnut	+\$0
LBE	medium red walnut	+\$0
LBF	neutral twill	+\$0
LBG	sarum twill	+\$0
LBH	earthen twill	+\$0
LBJ	graphite twill	+\$0
LBK	pewter mesh	+\$0
LBL	steel mesh	+\$0
LBM	crisp linen	+\$0
LBN	classic linen	+\$0
LBP	casual linen	+\$0
LBQ	white twill	+\$0
LBR	phantom ecru	+\$0
LBS	phantom cocoa	+\$0
LBU	medium matte walnut	+\$0
LBV	warm grey teak	+\$0
LU	soft white	+\$0
WL	sandstone	+\$0
WN	warm grey neutral	+\$0

Step 9. Edge Finish

For laminate (L)

76	light brown walnut	+\$0
8Q	folkstone grey	+\$0
91	white	+\$0
98	studio white	+\$0

BU	black umber	+\$0
CL	cool grey neutral	+\$0
HF	inner tone light	+\$0
HM	natural maple	+\$0
HP	light anigre	+\$0
HX	aged cherry	+\$0
HY	walnut on cherry	+\$0
LA	light ash	+\$0
LBA	clear on ash	+\$0
LBR	phantom ecru	+\$0
LBS	phantom cocoa	+\$0
LBU	medium matte walnut	+\$0
LBV	warm grey teak	+\$0
LBB	oak on ash	+\$0
LBC	walnut on ash	+\$0
LBD	dark brown walnut	+\$0
LBE	medium red walnut	+\$0
LBF	neutral twill	+\$0
LBG	sarum twill	+\$0
LBH	earthen twill	+\$0
LBJ	graphite twill	+\$0
LBK	pewter mesh	+\$0
LBL	steel mesh	+\$0
LBM	crisp linen	+\$0
LBN	classic linen	+\$0
LBP	casual linen	+\$0
LBQ	white twill	+\$0
LU	soft white	+\$0
MT	medium tone	+\$0
WL	sandstone	+\$0
WN	warm grey neutral	+\$0

For laminate/universal edge (U)

PLY plywood edge +\$50

Laminate Screen, Surface Attached with Modesty

FT361.

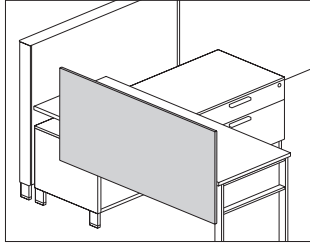

Product Information

Description

This laminate screen attaches to a Canvas work surface to provide boundary and modesty. An optional cable management trough is available. Trough finish is graphite. Attachment hardware included.

Notes

Screen widths are actual dimensions; screens extend to the ends of Canvas work surfaces.

Screen extends 9" below surface for modesty.

Screen can be flush with back edge of surface, or provide a 1" gap.

Screens 48" wide and wider include an additional 1"-wide center mounting bracket.

Dimensions

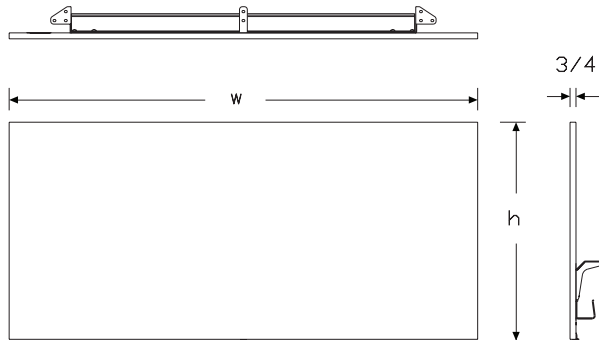

Specification Information

Step 1.

FT361.

Step 2. Attachment

C Canvas surface attached

Step 3. Height

A42 42" high/9" below surface

A46 46" high/9" below surface

Step 4. Width

39A 39 1/2" wide

42 42" wide

45A 45 1/2" wide

48 48" wide

51A 51 1/2" wide

54 54" wide

60 60" wide

66 66" wide

72 72" wide

Step 5. Surface Material

L laminate

U laminate/universal edge

Prices for Steps 1-5.

		39AL	39AU	42L	42U	45AL	45AU
FT361. C	A42	\$390	390	400	400	410	410
	A46	\$483	483	493	493	503	503
		48L	48U	51AL	51AU	54L	54U
FT361. C	A42	\$420	420	430	430	440	440
	A46	\$513	513	523	523	533	533
		60L	60U	66L	66U	72L	72U
FT361. C	A42	\$450	450	470	470	490	490
	A46	\$543	543	563	563	583	583

Step 6. Grain Direction

For 39 1/2" wide (39A), 42" wide (42), 45 1/2" wide (45A), 48" wide (48), 51 1/2" wide (51A), 54" wide (54), or 60" wide (60)

VTG	vertical grain	+\$0
HRG	horizontal grain	+\$0

Laminate Screen, Surface Attached with Modesty *continued*

For 66" wide (66) or 72" wide (72)

HRG horizontal grain +\$0

Step 7. Cable Way

CW cable way +\$25
NC no cable way +\$0

Step 8. Cable Way Finish
For cable way (CW)

G2 graphite satin +\$0

Step 9. Bracket Finish

G2 graphite satin +\$0

Step 10. Surface Finish

76 light brown walnut +\$0
8Q folkstone grey +\$0
91 white +\$0
98 studio white +\$0
CL cool grey neutral +\$0
HM natural maple +\$0
HP light anigre +\$0
HX aged cherry +\$0
HY walnut on cherry +\$0
LA light ash +\$0
LBA clear on ash +\$0
LBB oak on ash +\$0
LBC walnut on ash +\$0
LBD dark brown walnut +\$0
LBE medium red walnut +\$0
LBF neutral twill +\$0
LBG sarum twill +\$0
LBH earthen twill +\$0
LBJ graphite twill +\$0
LBK pewter mesh +\$0
LBL steel mesh +\$0
LBM crisp linen +\$0
LBN classic linen +\$0
LBP casual linen +\$0
LBQ white twill +\$0
LBR phantom ecru +\$0
LBS phantom cocoa +\$0
LBU medium matte walnut +\$0
LBV warm grey teak +\$0
LU soft white +\$0
WL sandstone +\$0
WN warm grey neutral +\$0

Step 11. Edge Finish

For laminate (L)

76 light brown walnut +\$0
8Q folkstone grey +\$0
91 white +\$0
98 studio white +\$0
BU black umber +\$0
CL cool grey neutral +\$0
HF inner tone light +\$0
HM natural maple +\$0
HP light anigre +\$0
HX aged cherry +\$0
HY walnut on cherry +\$0
LA light ash +\$0
LBA clear on ash +\$0
LBR phantom ecru +\$0
LBS phantom cocoa +\$0
LBU medium matte walnut +\$0
LBV warm grey teak +\$0
LBB oak on ash +\$0
LBC walnut on ash +\$0
LBD dark brown walnut +\$0
LBE medium red walnut +\$0
LBF neutral twill +\$0
LBG sarum twill +\$0
LBH earthen twill +\$0
LBJ graphite twill +\$0
LBK pewter mesh +\$0
LBL steel mesh +\$0
LBM crisp linen +\$0
LBN classic linen +\$0
LBP casual linen +\$0
LBQ white twill +\$0
LU soft white +\$0
MT medium tone +\$0
WL sandstone +\$0
WN warm grey neutral +\$0

For laminate/universal edge (U)

PLY plywood edge +\$50

Energy-Efficient Task Light

G6120.
G6121.
G6123.

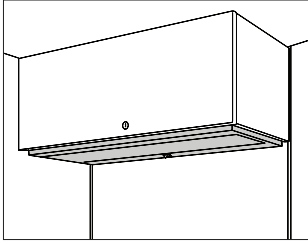

Product Information

Description

This light mounts under a metal flipper door unit, metal sliding door storage unit, or metal shelf to uniformly light a work surface. It has an instant-start electronic ballast, T8 lamp with a 3500° Kelvin color temperature, and batwing lens. The light is UL listed and CSA certified. Mounting hardware and 3 cord management clips are included.

The 24"-wide light includes 1 preheat fluorescent lamp; 30"- to 60"-wide lights include 1 rapid-start fluorescent lamp.

The task light has the following unit widths:

Task Light Width — Unit Width

- 24" — 20.77"
- 30" — 26.77"
- 36" — 32.77"
- 42" — 38.77"
- 48" — 44.77"
- 60" — 56.77"

Notes

For light used with Ethospace® utility shelf (E3234.) or C-style storage (X3750. and X3730.), specify bracket option (Q).

When specifying energy-efficient task lights for use on Passage® corner flipper door units (PJ110. and PJ111.) or corner shelves (PJ510.), specify light width as follows:

Task Light Width — Corner Flipper Unit or Shelf Width

- 36" or less — 41" or 42"
- 42" or less — 47" or 48"
- 48" or less — 53", 54", 59", or 60"
- 60" or less — 65", 66", 71", 72", 77", or 78"

Dimensions

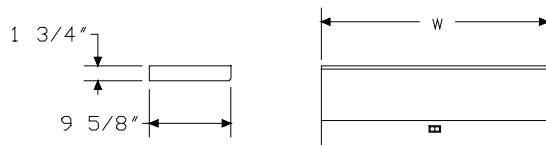

Specification Information

Step 1.

G612

Step 2. Code Requirements

- 0. meets local codes including Canada
- 1. meets Chicago codes
- 3. meets New York City codes

Step 3. Width

- 24 24" wide
- 30 30" wide
- 36 36" wide
- 42 42" wide
- 48 48" wide
- 60 60" wide

Step 4. Dimmer

For 24" wide (24)

- N no dimmer

For 30" wide (30), 36" wide (36), 42" wide (42), 48" wide (48), or 60" wide (60)

- N no dimmer
- D 3-step dimmer

Step 5. Bracket Option

- S for Action Office® or Ethospace® Systems or Canvas
- Q for C-style storage or E3234.
- P for Passage® Desking System

Prices for Steps 1-5.

	S	Q	P
G6120. 24 N	\$333	333	333
30 N	\$345	345	345
D	\$379	379	379
36 N	\$354	354	354
D	\$389	389	389
42 N	\$370	370	370
D	\$404	404	404
48 N	\$377	377	377
D	\$414	414	414
60 N	\$411	411	411
D	\$454	454	454

Energy-Efficient Task Light *continued*

Canvas Office Landscape® Lighting

	S	Q	P
G6121. 24 N	\$382	382	382
30 N	\$400	400	400
D	\$435	435	435
36 N	\$407	407	407
D	\$450	450	450
42 N	\$420	420	420
D	\$462	462	462
48 N	\$428	428	428
D	\$469	469	469
60 N	\$467	467	467
D	\$514	514	514
	S	Q	P
G6123. 24 N	\$330	330	330
30 N	\$358	358	358
D	\$396	396	396
36 N	\$368	368	368
D	\$403	403	403
42 N	\$377	377	377
D	\$414	414	414
48 N	\$388	388	388
D	\$426	426	426
60 N	\$426	426	426
D	\$467	467	467

Step 6. Surface Finish

For Action Office® or Ethospace® Systems or Canvas (S) or C-style storage or E3234. (Q)

8Q	folkstone grey	+\$0
91	white	+\$0
98	studio white <input type="checkbox"/> A	+\$0
BU	black umber	+\$0
CL	cool grey neutral	+\$0
CN	metallic champagne	+\$0
G1	graphite	+\$0
EH	metallic bronze	+\$0
HF	inner tone light	+\$0
LT	light tone	+\$0
LU	soft white	+\$0
MS	metallic silver	+\$0
MT	medium tone	+\$0
SG	slate grey	+\$0
WL	sandstone	+\$0
WN	warm grey neutral	+\$0

For Passage® Desking System (P)

BU	black umber	+\$0
-----------	-------------	------

Cast LED Light

FV617.

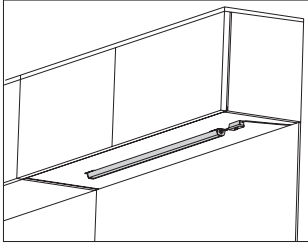

Product Information

Description

This light mounts under a Canvas overhead storage unit to provide uniform light to the work surface below. LEDs consume 8 watts of power. Cord length is 11'. Hardware is included for attachment to a wood or metal overhead storage unit.

Notes

Light widths are 18" or 30". Placement is 6" from back of storage unit.

Cord and switch can be placed on left or right side of light.

Available in 4 different kits:

Each kit includes 1 or 2 lights, 1 power supply, 2 cable management clips, and wood mounting brackets. Kits with 2 lights also include a connector that joins the 2 lights together under 1 storage unit that is 60"-96" wide or under 2 equal-width storage units that have a combined width of 60"-96".

Specify the following kit types:

- Type (2) for use with 24"-47"W storage units: (1) 18"W light.
- Type (3) for use with 48"-59"W storage units: (1) 30"W light.
- Type (4) for use with 60"-77"W storage units: (2) 18"W lights.
- Type (5) for use with 78"-96"W storage units: (2) 30"W lights.

Dimensions

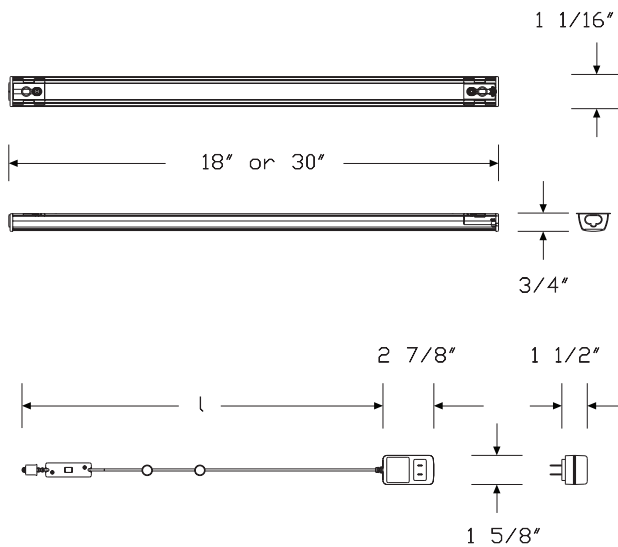

Specification Information

Step 1.

FV617. [A]

Step 2. Type

- 2N** use with 24", 30", 36", 42" wide overhead [A]
- 3N** use with 48", 54" wide overhead [A]
- 4N** use with 60", 66", 72" wide overhead or span of 2 equal width overheads [A]
- 5N** use with 78", 84", 90", 96" wide span of 2 equal width overheads [A]

Prices for Steps 1-2.

FV617. 2N	\$300
3N	\$330
4N	\$600
5N	\$660

Performance Task Light

G6114.
G6115.
G6116.
G6117.

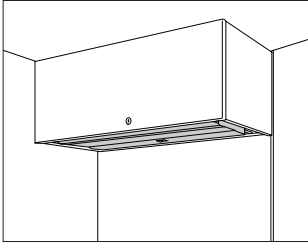

Product Information

Description

This light mounts under a flipper door unit, sliding door storage unit, shelf, transaction surface, or Corian® counter top to light the work area. It has a normal-power-factor electronic ballast or a high-power-factor electronic ballast, T5 lamp with a 3500° Kelvin color temperature, and a K-25 batwing lens. All lights are UL listed for USA and Canada. Mounting hardware and 3 cord management clips are included.

The 60"-wide light can be specified only with a 60"-wide flipper door unit or shelf; smaller lights cannot mount under 60"-wide storage products.

The task light has the following widths:

Width—Actual Width—Application

24"—13"—24"-wide storage

30"—24"—30"- or 36"-wide storage

42"—35"—42"- or 48"-wide storage

60"—46"—60"-wide storage

The daisy-chain system allows a run of lights to be operated from a single power source. A series of add-on lights is plugged into 1 starter light to operate up to 10 lights from a single outlet; each light has an independent on/off switch.

The daisy-chain add-on lights have the following cord lengths:

Light Width—Cord Length

24", 30", and 42"—42"

60"—78"

Notes

24"-wide light has a T5 lamp with a 4100° Kelvin color temperature.

For 5000 Series product applications, order cable manager (part # UMLo2F) separately.

Dimensions

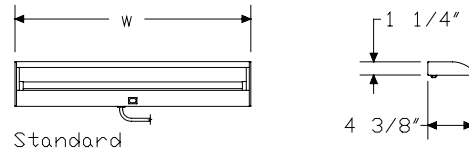

Standard

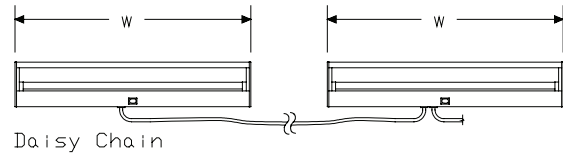

Daisy Chain

Performance Task Light *continued*

Specification Information	
Step 1.	
G611	
Step 2. Type/Code Requirements	
4.	standard and meets local codes including Canada and New York City
5.	standard and meets Chicago codes
6.	daisy chain starter and meets local codes including Canada
7.	daisy chain add-on and meets local codes including Canada
Step 3. Width	
24	24" wide
30	30" wide
42	42" wide
60	60" wide
Step 4. Ballast	
<i>For 24" wide (24)</i>	
E	normal-power-factor ballast
<i>For 30" wide (30), 42" wide (42), or 60" wide (60)</i>	
E	normal-power-factor ballast
H	high-power-factor ballast
Step 5. Dimmer	
N	no dimmer
Step 6. Attachment Bracket	
<i>For standard and meets local codes including Canada and New York City (4.) or standard and meets Chicago codes (5.)</i>	
S	for Action Office® or Ethospace® Systems or Canvas
Q	for C-style storage or E3234.
P	for Passage® Desking System
F	for 5000 Series Furniture
T	for transaction surface/counter top/wood cabinets
<i>For daisy chain starter and meets local codes including Canada (6.) or daisy chain add-on and meets local codes including Canada (7.)</i>	
S	for Action Office® or Ethospace® Systems or Canvas
Q	for C-style storage or E3234.
P	for Passage® Desking System
F	for 5000 Series Furniture

Prices for Steps 1-6.					
	NS	NQ	NP	NF	NT
G6114. 24 E	\$337	337	337	337	337
30 E	\$350	350	350	350	350
H	\$502	502	502	502	502
42 E	\$377	377	377	377	377
H	\$540	540	540	540	540
60 E	\$419	419	419	419	419
H	\$590	590	590	590	590
G6115. 24 E	\$388	388	388	388	388
30 E	\$404	404	404	404	404
H	\$565	565	565	565	565
42 E	\$425	425	425	425	425
H	\$613	613	613	613	613
60 E	\$472	472	472	472	472
H	\$660	660	660	660	660
G6116. 24 E	\$498	498	498	498	—
30 E	\$524	524	524	524	—
H	\$676	676	676	676	—
42 E	\$572	572	572	572	—
H	\$716	716	716	716	—
60 E	\$615	615	615	615	—
H	\$765	765	765	765	—
G6117. 24 E	\$448	448	448	448	—
30 E	\$462	462	462	462	—
H	\$635	635	635	635	—
42 E	\$508	508	508	508	—
H	\$659	659	659	659	—
60 E	\$553	553	553	553	—
H	\$721	721	721	721	—

Performance Task Light *continued*

Step 7. Surface Finish

8Q	folkstone grey	+\$0
91	white	+\$0
98	studio white	+\$0
BU	black umber	+\$0
CL	cool grey neutral	+\$0
CN	metallic champagne	+\$0
EH	metallic bronze	+\$0
G1	graphite	+\$0
HF	inner tone light	+\$0
LT	light tone	+\$0
LU	soft white	+\$0
MS	metallic silver	+\$0
MT	medium tone	+\$0
SG	slate grey	+\$0
WL	sandstone	+\$0
WN	warm grey neutral	+\$0

Cast LED Task Light, Valance

FV618.

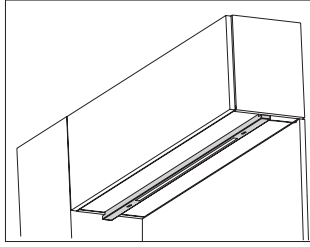

Product Information

Description

This metal valance mounts under a Canvas wood overhead storage unit and pairs with the Cast LED Light to provide uniform light to the work surface below. It comes in widths of 24" to 72". Hardware is included for attachment to wood overhead storage units.

Notes

Specify valance to match width of individual wood overhead storage.

Valance matches overhead storage width exactly and aligns to the outside of cabinet end panels.

Placement is 6" from back of storage unit.

Valance is nonhanded.

Valance includes wire management.

For use with Canvas wood overhead storage (FV43C., FV43F., FV43H., FV43P., FV43S.) only.

Dimensions

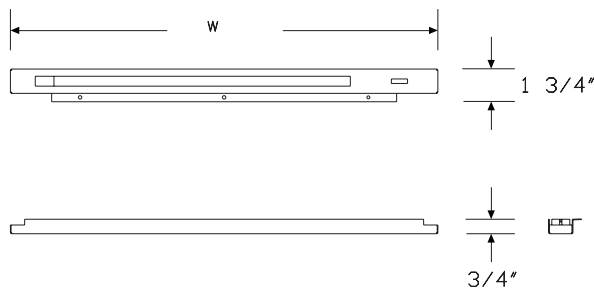

Specification Information

Step 1.

FV618. A

Step 2. Width

24	24" wide unit	<input type="checkbox"/> A
30	30" wide unit	<input type="checkbox"/> A
36	36" wide unit	<input type="checkbox"/> A
42	42" wide unit	<input type="checkbox"/> A
48	48" wide unit	<input type="checkbox"/> A
54	54" wide unit	<input type="checkbox"/> A
60	60" wide unit	<input type="checkbox"/> A
66	66" wide unit	<input type="checkbox"/> A
72	72" wide unit	<input type="checkbox"/> A

Prices for Steps 1-2.

FV618. 24	\$420
30	\$425
36	\$430
42	\$435
48	\$440
54	\$520
60	\$525
66	\$770
72	\$775

Step 3. Valance Finish

8Q	folkstone grey	<input type="checkbox"/> A	+\$0
91	white	<input type="checkbox"/> A	+\$0
98	studio white	<input type="checkbox"/> A	+\$0
CL	cool grey neutral	<input type="checkbox"/> A	+\$0
CN	metallic champagne	<input type="checkbox"/> A	+\$0
EH	metallic bronze	<input type="checkbox"/> A	+\$0
G1	graphite	<input type="checkbox"/> A	+\$0
MS	metallic silver	<input type="checkbox"/> A	+\$0
WL	sandstone	<input type="checkbox"/> A	+\$0
WN	warm grey neutral	<input type="checkbox"/> A	+\$0

Utility Task Light

G6136.
G6137.

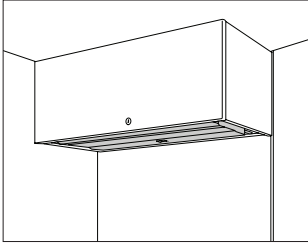

Product Information

Description

This light mounts under a flipper door unit, sliding door storage unit, shelf, transaction surface, or Corian® counter top to light the work area. It has a normal-power-factor electronic ballast, T5 lamp with a 3500° Kelvin color temperature, and prismatic lens. All lights are UL listed for USA and Canada. Mounting hardware and 3 cord management clips are included. Finish is black.

The 60"-wide light can be specified only with a 60"-wide flipper door unit or shelf; smaller lights cannot mount under 60"-wide storage products.

The task light has the following unit widths:

Width—Actual Width—Application

24"—13"—24"-wide storage

30"—24"—30"- or 36"-wide storage

42"—35"—42"- or 48"-wide storage

60"—46"—60"-wide storage

Notes

24"-wide light has a T5 lamp with a 4100° Kelvin color temperature.

For 5000 Series product applications, order cable manager (part # UMLo2F) separately.

Dimensions

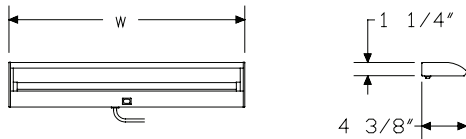

Specification Information

Step 1.

G613

Step 2. Code Requirements

- 6. meets local codes including Canada and New York City
- 7. meets Chicago codes

Step 3. Width

- 24 24" wide
- 30 30" wide
- 42 42" wide
- 60 60" wide

Step 4. Attachment Bracket

- S** for Action Office® or Ethospace® Systems or Canvas
- Q** for C-style storage or E3234.
- P** for Passage® Desking System
- F** for 5000 Series Furniture
- T** for transaction surface/counter top/wood cabinets

Prices for Steps 1-4.

	S	Q	P	F	T
G6136. 24	\$246	246	246	246	246
30	\$250	250	250	250	250
42	\$274	274	274	274	274
60	\$305	305	305	305	305
G6137. 24	\$330	330	330	330	330
30	\$334	334	334	334	334
42	\$358	358	358	358	358
60	\$392	392	392	392	392

Cable Management Clips

FT198.

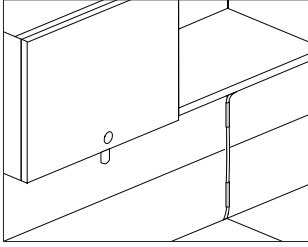

Product Information

Description

These clips attach to a frame at an in-line connection, corner, or end of a frame run (90° and 120° applications) to vertically manage task light cables. At least 2 clips are recommended to manage cables from 1 task light to below a surface. Finish is black.

Notes

Clips are available in a package of 12 or 36.

Dimensions

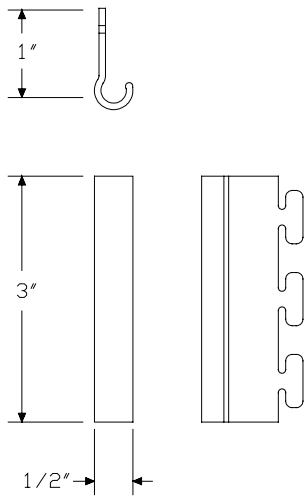

Specification Information

Step 1.

FT198.

Step 2. Quantity

12 12 clips

36 36 clips

Prices for Steps 1-2.

FT198. 12

\$53

36

\$144

Twist™ LED Task Light

G6160.

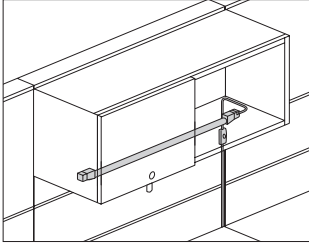

Product Information

Description

This light mounts under a flipper door unit, storage unit, shelf or any other surface to light the work area. It has an aluminum extruded housing, poly-carbonate lens, and 2 linear light-emitting diodes (LED). The light can be rotated 45 degrees forward and backward by the user to direct light where desired. The LEDs consume 9.5 watts of power. The light has an 11' cord and is UL listed, UL Canada listed, and CSA certified. Attachment hardware and adhesive cord clips included.

Notes

Specify magnetic attachment option (M) for attaching the light to any metal surface. Specify bracket attachment option (B) for attaching the light to a wood or wood composite surface.

Starter unit (B) is designed for use as a daisy chain with up to 3 add-on units (C).

Multiple lights can be specified for use under 48"- and 60"-wide storage units/shelves.

Light meets local codes for Canada, New York City, and Chicago.

Dimensions

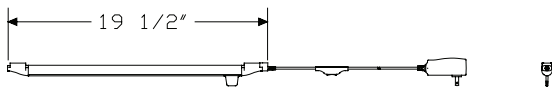

Specification Information

Step 1.

G6160.

Step 2. Type

- A** single unit
- B** starter unit
- C** add-on unit

Step 3. Attachment Method

- M** magnet attachment
- B** bracket attachment

Prices for Steps 1-3.

	M	B
G6160. A	\$421	421
B	\$507	507
C	\$365	365

Flute™ Personal Light

Y6470.

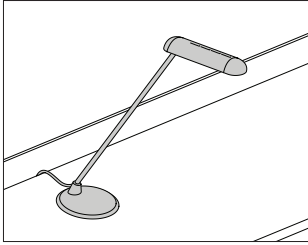

Product Information

Description

This light sits freestanding or clamps to a surface. It has 1 energy-efficient light-emitting diode (LED) with a 3500 Kelvin color temperature that consumes 4.7 watts of power. The light has an 11' cord. UL listed and UL Canada listed.

Light head swivels 230°. Clamp mount option (CM) swivels 360° at the base.

Notes

Light meets local codes including Canada, New York City, and Chicago.

Dimensions

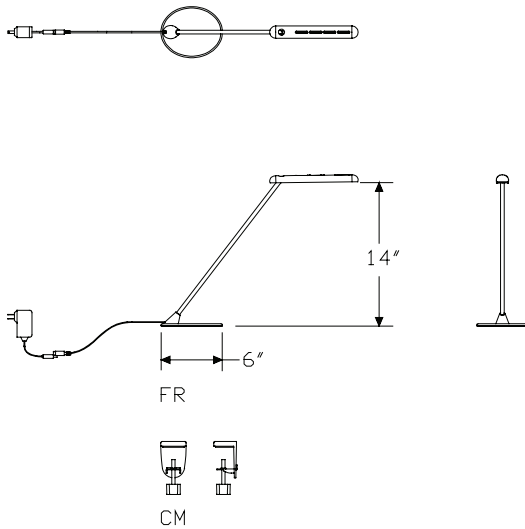

Specification Information

Step 1.

Y6470.

Step 2. Attachment Bracket

CM surface clamp

FR freestanding

Prices for Steps 1-2.

Y6470. CM	\$329
FR	\$329

Step 3. Finish

91 white	+\$0
G2 graphite satin	+\$0
MS metallic silver	+\$0

Index by Product Name

Canvas Office Landscape® Wall and Private Office	
	page(s)
90° Connector Cover	44
90° Connector Cover, Architectural	46
90° Connector Top Cap	66
90° Connector Top Cap, Architectural	68
90° Universal Connector	37
90° Universal Stacking Connector	42
120° Connector Cover	48
120° Connector Top Cap	69
120° Corner Surface, 90° Ends	224
120° Corner Surface, 120° Ends	227
120° Corner Surface, Extended 90° Ends	230
120° Universal Connector	38
120° Universal Stacking Connector	43
About Face™ Bridge Surface	280
Acoustical Insert	171
Architectural Foot	13
Base Cover Retrofit Kit	32
Base Power Harness	79
Bookcase Surface Support	294
Bowtie Rectangular Surface	186
B-Style Flipper Door Back Panel	377
B-Style Flipper Door Unit	363
B-Style Shelf	366
Cable Management Channel	326
Cable Management Clips	463, 104
Cable Management Trough	325
Cable Manager	324
Cable Tray	100
Canvas Cabinet/Wall Attachment Bracket	316
Canvas Vertical Tower Attachment Bracket	317
Cast LED Light	457
Cast LED Task Light, Valance	461
Ceiling Power Entry, Architectural Trim, Connector	93
Ceiling Power Entry, Connector	92
Ceiling Power Entry, End of Run	90
Closed Support Leg	314
Coat Hook	156
Coat Hook - Frame Attached	157
Common Thin Top, Overhead Storage	415
Communication Faceplate Extender	105
Communication Port Faceplate Extender	103
Communication Port Faceplate Reducer	101
Component Brace	388
Concave Corner Surface	208
Concave Rectangular Surface	183
Connector Base Filler	50

Controlled Receptacle, 4-Circuit, 20 Amp	97
Controlled Receptacle, 15 Amp (package of 6)	95
Controlled Receptacle Decal (12 per sheet)	98
Cord Cleat	327
Cord Manager	390
Corner Surface	205
Corner Surface with Input Platform Cutout	211
C-Style Flipper Door	381
C-Style Flipper Door Back Panel	385
C-Style Flipper Door Unit	379
C-Style Shelf	383
Curvilinear Surface	189
D-Shaped Surface	277
Dual USB Charging Module, 2 Amp	99
Energy-Efficient Task Light	455
E-Style Flipper Door Back Panel	386
E-Style Flipper Door Unit	368
E-Style Shelf	370
Extended Corner Surface, Rectangular End	213
Extended Corner Surface, Round End	219
Extended-Width Full Height Tile	111
Extended-Width Lower Power/Data Tile	135
Extended-Width Lower Power/Data Tile, Low Credenza Height	140
Extended-Width Lower Tile	123
Extended-Width Upper Tile	147
Finished End	51
Finished End, Architectural	53
Finished End, Architectural, Change-Of-Height	57
Finished End, Architectural, Privacy Door	64
Finished End, Change of Height	55
Finished End, for use with Gallery Panel	58
Fixed Surface Support, Low Credenza, Power Chase	320
Flat Edge Screen, Delineation	446
Flat Edge Screen, Frame Top	448
Flat Edge Screen, Storage Attached	435
Flat Edge Screen, Surface Attached	427
Flat Edge Screen, Surface Attached with Modesty	444
Floating Shelf, Aluminum	371
Flute™ Personal Light	465
Frame	5
Frame Grommet	102
Frame-to-Frame Connection Hardware	36
Frame Top Cap	60
Frame Top Cap, Architectural	62
Frame Top Cap, Architectural, Privacy Door	65
Frame Top Screen	24
F-Style Shelf	340

Index by Product Name *continued*

F-Style Sliding Door Storage Unit	335	Pari Screen, Frame Top	27
F-Style Storage Unit Back Panel	341	Pari Screen, Storage Attached	433
F-Style Upmount Sliding Door Storage Unit	338	Pari Screen, Surface Attached	425
Full-Height Tile	108	Pari Screen, Surface Attached with Modesty	429
Full-Height Tile, Architectural	106	Pencil Drawer	421
Full-Height Tile, Architectural with Power and Data	174	Peninsula Support Bracket	291
Gallery Panel	8	Peninsula Surface, Rectangular End	234
Glass Back Panel	373	Peninsula Surface, Rectangular End, Center	252
Glass Back Panel, Used with Floating Shelf	375	Peninsula Surface, Rectangular End, Single	249
Grommet Kit, Surface	329	Peninsula Surface, Rectangular End, Transition, Double	245
Hardwire Mounting Kit	83	Peninsula Surface, Rectangular End, Transition Left	237
Hardwire Mounting Kit, Low Credenza Height	84	Peninsula Surface, Rectangular End, Transition Right	241
Infill, Open Support with Tapered Foot, Frame Attached	298	Peninsula Surface, Round End	255
Inline Glass Back Panel, Overhead	378	Peninsula Surface, Round-End, Center	274
Laminate Screen, Surface Attached	451	Peninsula Surface, Round-End, Single	270
Laminate Screen, Surface Attached with Modesty	453	Peninsula Surface, Round-End, Transition, Double	266
Lower Open Tile	142	Peninsula Surface, Round-End, Transition Left	258
Lower Power/Data Tile	131	Peninsula Surface, Round-End, Transition Right	262
Lower Power/Data Tile, Low Credenza Height	137	Performance Task Light	458
Lower Tile	120	Power Entry, External Direct Connect	88
Markerboard, Storage Cabinet, Frame Top Mounted	334	Power Entry, Internal Direct Connect, 4 Circuit	87
Marker/Eraser Holder	155	Power Entry, New York City	89
Meridian® Vertical Tower Attachment Bracket	319	Power Harness Extender	85
Metal Pencil Drawer	422	Power Harness, Low Credenza Height	82
Modesty Panel	442	Power Harness, Lower Power/Data Tile	80
Monitor Arm Retrofit Kit, Upper Rail Tile	162	Power Harness, Upper Power/Data Tile	81
Off-Module 90° Connector Kit	39	Power Jumper	86
Off-Module Change-of-Height Support Rail	41	Privacy Door	19
Off-Module Upper Tile	153	Privacy Door Lock Post Kit	21
Open Base Retrofit Kit, Tapered Foot	34	Privacy Panel	439
Open Support, Architectural Foot, Frame Attached	299	Rail Tile	158
Open Support Leg, Architectural Foot	312	Receptacle, 4 Circuit, 20 Amp	96
Open Support Leg, Architectural Foot, Peninsula/D-Shaped Surface		Receptacle, 15 Amp (package of 6)	94
Attached	302	Rectangular Surface	177
Open Support Leg, Tapered Foot, Peninsula/D-Shaped Surface		Rectangular Surface, Transition, Center	201
Attached	301	Rectangular Surface, Transition, Double	198
Open Support, Tapered Foot, Frame Attached	297	Rectangular Surface, Transition, Single	193
Overhead Storage Cabinet, Full Enclosure	397	Retrofit Base Cover for Power Entry	35
Overhead Storage Cabinet, Hinged Doors	405, 346	Screen	437
Overhead Storage Cabinet, Open	391, 342	Shelf Divider, Angled	389
Overhead Storage Cabinet, Partial Enclosure	393	Signature Screen, Surface-Attached	423
Overhead Storage Cabinet, Sliding Doors	359	Single Sided Base Cover Kit	30
Overhead Storage Cabinet, Sliding Full Enclosure	355	Squared-Edge Corner Wedge	283
Overhead Storage Cabinet, Sliding Partial Enclosure	351	Squared-Edge Transaction Surface	285
Overhead Storage Cabinet, Thin Top, Open	402	Square Open Support Leg	310
Overhead Storage Cabinet, Thin Top with Hinged Doors	409	Square Open Support Leg, Peninsula Attached	304
Pari Screen, Delineation	431	Stacking Frame	15

Index by Product Name *continued*

Stiffener	309
Storage Cabinet, Frame Top, Mounted, Open	330
Support Bracket, Low Credenza-to-Frame	14
Support Leg, Post	306
Support Panel, Frame-Attached	322, 296
Support Panel, Tapered Foot, Frame Attached	295
Surface Cantilever	289
Surface Ganging Bracket	290
Surface Support, Low Credenza, Adjustable Height	308
Surface Support, Low Credenza, Fixed Height	307
Surface Support Rail	293
Tackboard	417
Tackboard Cable Manager	420
Tackboard, Storage Cabinet, Frame Top Mounted	333
Thin-Profile Stacking Window	17
Tile Adapters, Wall Strip	76
Tile Trim, Wall Strip	77
Toggle Wall Strip Anchor	75
Tool Bar	163
Top Channel Cable Support	16
To-The-Floor Extended-Width Full-Height Tile	117
To-The-Floor Extended-Width Lower Tile	129
To-The-Floor Full-Height Tile	114
To-The-Floor Full-Height Tile, Architectural	172
To-The-Floor Lower Tile	126
Tu® Storage Tower Attachment Bracket	318
Twist™ LED Task Light	464
Universal Post Leg	305
Universal Post Leg, Frame Attached	300
Upmount Screen	22
Upper Monitor Arm Tile	160
Upper Open Tile	166
Upper Power/Data Tile	150
Upper Tile	144
Upper Window Tile	164
Upper Window Tile, Custom Glass	167
Utility Shelf	387
Utility Task Light	462
Veneer Tile, Matched Set	169
Vertical Cable Manager	328
Vertical Trim, Wall Strip	78
Wall Fastener	72
Wall Start	71
Wall Start Filler	73
Wall Strip	74
Work Surface Support Bracket	292

Index by Product Number

A3390. B-Style Flipper Door Back Panel	page(s) 377	FT123. 90° Connector Cover	44
E2931. Work Surface Support Bracket	292	FT126. 90° Connector Top Cap	66
E3190. E-Style Flipper Door Back Panel	386	FT127. Off-Module 90° Connector Kit	39
E3234. Utility Shelf	387	FT128. Frame-to-Frame Connection Hardware	36
FM930. Canvas Vertical Tower Attachment Bracket	317	FT131. 120° Universal Connector	38
FT2A1. Open Support, Architectural Foot, Frame Attached	299	FT132. 120° Universal Stacking Connector	43
FT2A2. Open Support Leg, Architectural Foot, Peninsula/D-Shaped Surface Attached	302	FT133. 120° Connector Cover	48
FT2B1. Universal Post Leg, Frame Attached	300	FT136. 120° Connector Top Cap	69
FT2B2. Universal Post Leg	305	FT140. Power Entry, External Direct Connect	88
FT2E2. Support Panel, Frame-Attached	296	FT141. Power Entry, New York City	89
FT2F2. Open Support Leg, Tapered Foot, Peninsula/D-Shaped Surface Attached	301	FT142. Ceiling Power Entry, End of Run	90
FT2G2. Support Panel, Frame-Attached	322	FT143. Ceiling Power Entry, Connector	92
FT11A. Frame Top Cap, Architectural	62	FT144. Power Entry, Internal Direct Connect, 4 Circuit	87
FT11B. Frame Top Cap, Architectural, Privacy Door	65	FT150. Base Power Harness	79
FT12A. 90° Connector Top Cap, Architectural	68	FT151. Power Harness Extender	85
FT12B. 90° Connector Cover, Architectural	46	FT152. Power Harness, Lower Power/Data Tile	80
FT14A. Ceiling Power Entry, Architectural Trim, Connector	93	FT153. Power Harness, Upper Power/Data Tile	81
FT15A. Power Harness, Low Credenza Height	82	FT154. Power Jumper	86
FT15C. Hardwire Mounting Kit, Low Credenza Height	84	FT155M Controlled Receptacle, 15 Amp (package of 6)	95
FT15U. Dual USB Charging Module, 2 Amp	99	FT155. Receptacle, 15 Amp (package of 6)	94
FT16A. Finished End, Architectural	53	FT156M Controlled Receptacle, 4-Circuit, 20 Amp	97
FT16B. Finished End, Architectural, Change-Of-Height	57	FT156. Receptacle, 4 Circuit, 20 Amp	96
FT16D. Finished End, Architectural, Privacy Door	64	FT157. Hardwire Mounting Kit	83
FT16G. Finished End, for use with Gallery Panel	58	FT160. Finished End	51
FT17R. Lower Power/Data Tile	131	FT161. Finished End, Change of Height	55
FT18A. Full-Height Tile, Architectural	106	FT162. Retrofit Base Cover for Power Entry	35
FT18D. Full-Height Tile, Architectural with Power and Data	174	FT163. Base Cover Retrofit Kit	32
FT19C. Cable Management Channel	326	FT164. Open Base Retrofit Kit, Tapered Foot	34
FT29A. Peninsula Support Bracket	291	FT165. Connector Base Filler	50
FT29B. Surface Ganging Bracket	290	FT166. Off-Module Change-of-Height Support Rail	41
FT36R. Extended-Width Lower Power/Data Tile	135	FT167. Tile Trim, Wall Strip	77
FT37R. Lower Power/Data Tile, Low Credenza Height	137	FT170. Lower Tile	120
FT38A. To-The-Floor Full-Height Tile, Architectural	172	FT171. Lower Power/Data Tile	131
FT39R. Extended-Width Lower Power/Data Tile, Low Credenza Height	140	FT172.	
FT110. Frame	5	FT174. Lower Open Tile	142
FT111. Stacking Frame	15	FT175. Rail Tile	158
FT112. Frame Top Cap	60	FT176. Veneer Tile, Matched Set	169
FT113. Upmount Screen	22	FT178. Upper Monitor Arm Tile	160
FT114. Frame Top Screen	24	FT179. Monitor Arm Retrofit Kit, Upper Rail Tile	162
FT115. Gallery Panel	8	FT180. Full-Height Tile	108
FT117. Architectural Foot	13	FT181. Upper Tile	144
FT118. Privacy Door	19	FT183. Upper Window Tile	164
FT121. 90° Universal Connector	37	FT184. Upper Power/Data Tile	150
FT122. 90° Universal Stacking Connector	42	FT185. Upper Open Tile	166
		FT186. Upper Window Tile, Custom Glass	167
		FT187. Thin-Profile Stacking Window	17
		FT188. Off-Module Upper Tile	153

Index by Product Number *continued*

Index: Product Number

FT189. Acoustical Insert	171	FT432. E-Style Shelf	370
FT190. Wall Start	71	FT489. Coat Hook - Frame Attached	157
FT191. Wall Strip	74	FT490. Coat Hook	156
FT192. Tile Adapters, Wall Strip	76	FT491. Tackboard, Storage Cabinet, Frame Top Mounted	333
FT193. Cable Tray	100	FT492. Markerboard, Storage Cabinet, Frame Top Mounted	334
FT194. Frame Grommet	102	FT900. Tool Bar	163
FT197. Vertical Trim, Wall Strip	78	FT910. Top Channel Cable Support	16
FT198. Cable Management Clips	463, 104	FT920. Wall Start Filler	73
FT199. Cable Management Trough	325	FT963. Single Sided Base Cover Kit	30
FT280. Squared-Edge Transaction Surface	285	FT992. Privacy Door Lock Post Kit	21
FT290. Surface Cantilever	289	FTE1A. Rectangular Surface, Transition, Single	193
FT291. Support Panel, Tapered Foot, Frame Attached	295	FTE1B.	
FT292. Support Bracket, Low Credenza-to-Frame	14	FTE1C.	
FT293. Bookcase Surface Support	294	FTE1D.	
FT294. Open Support, Tapered Foot, Frame Attached	297	FTE1E. Rectangular Surface, Transition, Center	201
FT295. Surface Support Rail	293	FTE1F.	
FT297. Infill, Open Support with Tapered Foot, Frame Attached	298	FTE1G.	
FT298. Surface Support, Low Credenza, Fixed Height	307	FTE1H. Rectangular Surface, Transition, Double	198
FT299. Surface Support, Low Credenza, Adjustable Height	308	FTE1J.	
FT350. Signature Screen, Surface-Attached	423	FTE1K.	
FT351. Pari Screen, Surface Attached	425	FTE10. Rectangular Surface	177
FT353. Pari Screen, Surface Attached with Modesty	429	FTE11. Concave Rectangular Surface	183
FT354. Pari Screen, Delineation	431	FTE12. Curvilinear Surface	189
FT355. Pari Screen, Frame Top	27	FTE15. About Face™ Bridge Surface	280
FT356. Flat Edge Screen, Surface Attached	427	FTE18. Bowtie Rectangular Surface	186
FT357. Flat Edge Screen, Surface Attached with Modesty	444	FTE20. Corner Surface	205
FT358. Flat Edge Screen, Delineation	446	FTE21. Concave Corner Surface	208
FT359. Flat Edge Screen, Frame Top	448	FTE22. Extended Corner Surface, Rectangular End	213
FT360. Laminate Screen, Surface Attached	451	FTE23.	
FT361. Laminate Screen, Surface Attached with Modesty	453	FTE26. Extended Corner Surface, Round End	219
FT370. Extended-Width Lower Tile	123	FTE27.	
FT371. Lower Power/Data Tile, Low Credenza Height	137	FTE36. D-Shaped Surface	277
FT372.		FTE40. 120° Corner Surface, 90° Ends	224
FT375. To-The-Floor Lower Tile	126	FTE41. 120° Corner Surface, 120° Ends	227
FT376. To-The-Floor Extended-Width Lower Tile	129	FTE44. 120° Corner Surface, Extended 90° Ends	230
FT380. Extended-Width Full Height Tile	111	FTE50. Peninsula Surface, Rectangular End, Center	252
FT381. Extended-Width Upper Tile	147	FTE51. Peninsula Surface, Rectangular End, Single	249
FT385. To-The-Floor Full-Height Tile	114	FTE53. Peninsula Surface, Rectangular End, Transition, Double	245
FT386. To-The-Floor Extended-Width Full-Height Tile	117	FTE54.	
FT410. F-Style Sliding Door Storage Unit	335	FTE55. Peninsula Surface, Rectangular End, Transition Right	241
FT411. F-Style Shelf	340	FTE56.	
FT412. F-Style Storage Unit Back Panel	341	FTE57. Peninsula Surface, Rectangular End, Transition Left	237
FT414. F-Style Upmount Sliding Door Storage Unit	338	FTE58.	
FT415. Storage Cabinet, Frame Top, Mounted, Open	330	FTE60. Peninsula Surface, Round-End, Center	274
FT420. B-Style Flipper Door Unit	363	FTE61. Peninsula Surface, Round-End, Single	270
FT422. B-Style Shelf	366	FTE62.	
FT430. E-Style Flipper Door Unit	368	FTE63. Peninsula Surface, Round-End, Transition, Double	266

Index by Product Number *continued*

FTE64.		
FTE65.	Peninsula Surface, Round-End, Transition Right	262
FTE66.		
FTE67.	Peninsula Surface, Round-End, Transition Left	258
FTE68.		
FTS10.	Rectangular Surface	177
FTS11.	Concave Rectangular Surface	183
FTS12.	Curvilinear Surface	189
FTS15.	About Face™ Bridge Surface	280
FTS18.	Bowtie Rectangular Surface	186
FTS20.	Corner Surface	205
FTS21.	Concave Corner Surface	208
FTS22.	Extended Corner Surface, Rectangular End	213
FTS23.		
FTS24.	Corner Surface with Input Platform Cutout	211
FTS26.	Extended Corner Surface, Round End	219
FTS27.		
FTS34.	Peninsula Surface, Rectangular End	234
FTS35.	Peninsula Surface, Round End	255
FTS36.	D-Shaped Surface	277
FTS40.	120° Corner Surface, 90° Ends	224
FTS41.	120° Corner Surface, 120° Ends	227
FTS44.	120° Corner Surface, Extended 90° Ends	230
FTT1A.	Rectangular Surface, Transition, Single	193
FTT1B.		
FTT1C.		
FTT1D.		
FTT1E.	Rectangular Surface, Transition, Center	201
FTT1F.		
FTT1G.		
FTT1H.	Rectangular Surface, Transition, Double	198
FTT1J.		
FTT1K.		
FTT10.	Rectangular Surface	177
FTT11.	Concave Rectangular Surface	183
FTT12.	Curvilinear Surface	189
FTT15.	About Face™ Bridge Surface	280
FTT18.	Bowtie Rectangular Surface	186
FTT20.	Corner Surface	205
FTT21.	Concave Corner Surface	208
FTT22.	Extended Corner Surface, Rectangular End	213
FTT23.		
FTT26.	Extended Corner Surface, Round End	219
FTT27.		
FTT36.	D-Shaped Surface	277
FTT40.	120° Corner Surface, 90° Ends	224
FTT41.	120° Corner Surface, 120° Ends	227
FTT44.	120° Corner Surface, Extended 90° Ends	230
FTT50.	Peninsula Surface, Rectangular End, Center	252
FTT51.	Peninsula Surface, Rectangular End, Single	249
FTT53.	Peninsula Surface, Rectangular End, Transition, Double	245
FTT54.		
FTT55.	Peninsula Surface, Rectangular End, Transition Right	241
FTT56.		
FTT57.	Peninsula Surface, Rectangular End, Transition Left	237
FTT58.		
FTT60.	Peninsula Surface, Round-End, Center	274
FTT61.	Peninsula Surface, Round-End, Single	270
FTT62.		
FTT63.	Peninsula Surface, Round-End, Transition, Double	266
FTT64.		
FTT65.	Peninsula Surface, Round-End, Transition Right	262
FTT66.		
FTT67.	Peninsula Surface, Round-End, Transition Left	258
FTT68.		
FV2A2.	Open Support Leg, Architectural Foot	312
FV2D1.	Square Open Support Leg, Peninsula Attached	304
FV2D2.	Square Open Support Leg	310
FV2E2.	Closed Support Leg	314
FV43C.	Overhead Storage Cabinet, Open	342
FV43F.	Overhead Storage Cabinet, Sliding Full Enclosure	355
FV43H.	Overhead Storage Cabinet, Hinged Doors	346
FV43P.	Overhead Storage Cabinet, Sliding Partial Enclosure	351
FV43S.	Overhead Storage Cabinet, Sliding Doors	359
FV44M.	Overhead Storage Cabinet, Thin Top with Hinged Doors	409
FV298.	Fixed Surface Support, Low Credenza, Power Chase	320
FV360.	Pari Screen, Storage Attached	433
FV361.	Flat Edge Screen, Storage Attached	435
FV434.	Floating Shelf, Aluminum	371
FV440.	Overhead Storage Cabinet, Open	391
FV441.	Overhead Storage Cabinet, Partial Enclosure	393
FV442.	Overhead Storage Cabinet, Full Enclosure	397
FV445.	Overhead Storage Cabinet, Thin Top, Open	402
FV446.	Overhead Storage Cabinet, Hinged Doors	405
FV490.	Common Thin Top, Overhead Storage	415
FV617.	Cast LED Light	457
FV618.	Cast LED Task Light, Valance	461
FV689.	Support Leg, Post	306
FV692.	Canvas Cabinet/Wall Attachment Bracket	316
FV693.	Privacy Panel	439
FV694.	Screen	437
FV695.	Cable Manager	324
FV696.	Stiffener	309
FV697.	Modesty Panel	442

Index by Product Number *continued*

Index: Product Number

FV698. Vertical Cable Manager	328
FV970. Glass Back Panel	373
FV971. Inline Glass Back Panel, Overhead	378
FV972. Glass Back Panel, Used with Floating Shelf	375
FV980. Tackboard	417
FV982. Grommet Kit, Surface	329
FV984. Cord Manager	390
FV985. Tackboard Cable Manager	420
G1189. Communication Port Faceplate Extender	103
G1189. Communication Port Faceplate Reducer	101
G1331. Cord Cleat	327
G6114. Performance Task Light	458
G6115.	
G6116.	
G6117.	
G6120. Energy-Efficient Task Light	455
G6121.	
G6123.	
G6136. Utility Task Light	462
G6137.	
G6160. Twist™ LED Task Light	464
G7330. Shelf Divider, Angled	389
G9999. Controlled Receptacle Decal (12 per sheet)	98
LG692. Tu® Storage Tower Attachment Bracket	318
MTAB. Meridian® Vertical Tower Attachment Bracket	319
X1191. Toggle Wall Strip Anchor	75
X1192. Wall Fastener	72
X1313. Communication Faceplate Extender	105
X3710. C-Style Flipper Door	381
X3730. C-Style Shelf	383
X3750. C-Style Flipper Door Unit	379
X3790. C-Style Flipper Door Back Panel	385
X3910. Component Brace	388
Y2091. Squared-Edge Corner Wedge	283
Y5010. Pencil Drawer	421
Y5012. Metal Pencil Drawer	422
Y6470. Flute™ Personal Light	465
Y7231. Marker/Eraser Holder	155

20-Day or Less/Assigned Lead-Time Order Information

20-Day or Less and Assigned Lead-Time Programs

20-day or less and assigned lead-time products are designed for established Herman Miller dealers with pre-approved credit.

Products are distributed from multiple manufacturing facilities across the United States. All products and options not designated by an Assigned Lead-Time icon **A** will ship in 20 business days or less after being acknowledged by Herman Miller. Products and options designated by an **A** are on the assigned lead-time program and will ship in 20 days, less than 20 days, or more than 20 days from order acknowledgement.

Ordering Procedure

Please place orders through Order Manager. If this is not available to you, place orders through mail or fax. Verbal purchase orders will not be accepted.

Order Entry fax number for Passage®, 5000 Series, and Meridian® Filing and Storage: (616) 846 9236.

Order Entry fax number for all other products:
(616) 654 3085.

For more information, contact your Customer Care representative at:
(866) 854 3048 EXT 3400.

Shipments and Delivery

Per Herman Miller Terms and Conditions.

Changes and Cancellation

Per Herman Miller Terms and Conditions.



Keyed-Alike Information

Keyed-Alike Locks

All components with locks may be specified keyed alike. Products with keyed-alike locks will be shipped with lock chassis installed.

Installation of lock cylinders will be on-site according to instructions provided. Herman Miller, Inc., will not be responsible for lock cylinder installation.

When specifying product keyed-alike, include separate lines on your order for the lock cylinders.

For Action Office®, Ethospace®, Passage®, Quadrant®, Resolve®, and Supplemental products, list cylinder part number and key number (232092-XXX); select a key number (or numbers) between 226 and 427, excluding numbers 408 and 412.

The following products require a different lock cylinder part number. Specify UKY001-XXX for these products only; select a key number (or numbers) between 226 and 427, excluding numbers 408 and 412.

- A3013.
- A3053.
- G5180.
- G5181.
- G5280.

The keys provided in 232092-XXX and UKY001-XXX kits work with either cylinder type, provided the key numbers match.

For Tu® Storage, Canvas Office Landscape®, 5000 Series, and Meridian® Storage, see the following charts.

Keyed-alike locks are field installed.

To order keyed-alike locks for Action Office® Series 1 and 2 door panels, please contact Customer Care.

A master key can be used to open any lock on an attached or freestanding component. In addition, a removal key or lock change tool is required to remove lock plugs. Customers interested in ordering master keys, removal keys, or lock change tools should contact Customer Care.

For Canvas overhead and lower storage units, specify as follows:

Specification Code	Part Number	Color	Lock Series
KA	1B2JK7-XXX ¹	chrome	UM series 226-427

For Canvas Metal Storage, Meridian Storage, Tu Storage, and 5000 Series desk components with pedestals, specify as follows:

Specification Code	Key Number	Color	Lock Series
KA	232092-XXX ¹	black	UM series 226-427
KA	1B2JK7-XXX ¹	chrome	UM series 226-427

For 5000 Series flipper door unit with bezel or credenza storage cabinet with bezel, specify as follows:

Specification Code	Key Number	Color	Lock Series
KA	232092-XXX ¹	black	UM series 226-427

Key Number:

XXX¹ = a key number between 226 and 427 (excluding 408 and 412)

Vary Easy Program

Program Overview

Vary Easy is a program designed to help dealers specify standard products with a larger breadth of options. For example, depending on the type of product being specified, choices include additional size, finish, edge types, and cable management features. Vary Easy 3D, specIT, and third-party text-based specification packages support the Vary Easy program. Vary Easy 3D enables designers to create a 3D image, CAD symbols, and a price book page. A Vary Easy product number is assigned for each product as the user selects specific options. Once the product is completely specified, the order can be submitted via Kiosk's Order Manager or a dealer's business system.

Accessing and Specifying Vary Easy

To view the full product vocabulary, go to the Vary Easy Product Offering on Kiosk. To specify Vary Easy, go to the Vary Easy 3D website on Kiosk, specIT, or your third-party text-based specification package.

Once you've made your product line selection, continue to follow through each option and enter the specific options that represent the product you need. When the product is fully specified, Vary Easy will generate an orderable product number and instantly calculate a price.

Note: Failure to completely specify a product will cause a delay in order acknowledgements. Be sure to make a selection for all options offered.

The acknowledgement process for Vary Easy products is the same as for any standard order. Vary Easy products ship with a standardized lead time and are competitively priced.

For more information, contact your Customer Care Line at (866) 854 3048 EXT 3400.

Fire Retardancy for Proprietary Fabrics

Action Office® Products

The panel types listed below, when covered with the textiles identified below, meet the Class A requirements for flame spread and smoke development as specified by the National Fire Protection Association (NFPA) in the 2015 Life Safety Code No. 101, and the Underwriter's Laboratories requirements for use with energy distribution components (listed by UL under Office Furnishings 1286).

Panel Type	
fabric covered	stacking fabric covered
acoustical	tackable acoustical barrier partial-glazed

Textiles			
Bento	Gem ¹	Loom	Slant
Chain	Glaze	Medley	Stitches
Code	Glisten	Pins and Needles	Strands
Connection	Grasscloth	Quilty	String Plaid
Cord	Grosgrain ¹	Resonance	Tailored
Crepe	Ground Cloth®	Rivet	Twist ¹
Crossing	Hopsak	Savannah	
Current	Horizon	Silkworm	
Frost	Kira 2	Sironetta	

¹ Fabric not available on acoustical panels.

Action Office Products

The panel type listed below meets the Class A requirements for flame spread and smoke development as specified by the National Fire Protection Association (NFPA) in the 2015 Life Safety Code No. 101, and the Underwriter's Laboratories requirements for use with energy distribution components (listed by UL under Office Furnishings 1286).

Panel Type
hard-surfaced

Ethospace® Products

Acoustical tiles, when covered with the textiles identified below, meet the Class B requirements for flame spread and smoke development as specified by the NFPA in the 2015 Life Safety Code No. 101, and the Underwriter's Laboratories requirements for use with electrical components (listed by UL under Office Furnishings 1286).

Face tiles and beltline communication tiles, when covered with the textiles identified below, meet the Class A requirements for flame spread and smoke development as specified by the National Fire Protection Association (NFPA) in the 2015 Life Safety Code No. 101, and the Underwriter's Laboratories requirements for use with electrical components (listed by UL under Office Furnishings 1286).

Tackable tiles, when covered with the textiles identified below, meet the Class B requirements for flame spread and smoke development as specified by the NFPA in the 2015 Life Safety Code No. 101, and the Underwriter's Laboratories requirements for use with electrical components (listed by UL under Office Furnishings 1286).

Tile Type	
face tile	beltline face tile
tackable tile	cable access tile
acoustical tile	cable channel tile

Textiles			
Chain	Gem	Loft	Silkworm
Code	Glaze	Loom	Sironetta
Connection	Glisten	Medley	Slant
Cord	Grasscloth	Moiré	Strands
Crepe	Grosgrain	Pins and Needles	String Plaid
Crossing	Ground Cloth®	Quilty	Tailored
Current	Hopsak	Resonance	Twist
Fish Net	Horizon	Rivet	Well Suited
Frost	Kira 2	Savannah	

Fire Retardancy — Workspaces

continued

Canvas Office Landscape® Products

Tiles, when covered with the textiles identified below, meet the Class A requirements for flame spread and smoke development as specified by the National Fire Protection Association (NFPA) in the 2015 Life Safety Code No. 101, and the Underwriter's Laboratories requirements for use with electrical components (listed by UL under Office Furnishings 1286).

Tile Type

lower tile	lower power/data tile
full height tile	off-module upper tile
upper tile	upper power/data tile

Textiles

Bento	Gem	Loom	Slant
Chain	Glaze	Medley	Stitches
Code	Glisten	Moiré	Strands
Connection	Grasscloth	Pins and Needles	String Plaid
Cord	Grosgrain	Quilty	Tailored
Crepe	Ground Cloth	Resonance	Tape
Crossing	Hopsak	Rivet	Twist
Current	Horizon	Savannah ¹	Well Suited
Fish Net	Kira 2 ¹	Silkworm	
Frost	Loft ¹	Sironetta	

¹ Canvas tiles, when covered in Kira 2, Loft, or Savannah meet the Class B requirements for flame spread and smoke development as specified by the NFPA in the 2015 Life Safety Code No. 101.

Fire Retardancy for Maharam® Fabrics

The panel types, tile types, and textiles listed below are recognized by the Underwriters Laboratories under the UL Component Recognition Program. The following UL recognized fabrics, when used on the panel or tile types listed below, fall within a Class C requirement for flame spread and smoke development as specified by the National Fire Protection Association (NFPA) in the 2015 Life Safety Code No. 101. The panels and tiles are incomplete in construction features when tested. The UL Component Recognition Program does not provide evidence of UL listing or labeling, which may be required by installation codes or standards.

Tackable tiles, when covered with the textiles identified below, meet a minimum Class C requirement for flame spread and smoke development as specified by the NFPA in the 2015 Life Safety Code No. 101, and the Underwriters Laboratories requirements for use with electrical components (listed by UL under Office Furnishings 1286).

Action Office Products

Panel Type	
fabric covered	stacking fabric covered
acoustical	tackable acoustical barrier partial-glazed

Textiles	
Adjourn	Parallel ¹
Crisp ²	Plait
Glance	Reply
Glint	Sharkskin 2
Hum	Skein
Manner	Sketch
Metric	Spiral
Mode	Ticker
Morse	Unit

¹ Fabric not available on acoustical panels.

² Fabric not available on partial-glazed panels.

Ethospace Products

Tile Type	
face tile	beltline face tile
tackable tile	cable access tile
acoustical tile	cable channel tile

Textiles	
Adjourn	Parallel
Crisp ¹	Plait
Glance	Sharkskin 2
Glint	Skein
Hum	Sketch
Manner	Spiral
Messenger	Ticker
Morse	

¹ Fabric not available on tackable tiles.

Canvas Office Landscape Products

Tile Type	
lower tile	lower power/data tile
full height tile	off-module upper tile
upper tile	upper power/data tile

Textiles	
Crisp	Plait
Hum	Reply
Manner	Sharkskin 2
Medium	Skein
Messenger	Sketch
Metric	Spiral
Morse	Ticker
Parallel	Unit

Stain-to-Match Program

Stain-to-Match Program

Program Overview

The Stain-to-Match program gives you the option of using veneer finishes that are not listed in the standard offering. The program allows Herman Miller to match a customer's existing recut or natural veneer, or create a new finish that is unique to an installation.

Specific information on approval, ordering, pricing, and warranty for the Stain-to-Match program is listed below. Questions and requests for assistance may be directed to Herman Miller Options at:

(800) 654 3910

Stain-to-Match Process

1. Fill out the Options Stain-to-Match Request Form and send along with a color sample (2" x 3" minimum) to the Herman Miller Options Applications Team at the address provided on the form. The form can be found on Omni.
2. Within 7-10 working days, Herman Miller Options will send a sample of the color-matched stain on Herman Miller veneer to the requester for the customer's signed approval.
3. If the sample meets the customer's approval, sign the reverse side of the sample, scan and email the approval to:
options@hermanmiller.com.
4. After the stain has been approved, a formal quotation with special number and pricing can be provided, or the product can be specified through the Vary Easy program, if available. Work with the Options team on final product needs and how to specify.
5. A purchase order can then be placed.

Stain-to-Match Warranty

Herman Miller warrants its products to be free from defects in craftsmanship from the date of delivery for the applicable warranty period. Herman Miller is responsible for the physical properties of the veneers available through the Stain-to-Match program, which include:

- STA: Stain-to-Match on Recut Ash
- STB: Stain-to-Match on Beech
- STC: Stain-to-Match on Cherry
- STD: Stain-to-Match on Oak
- STK: Stain-to-Match on Reltech Anigre (Geiger)
- STM: Stain-to-Match on Recut Mahogany
- STP: Stain-to-Match on Maple
- STU: Stain-to-Match on Walnut (Geiger)

See your specification tool for product specific finish offering limitations.

Surface Edge Styles

Surface Edge Styles

Squared Edge

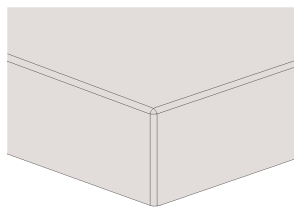

My Studio Edge

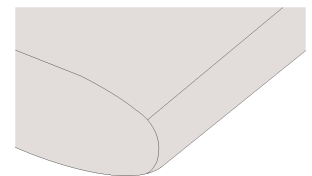
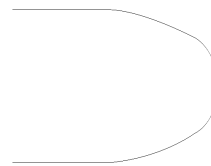

Eased Edge

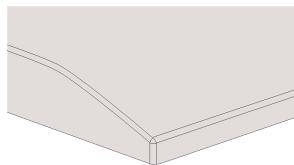
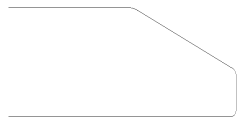

Passage Edge

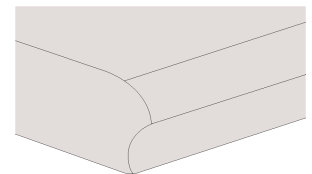

Thin Edge

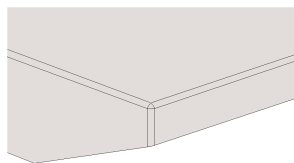





Canvas Office Landscape® Connectors and Covers Matrix

Use the following matrix to confirm your connector, cover, and top cap selection based on the frame heights specified. This matrix represents a subset of the possible frame and connector applications and shows the correct connector, connector cover, and top cap to specify.

For additional applications and information, see the Canvas Office Landscape® Planning Guide.

Legend

Frames

-  Same Height/Tallest
-  11" Drop in Height
-  22" Drop in Height

Connectors

35" and 46" High Frames



 .46

57", 68" and 79" High Frames

 .57

Covers

One Side

-  .1 + Required Height
-  (Shown When 2 are Required)

Two Sides

 .2 + Required Height

Three Sides

 .3 + Required Height

Top Caps

 .1A

 .2A

 .2B

 .3A

 .4A

2-Way, Equal-Height Frames

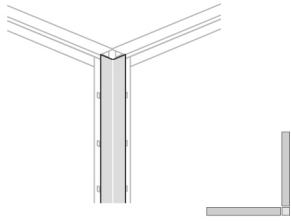

Frames 35/35



Frames 46/46



Frames 57/57



Frames 68/68



Frames 79/79



2-Way, 1 Frame 11" Lower

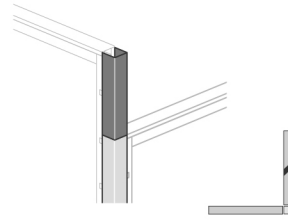

Frames 46/35

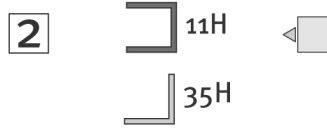

Frames 57/46

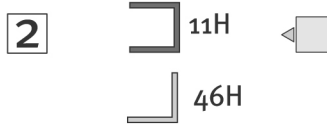

Frames 68/57

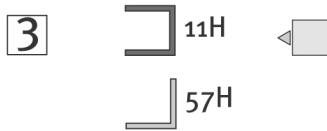

Frames 79/68



2-Way, 1 Frame 22" Lower

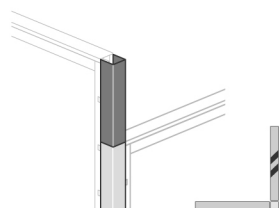

Frames 57/35



Frames 68/46

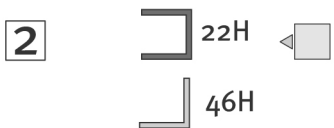

Frames 79/57

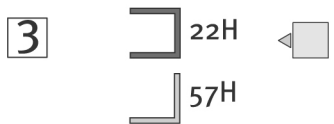

3-Way, Equal-Height Frames

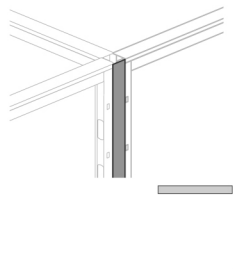

Frames 35/35/35

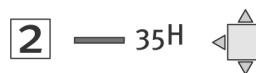

Frames 46/46/46

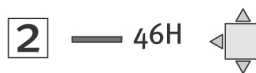

Frames 57/57/57

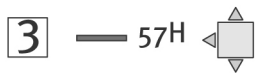

Frames 68/68/68

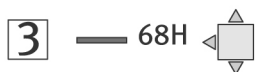

Frames 79/79/79

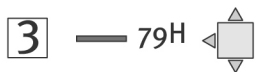

Canvas Office Landscape® Connectors and Covers Matrix *continued*

Appendix: Canvas Office Landscape® Connectors and Covers Matrix

3-Way, 1 Frame 11" Higher

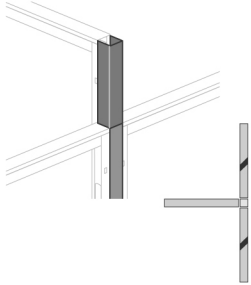

Frames 35/46/35

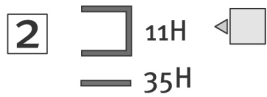

Frames 46/57/46



Frames 57/68/57

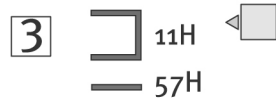

Frames 68/79/68



3-Way, 1 Frame 22" Higher

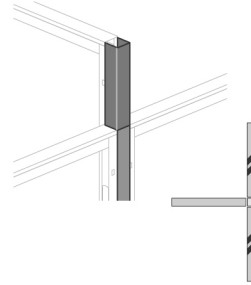

Frames 35/57/35



Frames 46/68/46



Frames 57/79/57

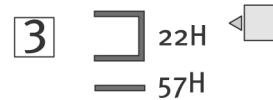

4-Way, Equal-Height Frames

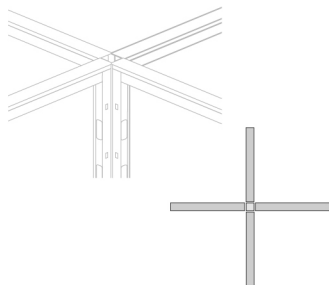

Frames 35

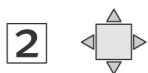

Frames 46

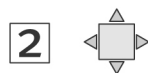

Frames 57

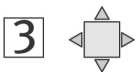

Frames 68

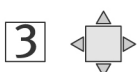

Frames 79

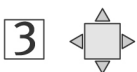

**4-Way, 2 180° Equal-Height Frames, 2 180° Frames
11" Lower**

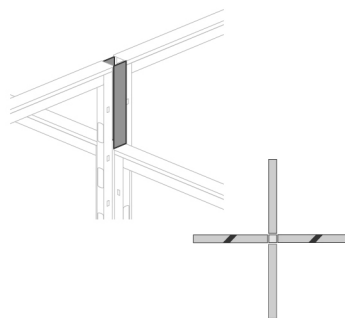

Frames 46/35/46/35

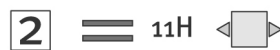

Frames 57/46/57/46

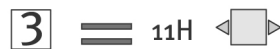

Frames 68/57/68/57

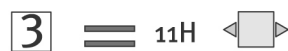

Frames 79/68/79/68

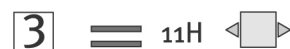

Canvas Office Landscape® Connectors and Covers Matrix *continued*

Appendix: Canvas Office Landscape® Connectors and Covers Matrix

4-Way, 2 180° Equal-Height Frames, 2 180° Frames 22" Lower

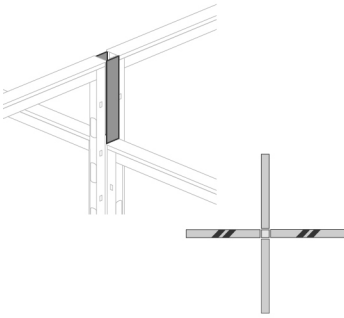

Frames 57/35/57/35

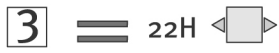

Frames 68/46/68/46

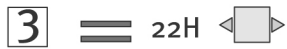

Frames 79/57/79/57

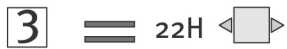

4-Way, 2 90° Frames 11" Lower, 1 Frame 22" Lower

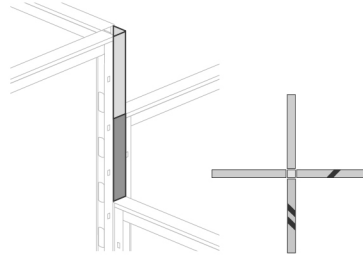

Frames 57/57/46/35

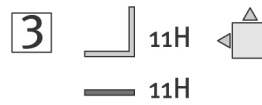

Frames 68/68/57/46

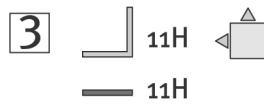

Frames 79/79/68/57

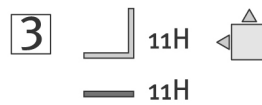

Customer's Own Material/ Customer's Own Leather Order Information — Cushion Tops

Customer's Own Material/Customer's Own Leather

Program Overview

The Customer's Own Material (COM) and Customer's Own Leather (COL) program gives you the option of using textiles other than those listed. Herman Miller will test textiles for application to Herman Miller products and will process orders for those with approved COM/COL textiles only. COM/COL are assigned lead time textiles.

Omni lists an overview of fabrics and leathers that have been tested and indicates whether or not they were approved for application to Herman Miller products.

Specific information on the terms and conditions, testing, approval, and ordering process for COM/COL is listed below. Questions about the COM/COL program and requests for assistance may be directed to your COM representative at:

(616) 654 3400

(866) 854 3048 EXT 6543400

Customer's Own Material/Customer's Own Leather Warranty

Herman Miller does not warrant COM/COL textiles. COM/COL textiles are tested for application only; they are not tested for performance. The Herman Miller warranty does apply to the underlying products.

Suppliers of COM/COL textiles are responsible for color consistency within commercial tolerances, UV stability, and resistance to soiling and perspiration.

Customer's Own Material/Customer's Own Leather Pricing

COM is a Category 1 fabric. There are no application charges for COM fabrics. COL is a Category 7 textile; refer to prices on specific products to determine the application charge.

Ordering and payment for COM/COL textile yardage are the responsibility of the customer and the textile supplier.

If desired, Herman Miller will purchase COM textiles directly from True Textiles, C.F. Stinson, Luna Textiles, Maharam, and Momentum Textiles to simplify ordering and shipment. For this service, refer to the Supplier Connection program.

Application Note

Herman Miller does not guarantee that Customer's Own Material (COM) fabric patterns will align across panels/tiles or from one screen to the next. We also do not guarantee that COM fabric designs will be positioned consistently in the same location across several panels, tiles, or screens.

Textile Approval

1. Select a COM/COL textile.
2. If your textile is not listed on Omni, obtain a test number from a COM representative at (616) 654 3400. You can also submit your request within Omni. Please have the following information ready before calling: textile name, number, pattern, and the product you will apply it to.
3. Herman Miller will notify you of approval or disapproval within 4 days from receipt of the test yardage.

Customer's Own Material/ Customer's Own Leather Order Information — Cushion Tops

continued

Ordering Products with COM/COL

1. Refer to the specific products to determine the yardage required for COM/COL textiles.
2. If your textile is not listed on Omni, call a COM representative at (616) 654 3400 or (866) 854 3048 EXT 6543400. The representative will assign an identification number for your textile (ID#) and will verify yardage requirements for your order. Yardage requirements are based on directional, 54"-wide textiles. Additional yardage may be needed due to the unique characteristics of a textile.
3. Enter your order on Order Manager in Omni.
4. Upon receipt of your purchase order, Herman Miller will send you a PO acknowledgment.
5. Arrangements must be made for the textiles to be shipped from the supplier to Herman Miller for application to the seating products. See Omni for shipping procedures and current shipping addresses or contact a COM representative at (616) 654 3400 or (866) 854 3048 EXT 6543400.

Products will be scheduled for production when COM/COL textiles are received at Herman Miller. Standard lead times in effect at that time will apply.

Note: If textiles are to be purchased directly by Herman Miller through the Supplier Connection program, Herman Miller will handle the ordering and shipping process and will schedule your order for production upon receipt of your purchase order (dependent on textile availability). Refer to the Supplier Connection program for more information.

Supplier Connection

Program Overview

The Supplier Connection program is a service offered by Herman Miller to purchase approved COM textiles directly from True Textiles, C.F. Stinson, Luna Textiles, Maharam, and Momentum Textiles. When you select a textile through this program, Herman Miller will facilitate the ordering, scheduling, and shipment of the textile directly with the supplier.

Suppliers included in the Supplier Connection program keep an active inventory of textiles that are pre-approved for application to Herman Miller products. Pre-approval applies only to the suitability of a textile for manufacturing and application to a Herman Miller product. Omni provides an overview of fabrics that have been tested and indicates whether or not they were approved for application to Herman Miller products.

Specific information on the terms and conditions, testing, approval, and ordering process for the Supplier Connection program is listed below. Questions and requests for assistance may be directed to your COM representative at:

(616) 654 3400
(866) 854 3048 EXT 6543400

Supplier Connection Warranty

Textiles purchased by Herman Miller through the Supplier Connection program are COM and are not warranted by Herman Miller. COM textiles are tested for application only; they are not tested for performance. The Herman Miller warranty does apply to the underlying products.

Suppliers of COM textiles are responsible for color consistency within commercial tolerances, UV stability, and resistance to soiling and perspiration.

Customer's Own Material/ Customer's Own Leather Order Information — Cushion Tops

continued

Supplier Connection Pricing

Textiles purchased by Herman Miller through the Supplier Connection program are COM. COM is a Category 1 fabric. There are no application charges for COM fabrics.

Payment for textiles purchased by Herman Miller through the Supplier Connection program is the responsibility of the customer or dealer. Herman Miller will invoice the order at the supplier's prices published at the time of the order.

Textile Approval

1. Refer to Omni to identify the approval status of the textile. If your textile is not listed, contact the COM Department to request testing for application to Herman Miller products.
2. Herman Miller will notify you of approval or disapproval in approximately 4 days from receipt of the test yardage. If the textile is approved, it will be assigned a COM identification number.

Ordering Products with Supplier Connection COM

1. Identify and include the following information on your purchase order:
 - Product number and option
 - Herman Miller's COM identification number
2. Enter your order on Order Manager in Omni.
3. Upon receipt of the purchase order, Herman Miller will process your order and send you a PO acknowledgment. Herman Miller will determine the yardage required to produce your product and will order and schedule for delivery the required textile. Standard lead times in effect at the time the textile is allocated at the supplier will apply to products ordered through this program.



Customer's Own Material Order Information — Workspaces

Customer's Own Material

Program Overview

The Customer's Own Material (COM) program gives you the option of using textiles other than those listed. Herman Miller will test textiles for application to Herman Miller products and will process orders for those with approved COM textiles only. COM textiles are on assigned lead times.

Omni lists an overview of fabrics that have been tested and indicates whether or not they were approved for application to Herman Miller products.

Specific information on the terms and conditions, testing, approval, and ordering process for COM is listed below. Questions about the COM program and requests for assistance may be directed to your COM representative at:

(616) 654 3400

(866) 854 3048 EXT 6543400

Customer's Own Material Warranty

Herman Miller does not warrant COM textiles. COM textiles are tested for application only; they are not tested for performance. The Herman Miller warranty does apply to the underlying products.

Suppliers of COM textiles are responsible for color consistency within commercial tolerances, UV stability, and resistance to soiling and perspiration.

Customer's Own Material Pricing

COM is a Category 1 fabric. There are no application charges for COM fabrics.

Ordering and payment for COM textile yardage are the responsibility of the customer and the textile supplier.

If desired, Herman Miller will purchase COM textiles directly from True Textiles, C.F. Stinson, Luna Textiles, Maharam, and Momentum Textiles to simplify ordering and shipment. For this service, refer to the Supplier Connection program.

Application Note

Herman Miller does not guarantee that Customer's Own Material (COM) fabric patterns will align across panels/tiles or from one screen to the next. We also do not guarantee that COM fabric designs will be positioned consistently in the same location across several panels, tiles, or screens.

Textile Approval

1. Select a COM textile and a Herman Miller product.
2. If your textile is not listed in Omni, obtain a test number from a COM representative at (616) 654 3400. You can also submit your request within Omni. Please have the following information ready before calling: textile name, number, pattern, and the product you will apply it to.
3. Herman Miller will notify you of approval or disapproval within 4 days from receipt of the test yardage.

Ordering Products with COM

1. Refer to the specific products to determine the yardage required for COM textiles.
2. If your textile is not listed in Omni, call a COM representative at (616) 654 3400 or (866) 854 3048 EXT 6543400. The representative will assign an identification number for your textile (ID#) and will verify yardage requirements for your order.

Note: Yardage requirements are based on nondirectional, 54"-wide textiles. 66"-wide textiles are needed for application on 60"-wide products. Additional yardage may be needed due to the unique characteristics of a textile.

3. Enter your order on Order Manager in Omni.
4. Upon receipt of your purchase order, Herman Miller will send you a PO acknowledgment.
5. Arrangements must be made for the textiles to be shipped from the supplier to Herman Miller for application to the Herman Miller products. Textiles must be tagged with the assigned identification number and the roll yardage quantity. See Omni for shipping procedures and current shipping addresses or contact a COM representative at (616) 654 3400 or (866) 854 3048 EXT 6543400.

Products will be scheduled for production when COM textiles are received at Herman Miller. Standard lead times in effect at that time will apply.

Note: If textiles are to be purchased directly by Herman Miller through the Supplier Connection program, Herman Miller will handle the ordering and shipping process and will schedule your order for production upon receipt of your purchase order (dependent on textile availability). Refer to the Supplier Connection program for more information.

Customer's Own Material Order Information — Workspaces

continued

Supplier Connection

Program Overview

The Supplier Connection program is a service offered by Herman Miller to purchase approved COM textiles directly from True Textiles, C.F. Stinson, Luna Textiles, Maharam, and Momentum Textiles. When you select a textile through this program, Herman Miller will facilitate the ordering, scheduling, and shipment of the textile directly with the supplier.

Suppliers included in the Supplier Connection program keep an active inventory of textiles that are pre-approved for application to Herman Miller products. Pre-approval applies only to the suitability of a textile for manufacturing and application to a Herman Miller product. Omni provides an overview of fabrics that have been tested and indicates whether or not they were approved for application to Herman Miller products.

Specific information on the terms and conditions, testing, approval, and ordering process for the Supplier Connection program is listed below. Questions and requests for assistance may be directed to your COM representative at:

(616) 654 3400

(866) 854 3048 EXT 6543400

Supplier Connection Warranty

Textiles purchased by Herman Miller through the Supplier Connection program are COM and are not warranted by Herman Miller. COM textiles are tested for application only; they are not tested for performance. The Herman Miller warranty does apply to the underlying products.

Suppliers of COM textiles are responsible for color consistency within commercial tolerances, UV stability, and resistance to soiling and perspiration.

Supplier Connection Pricing

Textiles purchased by Herman Miller through the Supplier Connection program are COM. COM is a Category 1 fabric. There are no application charges for COM fabrics.

Payment for textiles purchased by Herman Miller through the Supplier Connection program is the responsibility of the customer or dealer. Herman Miller will invoice the order at the supplier's prices published at the time of the order.

Textile Approval

1. Refer to Omni to identify the approval status of the textile. If your textile is not listed, contact the COM Department to request testing for application to Herman Miller products.
2. Herman Miller will notify you of approval or disapproval in approximately 4 days from receipt of the test yardage. If the textile is approved, it will be assigned a COM identification number.

Ordering Products with Supplier Connection COM

1. Identify and include the following information on your purchase order:
 - Product number and option
 - Herman Miller's COM identification number
2. Enter your order on Order Manager in Omni.
3. Upon receipt of the purchase order, Herman Miller will process your order and send you a PO acknowledgment. Herman Miller will determine the yardage required to produce your product and will order and schedule for delivery the required textile. Standard lead times in effect at the time the textile is allocated at the supplier will apply to products ordered through this program.

Proprietary Textiles Application Chart — Workspaces

• Available

A Assigned lead-time textile.

See page 3 for exception notes.

	Action Office® Panels/Connectors	Action Office/Ethospace® B-Style Storage	Action Office B-Style Tackboards	Action Office/Ethospace E-Style Storage	Ethospace Tiles/Connectors	Ethospace Work Surface-Attached Screens	Ethospace/Canvas Office Landscape® Privacy Doors	Canvas Tiles/Extended Width Tiles	Canvas B-/E-Style Storage	Canvas Standing Screen and Team Wall Infill	Canvas Tackboards	Layout Studio® Framed Screen	Locale® Display Tackboard	Locale Freestanding Screen and Workbase Screen	Locale L-Desk/D-Desk Screens	Parl™ Screens/Flat Edge Screens	Prospect™ Exterior Acoustic Pad	Public Office Landscape® Screen/Desk Top Divider	Renew™ Link Screens	Resolve® Boundary Screens/Flags	Resolve Display Screens	Resolve Rolling Screens/Canopies	Exclave® Tackable Boards and Stowage Tackable Backdrop	Exclave Video-Friendly Tackable Boards and Stowage Tackable Backdrop	Intersect® Screens	Thrive® Personal Side Screen	Tu® Wood Storage Cubby Tackboard	5000 Series Storage and Tackboards	Seating
Price Category 1																													
COM Customer's Own Material A	1	1	1	1	1		1	1	1	1	•	1	1	1		1		1	1	1					1	1		3	1
8A__ Bubbletack™																													
2V__ Chain	•	•	•	•	•		•	22	•	•	•	•	•	•		•	•	•								•	•	3	
8T__ Crossing (85__)	2	2	2	•	•		•	•	2	•	•	•	•	•	•	•	•	•					•	8	•	•	•	3	18
3DE__ Dex	2	2	2	•	•		•	•	2	•	•	•	•	•	•	•	•	•					•		•	•	•	•	•
95__ Gem	2	2	2	•	•		•	•	2	•	•	•	•												•	•	•	3	•
2I__ Grasscloth	•	•	•	•	•		•	•	•	•	•	•	•	•	•	•	•	•							•	•	•	3	
1MN__ Monologue	2	2	2	•	•		•	•	2	•	•	•	•	•	•	•	•	•							•	•	•		•
8B__ Multiscrim™						•														•		•							
5T__ Resonance	•	•	•	•	•		•	•	•	•	•	•	•												•	•	•		
8C__ Scrim Trim																						•							
2M__ Silkworm	•	•	•	•	•		•	•	•	•	•	•	•												•	•	•	3	
22F__ Slant	6		•		•		•	•		•	•	•	•												•		•	3	
235__ Tailored A	•	•		•	•		•	8	•	•	•	•	•												•	•	•		•
1WS__ Whisper	2	2	2	•	•		•	•	2	•	•	•	•	•	•	•	•	•	•						•	•			•
Price Category 2																													
3AR__ Aristo	2	2	2	•	•		•	•	2	•	•	•	•	•	•	•	•	•					•		•	•	•		•
1CD__ Code	•	•	•	•	•		•	•	•	•	•	•	•										•		•				
3P__ ColorGuard		2		•																									•
51__ Cord	•	•	•	•	•		•	•	•	•	•	•	•												•		•	3	
92__ Crepe	2	•	•	•	•		•	•	•	•	•	•	•										•	8	•	•	•	3	•
3EP__ Epic	2	2	2	•	•		•	•	2	•	•	•	•	•	•	•	•	•					•		•	•	•		•
22Q__ Fish Net		2	2	•	•		•	•	2	•		•				•	•	•											•
57__ Frost	•	•	•	•	•		•	•	•	•	•	•	•	•		•		•	•						•	•	•	3	
84__ Grosgrain	4	•	•	•	•		•	8	•	•		•	19												•	19	•	3	
4N__ Horizon	2	2	2	•	•		•	•	•	•	•	•	•												•	•	•	3	
1LM__ Loom	2	2	2	•	•		•	•		•	•	•	•	•		•		•	•				•		•				•
1HA__ Medley	2	2	2	•	•		•	•	•	•	•	•	•	•	•	•	•	•					•	8	•	•			•
3A__ Moiré		2	2	•	•		•	22	2	•	•	•	•	•	•	•	•	•									•	3	•
1RV__ Rivet	2	2	2	•	•		•	•	2	•	•		•			•	•	•	•							•	•	•	•
8R__ Twist (5S__)	5	2	2	•	•		•	•	2	•	•	•	•	•	•	•	•	•	•						•	•	•	3	18
22T__ Well Suited		2		•	•		•	2	•																				•

continued on next page

Proprietary Textiles Application Chart — Workspaces

continued

	Action Office® Panels/Connectors	Action Office/Ethospace® B-Style Storage	Action Office B-Style Tackboards	Action Office/Ethospace E-Style Storage	Ethospace Tiles/Connectors	Ethospace Work Surface-Attached Screens	Ethospace/Canvas Office Landscape® Privacy Doors	Canvas Tiles/Extended Width Tiles	Canvas B-/E-Style Storage	Canvas Standing Screen and Team Wall Infill	Canvas Tackboards	Layout Studio® Framed Screen	Locale® Display Tackboard	Locale Freestanding Screen and Workbase Screen	Locale L-Desk/D-Desk Screens	Pari™ Screens/Flat Edge Screens	Prospect™ Exterior Acoustic Pad	Public Office Landscape® Screen/Desk Top Divider	Renew™ Link Screens	Resolve® Boundary Screens/Flags	Resolve Display Screens	Resolve Rolling Screens/Canopies	Exclave® Tackable Boards and Stowage Tackable Backdrop	Exclave Video-Friendly Tackable Boards and Stowage Tackable Backdrop	Intersect® Screens	Thrive® Personal Side Screen	Tu® Wood Storage Cubby Tackboard	5000 Series Storage and Tackboards	Seating		
Price Category 3																															
70__ Bento	2	2	2	•				•	2	•	•	•	•	•	•	•	•	•	•							•	•	•	•	•	
1FB_ Connection	•	•	•	•	•	•	•	•	•	•	•	•	•	•	•	•	•	•	•	•	•	•	•	•	•	•	•	•	•	•	
1FC_ Current	•	•	•	•	•	•	•	•	•	•	•	•	•	•	•	•	•	•	•	•	•	•	•	•	•	•	•	•	•	•	
8Z__ Glaze	•	•	•	•	•	•	•	•	•	•	•	•	•	•	•	•	•	•	•	•	•	•	•	•	•	•	•	•	•	•	
47__ Ground Cloth®	•	•	•	•	•	•	•	•	•	•	•	•	•	•	•	•	•	•	•	•	14			•	8	•	•	•	•	•	
5D__ Kira 2	2	2	2	•	•	•	•	•	2	•	•	•	•	•	•	•	•	•	•	•	14					•	•	•	•	•	
22R__ Pins and Needles	2	2	•	•	•	•	•	•	2	•	•	•	•	•	•	•	•	•	•	•	•	•	•	•	•	•	•	•	•	•	
8L__ Savannah	•	20	•	•	•	•	•	•	•	•	•	•	•	•	•	•	•	•	•	•	14					•	•	•	•	•	
8U__ Stitches (5Z__)	2	2	2	•	•	•	•	•	2	•	•	•	•	•	•	•	•	•	•	•	•	•	•	•	•	•	•	•	•	•	
8W__ Strands	•	•	•	•	•	•	•	•	•	•	•	•	•	•	•	•	•	•	•	•	•	•	•	•	•	•	•	•	•	•	
22V__ String Plaid	2	2	2	•	•	•	•	•	2	•	•	•	•	•	•	•	•	•	•	•	•	•	•	•	•	•	•	•	•	•	
Price Category 4																															
2X__ Glisten	•	•	•	•	•	•	•	•	•	•	•	•	•	•	•	•	•	•	•	•	•	•	•	•	•	•	•	•	•	•	•
22L__ Loft A		2	2	•	•	•	•	•	2	•	•	•	•	•	•	•	•	•	•	•			•	8	•	•	•	•	•	•	
6S__ Quilty	2	2	2	•	•	•	•	•	2	•	•	•	•	•	•	•	•	•	•	•	•	•	•	•	•	•	•	•	•	•	
63__ Sironetta	•	•	•	•	•	•	•	•	•	•	•	•	•	•	•	•	•	•	•	•	•	•	•	•	•	•	•	•	•	•	•
Price Category 5																															
14A__ Hopsak	2	2	2	•	•	•	•	•	2	•	•	•	•	•	•	•	•	•	•	•	•	•	•	•	•	•	•	•	•	•	•
Price Category 6																															
No fabrics available at this time.																															

- 1 Refer to price book appendices and Omni for COM information.
- 2 Available on all products except 54" and 60" wide.
- 3 Fabric is railroaded for all widths.
- 4 Not available on Action Office (AO) acoustical panels.
- 5 (8R__), (8T__), (85__), and (5S__) not available on AO acoustical panels and not available on 54"- or 60"-wide products.
- 6 Not available on Action Office (AO) connectors, cable management, and spacers.
- 8 Available in select colors. See the "Proprietary Textile Colors — Workspaces" appendix.
- 14 Not available on Resolve flags.
- 18 Available on seating products in select colors. See the "Proprietary Textile Colors — Seating" appendix.
- 19 Not available in Grosgrain (84__) fabric colors 8401, 8405, and 8413.
- 20 Available only on Ethospace B-Style.
- 22 Not available as railroaded application option for Chain (2Voo) and Moiré (3Aoo) on Canvas Extended Width Tiles.
- 24 Not available on Ethospace cable access tile, cable channel tile, or beltline face tile.

Application Note: Herman Miller cannot guarantee material/pattern alignment in adjacent products. For example, a fabric's pattern may not align from one screen to the next, or from one panel to the next.

Proprietary Textile Colors — Workspaces

Price Category 1

Customer's Own Material
See Order Information in
Appendices.
Assigned lead-time textile. A

Bubbletack™	
100% polyester	
8A01	Seashell White
8A02	Pearl Grey
8A05	Dune Beige
8A07	Pebble Beige
8A09	Olive Green
8A13	Slate Purple
8A19	Spa Blue
8A24	Sable Grey
8A27	Summer White
8A28	Moth Grey
8A29	Tea Leaf Grey
8A30	Blue Grey
8A31	Dusty Bronze
8A32	Slate Blue
8A33	Caramel Beige
8A34	Kiwi Green
8A35	Studio White
8A36	Blush Grey
8A37	Shale
8A38	Slate
8A39	Eggnog
8A40	Persimmon
8A41	Bud

Chain	
66" wide	
100% recycled polyester	
2V01	Pearl
2V02	Oyster
2V03	Wheat
2V04	Linen
2V05	Wicker
2V06	Bamboo
2V07	Sage
2V08	Spring Wood
2V09	Iceberg

Crossing	
54" wide	
86% antimony-free polyester	
14% polyester	
8T03	Wicker *
8T04	Porcelain *
8T05	Warm Grey *
8T06	Sepia
8T07	Pumpkin
8T08	Copper
8T09	Cranberry
8T10	Tomato
8T11	Mulberry
8T12	Plum
8T13	Green Apple
8T14	Loden
8T15	Spruce
8T16	Periwinkle
8T17	Cerulean
8T18	Indigo
8T19	Shale *
8T20	Brownstone
8T21	Bark
8T22	Tin *
8T23	Graphite
8T24	Black

Crossing	
For workspaces products only.	
54" wide	
86% antimony-free polyester	
14% polyester	
8501	Ivory *
8502	Oyster *

* Colors available on Exclave®
Video-friendly Tackable
Boards and Stowage Tackable
Backdrop

Dex	
54" wide	
50% recycled polyester	
50% polyester	
3DE01	Frost
3DE02	Silver Pine
3DE03	Stone
3DE04	Shale
3DE05	Charcoal

Gem	
54" wide	
100% antimony-free polyester	
9501	Sesame
9502	Tangerine
9503	Red
9504	Red Violet
9505	Mulberry
9506	Java
9507	Twilight
9508	Bayou
9509	Iris
9510	Berry Blue
9511	Aqua Green
9512	Green Apple
9513	Spruce
9514	Black
9515	Slate Grey
9516	Fog

Grasscloth	
66" wide	
100% recycled polyester	
2I01	Silver Birch
2I02	Pampas
2I03	Sedge
2I07	Lea
2I08	Taro
2I09	Steam Grey
2I10	Cayenne
2I11	Bottle Green
2I12	Surf
2I13	Gravel

Monologue	
54" wide	
56% recycled polyester	
44% polyester	
1MN01	Linen
1MN02	Alabaster
1MN03	Truffle
1MN04	Folkstone
1MN05	Silver Pine
1MN06	Slate
1MN07	Seed
1MN08	Yellow Oxide
1MN09	Persimmon
1MN10	Tundra
1MN11	Meadow
1MN12	Blue Sky
1MN13	Blue Spruce
1MN14	Deep Sea

Multiscrim™	
60" wide	
100% polyester	
8B01	Seashell White
8B02	Pearl Grey
8B05	Dune Beige
8B07	Pebble Beige
8B09	Olive Green
8B15	Slate Purple
8B19	Spa Blue
8B24	Sable Grey
8B27	Summer White
8B28	Moth Grey
8B29	Tea Leaf Grey
8B30	Blue Grey
8B31	Dusty Bronze
8B32	Slate Blue
8B33	Caramel Beige
8B34	Kiwi Green
8B35	Studio White
8B36	Blush Grey
8B37	Shale
8B38	Slate
8B39	Eggnog
8B40	Persimmon
8B41	Bud

Price category 1 continued on
next page

Proprietary Textile Colors — Workspaces

continued

Price Category 1

continued

Resonance

66" wide	
100% polyester	
5T04	Greige
5T05	Porcelain
5T06	Alabaster
5T15	Iris
5T28	Sugar
5T47	Tobacco
5T54	Saltbush
5T57	Seed
5T58	Sepia
5T59	Tundra
5T60	Iceberg
5T61	Black
5T62	Chamois
5T63	Citrus
5T64	Tangerine
5T65	Red
5T66	Wild Berry
5T67	Boysenberry
5T68	Pistachio
5T69	Green Apple
5T70	Forest
5T71	Jade
5T72	Blue Green
5T73	Bright Turquoise
5T74	Twilight

Scrim Trim

61" wide	
82% polyester	
18% spandex	
8C01	Seashell White
8C02	earl Grey
8C22	Winter Grey
8C24	Sable Grey

Silkworm

66" wide	
58% recycled polyester	
42% polyester	
2M01	Cocoon
2M02	Pongee
2M03	Saffron
2M04	Tussah
2M05	Ceylon
2M06	Jasmine
2M07	Shale
2M08	Monsoon

Slant

66" wide	
51% polyester	
49% recycled polyester	
22F01	Beech Nut
22F02	Chamois
22F03	Chartreuse
22F04	Pesto
22F05	Peacock
22F06	Neptune
22F07	Blueberry
22F08	Boysenberry
22F09	Magenta
22F10	Pumpkin
22F11	Cranberry
22F12	Silver Birch
22F13	Bluestone
22F14	Truffle
22F15	Shale

Tailored

Assigned lead-time textile. A	
54" wide	
56% polyester	
44% recycled polyester	
23501	Studio White *
23502	Sugar
23503	Tomato
23504	Orchid
23505	Boysenberry
23506	Chive
23507	Bluegrass
23508	Cobalt
23509	Cadet
23510	Fog
23511	Graphite
23512	Black
23513	Coffee

* Color not available on Canvas Tiles.

Whisper

54" wide	
73% recycled polyester	
27% polyester	
1WS01	Sand Dollar
1WS02	Pebble
1WS03	Silver Birch
1WS04	Iceberg
1WS05	Silver Pine
1WS06	Carbon
1WS07	Cumin
1WS08	Adobe
1WS09	Strawberry
1WS10	Blush
1WS11	Eggplant
1WS12	Willow
1WS13	Sea Grass
1WS14	Pool
1WS15	Blueberry

Price Category 2

Aristo

54" wide	
88% recycled polyester	
12% polyester	
Acrylic backing	
3AR01	Forest Moss
3AR02	Light Brindle
3AR03	Mink
3AR04	Copper
3AR05	Adobe
3AR06	Cherry
3AR07	Lilac
3AR08	Green Apple
3AR09	Surf
3AR10	Waterfall
3AR11	Cadet
3AR12	Tin
3AR13	Pewter
3AR14	Grey Brindle
3AR15	Grey Black

Code

66" wide	
100% Repreve recycled polyester	
1CD01	Linen
1CD02	Khaki
1CD03	Iceberg
1CD04	Zinc
1CD05	Blue Black

Price category 2 continued on next page

Proprietary Textile Colors — Workspaces

continued

Price Category 2

continued

ColorGuard	
54" wide	
100% vinyl	
3P01	Grey
3P02	Navy
3P03	Spruce A
3P08	Blueberry A
3P12	Black Plum A
3P14	Black
3P19	Slate
3P31	Horizon Blue A
3P33	Pumice
3P54	Candy Apple A
3P72	Allspice A
3P96	Manzanita A
3P97	Fudge A
3PB2	Sea Grass A
3PB5	Vizcaya Palm A
3PB9	Neptune A
3PC7	Bucksuede A
3PD4	Otter A

A Assigned lead-time color.

Cord	
66" wide	
51% antimony-free polyester	
49% polyester	
5101	Ivory
5102	White Ash
5103	Linen
5104	Bamboo
5105	Sepia
5106	Wicker
5107	Sesame
5108	Kiwi Green
5109	Bayou
5110	Shade
5111	Spring Wood
5112	Summer White

Crepe	
54" wide	
100% recycled polyester	
9201	Licorice
9203	Smoke
9207	Cherry
9209	Claret
9212	Raisin
9218	Aquamarine
9223	Cadet
9241	Beachglass
9243	Midnight
9244	Artichoke
9248	Warm White *
9249	Stone *
9250	Earth
9251	Fog *
9252	Slate Grey
9253	Yellow Dark
9254	Coral
9255	Blush Grey *
9256	Wild Berry
9257	Clover
9258	Caribbean
9259	Cerulean
9260	Brownstone
9261	Shale
9262	Graphite
9263	Tomato
9264	Green Apple

* Colors available on Exclave® Video-friendly Tackable Boards and Stowage Tackable Backdrop.

Epic	
54" wide	
56% recycled polyester	
44% polyester	
Acrylic backing	
3EP01	Alabaster
3EP02	Smoke
3EP03	Falcon
3EP04	Citrus Spring
3EP05	Copper
3EP06	Urban Orange
3EP07	Poppy
3EP08	Wild Plum
3EP09	Sugar Plum
3EP10	Clover
3EP11	Loden
3EP12	Everglade
3EP13	Mist
3EP14	Peacock
3EP15	Cadet
3EP16	Indigo
3EP17	Spring Wood
3EP18	Grey Brindle
3EP19	Seed
3EP20	Carbon Dark

Fish Net	
55" wide	
100% recycled polyester	
22Q01	Oyster
22Q02	Stone
22Q03	Citrus
22Q04	Curry
22Q05	Chipotle
22Q06	Cherry
22Q07	Fuschia
22Q08	Claret
22Q09	Purple
22Q10	Clover
22Q11	Pesto
22Q12	Peacock
22Q13	Lagoon
22Q14	Twilight
22Q15	Bluestone
22Q16	Storm
22Q17	Black
22Q18	Cocoa

Frost	
66" wide	
100% recycled polyester	
5701	Bisque
5702	Abalone
5703	Porcelain
5704	Honey
5705	Iceberg
5706	Sage
5707	Reed
5708	Steam Grey
5709	Gunmetal
5710	Sable Grey

Grosgrain	
66" wide	
100% recycled polyester	
8401	Pearl * **
8402	White Ash
8403	Warm Grey
8404	Khaki
8405	Oyster *
8406	Celadon
8408	Spa Blue
8409	Bud
8410	Kiwi Green
8411	Bayou
8412	Tin
8413	Iceberg *

* Colors not available on Canvas Dock Mounted Screens, Locale® Workbase Screen, Public Office Landscape® Screen/Desk Top Divider, and Thrive® Personal Side Screen.

** Color not available on Canvas Tiles.

Price category 2 continued on next page

Proprietary Textile Colors — Workspaces

continued

Price Category 2

continued

Horizon

54" wide	
65% antimony-free polyester	
35% polyester	
4N01	Rye Grass
4N02	Sugar Pine
4N03	Silver Pine
4N04	White Ash
4N05	Spring Wood
4N06	Tamarack
4N07	Mushroom
4N08	Haystack
4N09	Oat Grass
4N10	Forest Moss
4N11	Hickory
4N12	Beech Nut
4N13	Pine Cone
4N14	Poplar
4N15	Elderberry

Loom

54" wide	
100% polyester	
1LM01	Linen
1LM02	Brown Sugar and Spice
1LM03	Brick and Mortar
1LM04	Salt and Pepper
1LM05	Black
1LM06	Lemongrass
1LM07	Poppy
1LM08	Wild Berry
1LM09	Loden
1LM10	Jade
1LM11	Deep Sea

Medley

54" wide	
100% polyester	
1HA01	Stone *
1HA02	Trail
1HA03	Charcoal
1HA04	Cinder
1HA05	Citrus
1HA06	Papaya
1HA07	Chutney
1HA08	Tundra
1HA09	Feather Grey *
1HA10	Chartreuse
1HA11	Loden
1HA12	Peacock
1HA13	Bayou *
1HA14	Blue Grotto
1HA15	Blueberry
1HA22	Khaki
1HA23	Pewter
1HA24	Yellow Oxide
1HA25	Vintage Rose
1HA26	Raspberry
1HA27	Acai Berry

* Colors available on Exclave®
Video-friendly Tackable
Boards and Stowage Tackable
Backdrop

Moiré

54" wide	
100% recycled polyester	
3A01	Concrete
3A02	Biscotti
3A03	Rattan
3A04	Chambray
3A05	Fern
3A08	Violet
3A09	Zin
3A10	Curry
3A11	Spice
3A12	Cork

Rivet

54" wide	
100% recycled polyester	
1RV01	Twig
1RV02	Deep Clay
1RV03	Woodrose
1RV04	Otter
1RV05	Hemlock
1RV06	Olive
1RV07	Lagoon
1RV08	Deep Sea
1RV09	Charcoal
1RV10	Grey Brindle

Twist

54" wide	
80% antimony-free polyester	
13% recycled polyester	
7% polyester	
8R05	Wicker
8R10	Poppy
8R14	Tin
8R15	Shale
8R16	Graphite
8R17	Birch
8R18	Sepia
8R22	Blueberry
8R23	Green Apple
8R26	Gunmetal
8R27	Cinder
8R28	Citrus
8R29	Pekoe
8R30	Tangerine
8R31	Red Plum
8R32	Wisteria
8R33	Forest
8R34	Jade Dark
8R35	Waterfall
8R36	Midnight Blue
8R37	arbon Dark

Twist

For workspaces products only.	
54" wide	
80% antimony-free polyester	
13% recycled polyester	
7% polyester	
5S01	Pearl
5S02	Ivory
5S03	Oyster

Price category 2 continued on next page

Proprietary Textile Colors — Workspaces

continued

Price Category 2

continued

Well Suited	
55" wide	
79% polyester	
21% recycled polyester	
22T01	Oyster
22T02	Raffia
22T03	Peppermint
22T04	Wild Berry
22T05	Spring Green
22T06	Mint
22T07	Periwinkle
22T08	Cool Grey
22T09	Citrus
22T10	Pumpkin
22T11	Red
22T12	Fuschia
22T13	Orchid
22T14	Chartreuse
22T15	Green Apple
22T16	Jade
22T17	Peacock
22T18	Blueberry
22T19	Bluestone
22T20	Mink

Price Category 3

Bento	
54" wide	
100% antimony-free polyester	
7001	Frost
7002	Linen
7003	Khaki
7004	Truffle
7005	Grey Black
7006	Pumpkin
7007	Cranberry
7008	Everglade
7009	Cobalt

Connection	
66" wide	
100% antimony-free polyester	
1FB1	Oyster
1FB2	Linen
1FB3	Iceberg
1FB4	Silver Pine
1FB5	Apricot
1FB6	Cumin
1FB7	Green Apple
1FB8	Slate Blue
1FB9	Metal

Current	
66" wide	
100% antimony-free polyester	
1FC1	Oyster
1FC2	Linen
1FC3	Iceberg
1FC4	Silver Pine
1FC5	Apricot
1FC6	Cumin
1FC7	Green Apple
1FC8	Slate Blue
1FC9	Metal

Glaze	
66" wide	
100% recycled polyester	
8Z01	Wicker
8Z02	Honey
8Z03	Porcelain
8Z04	Celadon
8Z06	Rye
8Z07	Frost
8Z08	Silver Birch

Ground Cloth®	
66" wide	
100% polyester	
4701	Vapor Grey
4721	Warm White *
4722	Fog *
4723	Straw *
4724	Red Orange *
4725	Wild Berry *
4726	Green Apple *
4727	Caribbean *
4728	Midnight *
4729	Cappuccino *

* Colors available on Exclave®
Video-friendly Tackable
Boards and Stowage Tackable
Backdrop

Kira 2	
54" wide	
100% recycled polyester	
5D11	Flaxen
5D12	Papyrus
5D13	Oasis
5D14	Incense
5D15	Ash
5D16	Falcon

Pins and Needles	
58" wide	
76% recycled polyester	
24% polyester	
22R01	Day and Night
22R02	Night and Day

Savannah	
66" wide	
76% recycled polyester	
24% polypropylene	
8L01	Pearl
8L02	Oyster
8L03	Wheat
8L04	Jute
8L05	Bamboo
8L06	Metal
8L07	Linen
8L08	Celadon
8L09	Moss
8L10	Frost
8L11	Shale
8L12	Pewter

Stitches	
54" wide	
54% polyester	
46% recycled polyester	
8U02	Rye
8U03	Khaki
8U04	Honey
8U05	Cattail
8U08	Cool Grey
8U09	Slate Blue
8U11	Evening Blue
8U12	Charcoal
8U13	Kiwi Green
8U16	Cocoa
8U17	Seed

Stitches	
For workspaces products only.	
54" wide	
54% polyester	
46% recycled polyester	
5Z01	White Ash

Price category 3 continued on next page

Proprietary Textile Colors — Workspaces

continued

Price Category 3

continued

Strands	
66" wide	
100% recycled polyester	
8W01	Pebble
8W02	Porcelain
8W03	Taupe
8W04	Honey
8W05	Khaki
8W06	Rye
8W07	Wicker
8W08	Tin
8W09	Cool Grey
String Plaid	
54" wide	
100% recycled polyester	
22V01	Warm White on Khaki
22V02	Mint on Yellow Green
22V03	Mist on Blue Grey
22V04	Sky Blue on Red
22V05	Lime on Magenta
22V06	Bright Green on Green
22V07	Aqua Blue on
Cerulean	
22V08	Ivory on Black

Price Category 4

Glisten	
66" wide	
84% polyester	
16% recycled polyester	
2X02	Rye
2X05	Iceberg
2X09	Pewter
2X10	Ash
Loft	
Assigned lead-time textile. A	
54" wide	
100% wool	
22L01	Heathered Light Green
22L02	Heathered Dark Green
22L03	Heathered Turquoise
22L04	Heathered Navy
22L05	Heathered Orange
22L06	Heathered Red
22L07	Heathered Tan *
22L08	Heathered Grey *
22L09	Heathered Blue *
22L10	Heathered Brown
22L11	Heathered Dark Grey
22L12	Heathered Denim

* Colors available on Exclave®
 Video-friendly Tackable
 Boards and Stowage Tackable
 Backdrop

Price Category 5

Quilty	
56" wide	
100% antimony-free polyester	
GreenShield	
6S03	Khaki
6S04	Straw
6S07	Brick
6S10	Mink
6S11	Green Apple
6S13	Indigo
6S14	Zinc
6S15	Slate
6S16	Beachwood
6S17	Paprika
6S18	Plum
6S19	Juniper
6S20	Grey Black
Sironetta	
66" wide	
100% recycled polyester	
6301	Acapella
6302	Sonata
6303	Interlude
6304	Legato
6308	Harmony
6309	Ensemble

Hopsak	
56" wide	
100% recycled polyester	
14A20	Black
14A22	Raw Umber Dark
14A26	Grey Blue Dark
14A30	Sepia Dark
14A38	Emerald Dark
14A39	Yellow Dark
14A40	Orange
14A41	Sienna
14A42	Olive Green Dark
14A43	Crimson
14A44	Crimson Dark Dark
14A45	Violet Dark
14A46	Pink Dark Dark
14A47	Ultramarine Dark
14A48	Cobalt Blue
14A49	Terra Cotta
14A50	Ochre Dark

Maharam® Application Chart — Workspaces

•Available

See below for exception notes.

Maharam textiles are on assigned lead times. A

	Action Office® Panels/Connectors	Action Office/Ethospace® B-Style Storage	Action Office/Ethospace B-Style Tackboards	Action Office/Ethospace E-Style Storage	Ethospace Tiles/Connectors	Ethospace/Canvas Office Landscape® Privacy Doors	Canvas Tiles/Extended Width Tiles	Canvas B-/E-Style Storage	Canvas Tackboards	Locale® Freestanding Screen and Workbase Screen	Pari™ Screens/Flat Edge Screens	Prospect™ Exterior Acoustic Pad	Public Office Landscape® Screen/Desk Top Divider	Renew™ Link Screens	Resolve® Boundary Screens/Flags	Resolve Display Screens	Resolve Rolling Screens/Canopies	Intersect® Screens	Thrive™ Personal Side Screen	5000 Series Storage	5000 Series Tackboards	Seating	
Price Category 1-2																							
No fabrics available at this time.																							
Price Category 3																							
ZM2__Meld - Maharam	2	2	2	•	•	•	•	•	•	•	•	•	•	•					•	•			
Price Category 4-9																							
No fabrics available at this time.																							
Price Category A																							
No fabrics available at this time.																							
Price Category B																							
VQ__Crisp - Maharam	5	•	•	•	12		•	•	•										•		3	3	
VM__Medium - Maharam		2	2				•	20	•										•		3	•	
TI__Messenger - Maharam *		2	2	•	12	•	•	2	•		•									3	3	•	
Price Category C																							
Z27__Manner - Maharam	2	2	2	2	•		•	2	•		•										3	3	•
Z3__Metric - Maharam		2	2			•	•		•										•		3	3	•
TT__Parallel - Maharam	7	•	•		•	•	•	18	•									•			3		•
Price Category D																							
ZMD__Mode - Maharam	2																						•
Z2R__Reply - Maharam	•	•	•	•		•	•											•			3		
ZS3__Spiral - Maharam	•	•	•	•	•		•	•	•														
Z34__Unit - Maharam	•						•		•												3	3	
Price Category E																							
ZF3__Flock - Maharam										•	•		•	•									
ZGT__Glint - Maharam	2	2	2	2	2		•	2	•														
Z25__Hum - Maharam	11	2		2	•		•	2													3		
ZM1__Morse - Maharam	•	•	•	•	•		•	•	•														
Z32__Skein - Maharam	2	2	2	2	•		•	2	•												3	3	•
ZSC__Sketch - Maharam	•	•	•	•	•		•	•	•														
Price Category F																							
ZA1__Adjourn - Maharam	•	•	•	•	•			•	•														
VS__Crush - Maharam			2	•				19										•			3	3	•
Z29__Plait - Maharam	2	2	2	2	•		•	2	•												3	3	•
ZS2__Sharkskin 2 - Maharam	2	2	2	2	2		•	2	•														
Price Category G																							
ZT4__Ticker - Maharam	2	2	2	2	2		•	2	•														•
Price Category H-Z																							
No fabrics available at this time.																							

* Available in select colors on 20-day lead-time. Refer to “Maharam Colors - Workspaces” for 20-day colors.

2 Available on all products except 54” and 60” wide.

3 Fabric is railroaded for all widths.

5 Not available on AO partial-glazed panels.

7 Not available on AO acoustical panels; not available on AO2 cable management panel face.

11 Available on AO products except 54” wide and 60” wide; not available on AO connectors.

12 Not available on Ethospace tackable tiles.

18 Not available on Canvas E-style storage.

19 Not available on Canvas B-style storage.

20 Not available on Canvas E-style storage or 60”-wide B-style storage.

Application Note: Herman Miller cannot guarantee material/pattern alignment in adjacent products. For example, a fabric’s pattern may not align from one screen to the next, or from one panel to the next.



Maharam® Colors — Workspaces

Price Category 1-2

No fabrics available at this time.

Price Category 3

Meld – Maharam

54" wide
 68% post-consumer recycled polyester
 32% polyester
 PFOA-Free stain resistant

ZM201/466387-201 Vast
 ZM202/466387-202 Panda
 ZM203/466387-203 Skyline
 ZM204/466387-204 Knight
 ZM205/466387-205 Quill
 ZM206/466387-206 Pipe
 ZM207/466387-207 Grate
 ZM208/466387-208 Gloss
 ZM209/466387-209 Bulb
 ZM210/466387-210 Bride
 ZM211/466387-211 Stark
 ZM212/466387-212 Seashell
 ZM213/466387-213 Antler
 ZM214/466387-214 Crater
 ZM215/466387-215 Perennial
 ZM216/466387-216 Mulberry
 ZM217/466387-217 Fuchsia
 ZM218/466387-218 Amethyst
 ZM219/466387-219 Merlot
 ZM220/466387-220 Magma
 ZM221/466387-221 Rooster
 ZM222/466387-222 Heat
 ZM223/466387-223 Clementine
 ZM224/466387-224 Fox
 ZM225/466387-225 Kiss
 ZM226/466387-226 Bare
 ZM227/466387-227 Blonde
 ZM228/466387-228 Mimosa
 ZM229/466387-229 Comet
 ZM230/466387-230 Honeydew
 ZM231/466387-231 Wild
 ZM232/466387-232 Vine
 ZM233/466387-233 Seed
 ZM234/466387-234 Kale

Meld continued

ZM235/466387-235 Waterfall
 ZM236/466387-236 Nordic
 ZM237/466387-237 Reef
 ZM238/466387-238 Wave
 ZM239/466387-239 Isle
 ZM240/466387-240 Creek
 ZM241/466387-241 Mariner
 ZM242/466387-242 Globe
 ZM243/466387-243 Spa

Price Category 4-9

No fabrics available at this time.

- Maharam textiles are on assigned lead times [A](#).
- Fabric numbers are listed as Herman Miller fabric number/Maharam fabric number.

Price Category A

Price Category B

No fabrics available at this time.

Crisp – Maharam

66" wide

100% polyester

VQ02/901420-002	Oyster
VQ05/901420-005	Quahaug
VQ13/901420-013	Admiral
VQ14/901420-014	Thunder
VQ21/901420-021	Graphite
VQ22/901420-022	Lychee
VQ23/901420-023	Persimmon
VQ24/901420-024	Kimchi
VQ25/901420-025	Marigold
VQ26/901420-026	Brut
VQ27/901420-027	Chartreuse
VQ28/901420-028	Celadon
VQ29/901420-029	Surf
VQ30/901420-030	Marble
VQ31/901420-031	Boulder
VQ32/901420-032	Bell
VQ33/901420-033	Ferry
VQ34/901420-034	Sapphire
VQ35/901420-035	Carbon
VQ36/901420-036	Owl
VQ37/901420-037	Agate

Medium – Maharam

54" wide

100% polyester

VM01/463490-001	Raven
VM02/463490-002	Smoke
VM03/463490-003	Alloy
VM04/463490-004	Flax
VM06/463490-006	Bark
VM07/463490-007	Espresso
VM08/463490-008	Pecan
VM12/463490-012	Pumpkin
VM13/463490-013	Persimmon
VM14/463490-014	Laser
VM16/463490-016	Port
VM22/463490-022	Marina
VM29/463490-029	Pistachio
VM32/463490-032	Prospect
VM36/463490-036	Delight
VM39/463490-039	Nautical
VM40/463490-040	Pool
VM44/463490-044	Washed
VM45/463490-045	Sculpture
VM46/463490-046	Thatched
VM47/463490-047	Hike
VM48/463490-048	Tangle
VM49/463490-049	Pacific
VM50/463490-050	Cosmic
VM51/463490-051	Cascade
VM52/463490-052	Blackberry
VM53/463490-053	Nasturtium
VM54/463490-054	Wooded

Messenger – Maharam

54" wide

78% recycled polyester

15% polyester, 7% nylon

TI01/458640-001	Balsa
TI06/458640-006	Tobacco
TI07/458640-007	Shadow *
TI08/458640-008	Bayou *
TI10/458640-010	Zinc
TI24/458640-024	Poppy

Messenger continued

TI25/458640-025	Mao
TI29/458640-029	Onyx
TI31/458640-031	Cloud *
TI38/458640-038	Depth *
TI40/458640-040	Nile
TI41/458640-041	Azure *
TI45/458640-045	Cactus *
TI46/458640-046	Ice *
TI48/458640-048	Neon *
TI50/458640-050	Hydrangea *
TI51/458640-051	Lilac
TI52/458640-052	Chestnut
TI53/458640-053	Tangelo
TI54/458640-054	Lumine *
TI58/458640-058	Snow
TI59/458640-059	Fennel
TI60/458640-060	Peridot *
TI61/458640-061	Capri
TI62/458640-062	Ultramarine
TI63/458640-063	Squall
TI66/458640-066	Cassis
TI67/458640-067	Aster
TI68/458640-068	Spice
TI69/458640-069	Cherry
TI70/458640-070	Vibrant
TI71/458640-071	Satsuma *
TI72/458640-072	Maize
TI76/458640-076	Fossil
TI77/458640-077	Ash
TI78/458640-078	Tusk
TI79/458640-079	Oyster
TI80/458640-080	Pensive
TI81/458640-081	Husk
TI82/458640-082	Fireside
TI83/458640-083	Chili
TI84/458640-084	Robust
TI85/458640-085	Beyond
TI86/458640-086	Voyage
TI87/458640-087	Everglade
TI88/458640-088	Electric

* Colors available on
20-day lead time.

- Maharam textiles are on assigned lead times [\[A\]](#).
- Fabric numbers are listed as Herman Miller fabric number/Maharam fabric number.

Maharam® Colors — Workspaces

continued

Price Category C

Manner - Maharam	
54" wide	
100% recycled polyester	
Z2701/466177-001	Magic
Z2702/466177-002	Carob
Z2703/466177-003	Porpoise
Z2704/466177-004	Flint
Z2705/466177-005	Hush
Z2706/466177-006	Nuance
Z2707/466177-007	Thicket
Z2708/466177-008	Cocoa
Z2709/466177-009	Pathway
Z2710/466177-010	Cola
Z2711/466177-011	Ember
Z2712/466177-012	Wagon
Z2713/466177-013	Ablaze
Z2714/466177-014	Peel
Z2715/466177-015	Penny
Z2716/466177-016	Butterscotch
Z2717/466177-017	Harvest
Z2718/466177-018	Lioness
Z2719/466177-019	Caper
Z2720/466177-020	Parakeet
Z2721/466177-021	Greenway
Z2722/466177-022	Aquatic
Z2723/466177-023	Cottage
Z2724/466177-024	Dahlia
Z2725/466177-025	Vivid
Z2726/466177-026	Basin
Z2727/466177-027	Schooner

Metric – Maharam	
54" wide	
51% recycled polyester	
49% polyester	
Z301/466014-001	Phantom
Z302/466014-002	Fog
Z303/466014-003	Fleece
Z304/466014-004	Sourdough
Z305/466014-005	Toffee
Z306/466014-006	Driftwood
Z307/466014-007	Mineral
Z308/466014-008	Bittersweet
Z309/466014-009	Arabica
Z310/466014-010	Cerise
Z311/466014-011	Brick
Z312/466014-012	Cardinal
Z313/466014-013	Lava
Z314/466014-014	Oriole
Z315/466014-015	Cedar
Z317/466014-017	Caramel
Z318/466014-018	Pollen
Z319/466014-019	Tupelo
Z320/466014-020	Alligator
Z321/466014-021	Envy
Z322/466014-022	Bonsai
Z323/466014-023	Tar
Z324/466014-024	Anchor
Z325/466014-025	Twilight
Z326/466014-026	Admiral
Z327/466014-027	Seaport
Z328/466014-028	Scuba

Parallel — Maharam	
66" wide	
100% recycled polyester	
TT01/901180-001	Chalk
TT02/901180-002	Argent
TT03/901180-003	Fog
TT11/901180-011	Cadet
TT17/901180-017	Sourdough
TT22/901180-022	Sterling
TT23/901180-023	Linen
TT24/901180-024	Pea

Price Category D

Mode – Maharam	
54" wide	
80% post-consumer recycled polyester	
20% polyester	
PFOA-Free stain resistant finish	
ZMD01/466337-001	Stroll
ZMD02/466337-002	Intaglio
ZMD03/466337-003	Ominous
ZMD04/466337-004	Machine
ZMD05/466337-005	Talus
ZMD06/466337-006	Marsh
ZMD07/466337-007	Hollow
ZMD08/466337-008	Sycamore
ZMD09/466337-009	Clavicle
ZMD10/466337-010	Billygoat
ZMD11/466337-011	Spindle
ZMD12/466337-012	Lemon
ZMD13/466337-013	Oxeye
ZMD14/466337-014	Henge
ZMD15/466337-015	Goldenrod
ZMD16/466337-016	Cottontail
ZMD17/466337-017	Lioness
ZMD18/466337-018	Oriole
ZMD19/466337-019	Rust
ZMD20/466337-020	Carotene
ZMD21/466337-021	Blush
ZMD22/466337-022	Vermilion
ZMD23/466337-023	Alder
ZMD24/466337-024	Kermes
ZMD25/466337-025	Barberry
ZMD26/466337-026	Petal
ZMD27/466337-027	Valley
ZMD28/466337-028	Odyssey
ZMD29/466337-029	Ballpoint
ZMD30/466337-030	Toile
ZMD31/466337-031	Paradise
ZMD32/466337-032	Angelfish
ZMD33/466337-033	Denim
ZMD34/466337-034	Crush
ZMD35/466337-035	Jetty
ZMD36/466337-036	Saltwater
ZMD37/466337-037	Mallard
ZMD38/466337-038	Celtic

Mode continued	
ZMD39/466337-039	Eucalyptus
ZMD40/466337-040	Bonsai
ZMD41/466337-041	Sassafras
ZMD42/466337-042	Yucca
ZMD43/466337-043	Lichen

Reply - Maharam	
66" wide	
100% polyester	
Z2R1/901880-001	Canvas
Z2R5/901880-005	Pewter
Z2R6/901880-006	Lapis
Z2RB/901880-011	Adobe
Z2RD/901880-013	Beacon

Spiral - Maharam	
66" wide	
100% polyester	
ZS301/901882-001	Chalk
ZS302/901882-002	Birch
ZS303/901882-003	Wheat
ZS304/901882-004	Mica
ZS305/901882-005	Pavement
ZS306/901882-006	Graphite

Unit - Maharam	
66" wide	
100% recycled polyester	
Z3401/901889-001	Seawall
Z3402/901889-002	Limestone
Z3403/901889-003	Aluminum
Z3404/901889-004	Snow
Z3405/901889-005	Tusk
Z3406/901889-006	Nautilus
Z3407/901889-007	Beech
Z3408/901889-008	Driftwood
Z3409/901889-009	Cocoa

- Maharam textiles are on assigned lead times [A](#).
- Fabric numbers are listed as Herman Miller fabric number/Maharam fabric number.

Price Category E

Flock - Maharam	
63" wide	
100% polyester	
ZF301/901892-001	Calm
ZF302/901892-002	Course
ZF303/901892-003	Highlight
ZF304/901892-004	Roe
ZF305/901892-005	Poppy
ZF306/901892-006	Briefcase
ZF307/901892-007	Monkstrap
ZF308/901892-008	Quag
ZF309/901892-009	Pistachio
ZF310/901892-010	Froth
ZF311/901892-011	Celadon
ZF312/901892-012	Highsea
ZF313/901892-013	China
ZF314/901892-014	Victorian
ZF315/901892-015	Commmander
ZF316/901892-016	Raven
ZF317/901892-017	Aluminum

Glint - Maharam	
54" wide	
59% polyolefin	
32% post-industrial recycled polyester	
9% post-consumer recycled polyester	
PFOA-Free stain resistant finish	
Acrylic backing	
ZGT01/901380-001	Ice
ZGT02/901380-002	Oyster
ZGT03/901380-003	Aluminum
ZGT04/901380-004	Placid
ZGT05/901380-005	Patina
ZGT06/901380-006	Midas
ZGT07/901380-007	Medal

Hum - Maharam	
54" wide	
73% polyester	
27% recycled polyester	
Z2501/901890-001	Ash
Z2502/901890-002	Birch
Z2503/901890-003	Sandbar
Z2504/901890-004	Scallop
Z2505/901890-005	Kernel
Z2506/901890-006	Thyme
Z2507/901890-007	Caledon
Z2508/901890-008	Tide
Z2509/901890-009	Hearth
Z2510/901890-010	Postal
Z2511/901890-011	Briar
Z2512/901890-012	Molten

Morse - Maharam	
66" wide	
100% post-industrial recycled polyester	
ZM101/901720-001	Talc
ZM104/901720-004	Cliff

Skein - Maharam	
54" wide	
56% recycled polyester	
44% polyester	
Z3201/466170-001	Burrow
Z3202/466170-002	Thatch
Z3204/466170-004	Sumac
Z3205/466170-005	Pomegranate
Z3206/466170-006	Cavern
Z3208/466170-008	Cinder
Z3209/466170-009	Dock
Z3210/466170-010	Cadet
Z3211/466170-011	Marsh

Sketch - Maharam	
66" wide	
52% post-consumer recycled polyester	
48% post-industrial recycled polyester	
ZSC01/901780-001	Macaroon
ZSC02/901780-002	Cashew
ZSC03/901780-003	Toffee
ZSC05/901780-005	Amber
ZSC06/901780-005	Carob
ZSC07/901780-007	Pewter
ZSC08/901780-008	Flue
ZSC09/901780-009	Abbyss
ZSC12/901780-012	Zinc

Price Category F

Adjourn - Maharam	
72" wide	
57% polyester	
43% Trevira CS polyester	
ZA102/511350-002	Guava
ZA103/511350-003	Bran
ZA104/511350-004	Flax
ZA105/511350-005	Oatmeal
ZA109/511350-009	Terrain

Crush - Maharam	
54" wide	
88% nylon	
6% acrylic	
6% polyolefin	
VS01/464780-001	001
VS02/464780-002	002
VS05/464780-005	005
VS08/464780-008	008
VS13/464780-013	013
VS16/464780-016	016
VS17/464780-017	017
VS18/464780-018	018
VS19/464780-019	019
VS20/464780-020	020
VS22/464780-022	022
VS23/464780-023	023
VS26/464780-026	026
VS27/464780-027	027

Plait - Maharam	
58" wide	
68% recycled polyester	
32% polyester	
Z2901/466052-001	Cobblestone
Z2902/466052-002	Sachet
Z2903/466052-003	Mesa
Z2904/466052-004	Tavern
Z2905/466052-005	Sequoia
Z2906/466052-006	Rhubarb
Z2907/466052-007	Sangria
Z2908/466052-008	Reef
Z2909/466052-009	Stormy
Z2910/466052-010	Dapper

- Maharam textiles are on assigned lead times [\[A\]](#).
- Fabric numbers are listed as Herman Miller fabric number/Maharam fabric number.

Price Category F continued on next page

Maharam® Colors — Workspaces

continued

Price Category F

continued

Sharkskin 2 - Maharam	
54" wide	
89% polyester	
11% solution-dyed polyester	
PFOA-Free stain resistant finish	
Acrylic backing	
ZS201/901650-033	Harmony
ZS202/901650-034	Suggestion
ZS203/901650-039	Lyric
ZS204/901650-040	Clarify
ZS205/901650-041	Remain
ZS206/901650-046	Sphere
ZS207/901650-051	Restore
ZS208/901650-054	Tawny
ZS209/901650-056	Frosted
ZS210/901650-057	Regal
ZS211/901650-058	Wash
ZS212/901650-059	Navy
ZS213/901650-060	Neon
ZS214/901650-061	Azalea

Price Category G

Ticker - Maharam	
54" wide	
47% polyester	
31% post-industrial recycled polyester	
22% post-consumer recycled polyester	
Crypton green finish and backing	
ZT401/466304-001	Calm
ZT402/466304-002	Millet
ZT403/466304-003	Sow
ZT404/466304-004	Beaver
ZT405/466304-005	Patch
ZT406/466304-006	Balloon
ZT407/466304-007	Squad
ZT408/466304-008	Bale
ZT409/466304-009	Fecund
ZT410/466304-010	Aquarium
ZT411/466304-011	Drink
ZT412/466304-012	Depth
ZT413/466304-013	Far

Price Category H-Z

No fabrics available at this time.

- Maharam textiles are on assigned lead times [\[A\]](#).
- Fabric numbers are listed as Herman Miller fabric number/Maharam fabric number.



Proprietary Textiles Application Chart — Seating

• Available

[A] Assigned lead-time textile.

See following page for exception notes.

[N] Non-woven textile.

Price Category 1

	Aeron® Chairs	Cosm™ Chairs	Mirra® 2 Chairs/Stools	Celle® Chairs/Stools	Embody® Chairs	Sayl® Work Chairs/Stools	Sayl Side Chairs	Setu® Chairs/Stools	Setu Lounge Chair/Ottoman	Verus™ Work Chairs/Stools Back	Verus Work Chairs/Stools Seat	Verus Side Chairs Back	Verus Side Chairs Seat	Ergon 3® Chairs	Equa 2 Fully Upholstered Chairs/Stools	Equa 2 Split-Pad Upholstered Chairs/Stools	Aside® Chairs	Caper® Chairs/Stools	Celeste™ Seating	Keyn Chair Group Back	Keyn Chair Group Seat	Lino™ Chairs Back	Lino Chairs Seat	Locale® Bench Cushion	Public Office Landscape® Back	Public Office Landscape Seat	Plex™ Lounge Furniture	Swoop™ Lounge Seating - Fully Upholstered	Swoop Lounge Seating - Plywood	Eames Tandem Sling Seating	Cushion Tops	Workspaces			
COM Customer's Own Material [A]			14			1	1							1	1	1	1		1		1			1			1	1	1	1	1	1	1		
231__ 8Z Pellicle®	•																																		
1A7__ AireWeave™ 2			•																																
3P__ ColorGuard [N]			15	•	22	•	•	•	•	•	•	•	•	2	3	8				•	•	•		•				•	•	6	•	•			
8T__ Crossing				•				•	•					•	•	•							•					•	•			•	•		
3DE__ Dex			14	•	•	•	•	•	•	•	•	•	•							•	•				•	19	•					•	•		
4RM__ Duo																						•													
6V__ Flexnet™																		•																	
95__ Gem			14					•	•					•	•	•	•							•				•	•				•	•	
845__ Intercept		•																																	
65__ Interweave										•		•																							
4W__ Lyrus 2™									•	•																									
1MN__ Monologue			14			24	22	•	•		•	•	•	•						•	•	•		•	•		•	•	•	•			•	•	
3DK__ Stretch Knit [A]											21																								
235__ Tailored [A]				•	•	•	•	•	•	•	•	•	•							•	•	•					•	23						•	
1WS__ Whisper			14			24	•	•	•	•	•	•	•	•	•	•	•			•	•	•		•	•		•	•	•	•				•	•

Price Category 2

3AR__ Aristo			14			•	•	•	•	•	•	•	•	•	•	•	•			•	•	•	•	•	•	•	•	•	•	•	•	•	•	•
92__ Crepe				•	•	•	•	•	•	•	•	•	•	•	•	•	•			•	•	•	•	•	•	•	•	•	•	•	•	•	•	•
3EP__ Epic			14	•	•			•	•	•	•	•	•							•	•	•	•	•	•	•	•	•	•	•	•	•	•	•
22Q__ Fish Net				•	•	•	•	•	•	•	•	•	•	•	•	•	•			•	•	•	•	•	•	•	•	•	•	•	•	•	•	•
1LM__ Loom			14	•	•			•	•	•	•	•	•							•	•	•	•	•	•	•		•	•	•	•	•	•	•
1MV__ Marvel						21	22													•	•													•
1HA__ Medley			14	•	•	22				•	•	•	•	•	•	•	•			•	•	•	•	•	•	•	•	•	•	•	•	•	•	•
3A__ Moiré			14	•	•	•	•	•	•	•	•	•	•	•	•	•	•			•	•	•	•	•	•	•	•	•	•	•	•	•	•	•
30__ Rhythm				•	23	•	•	•	•	•	•	•	•	•	•	•	•			•	•	•	•	•	•	•	•	•	•	•	•	•	•	•
1RV__ Rivet			14			21	22			•	•	•	•	•	•	•	•			•	•	•	•	•	•	•	•	•	•	•	•	•	•	•
8R__ Twist				•	•	•	•	•	•	•	•	•	•	•	•	•	•			•	•	•	•	•	•	•	•	•	•	•	•	•	•	•
22T__ Well Suited															•	8											•	23					•	

Price Category 3

3AC__ Ace						21	•	•	•	•	•	•	•	•	•	3	8			•	•	•	•	•	•	•	•	19					•		
70__ Bento							•	•	•	•	•	•	•	•	2	•	8			•	•	•	•	•	•	•								•	
8M__ Latitude™				23			•	•								3							•												
22R__ Pins and Needles			14	•	•	•		•	•	•	•	•	•	•	•	•	•								•	•									•
8U__ Stitches				•	•	•	•	•	•	•	•	•	•	•	•	•	•			•	•	•	•	•	•	•	•	•	•	•	•	•	•	•	•
22V__ String Plaid			14	•	•			•	•	•	•	•	•				•			•	•	•	•	•	•	•	•	•	•	•	•	•	•	•	

Price Category 4

7Y__ Bingo [N]						•	•	•	•	•	•	•	•	2	3	8				•	•	•		•										•	
1DL__ Dialogue																									•										
213__ Mercer			14	•	21	22			•	•	•	•	•							•	•	•	•	•	•	•	•	•	•	•	•	•	•	•	•
1A9__ Network																									•										
6J__ Plateau															•	•	•	•																•	
6S__ Quilty			14	•	•			•	•	•	•	•	•	•	•	•	•			•	•	•	•	•	•	•	•	•	•	•	•	•	•	•	•
8Y__ Spools			14	21	•	•	•	•	•	•	•	•	•	•	•	•	•			•	•	•	•	•	•	•	•	•	•	•	•	•	•	•	•
22P__ Strata				•	•	•		•	•	•	•	•	•	•	•	•	•			•	•	•	•	•	•	•	•	•	•	•	•	•	•	•	•

continued on next page

Proprietary Textiles Application Chart — Seating

continued

- Available

[A] Assigned lead-time textile.

See below for exception notes.

[N] Non-woven textile.

	Aeron® Chairs	Cosm™ Chairs	Mirra® 2 Chairs/Stools	Celle® Chairs/Stools	Embody® Chairs	Sayl® Work Chairs/Stools	Sayl Side Chairs	Setu® Chairs/Stools	Setu Lounge Chair/Ottoman	Verus™ Work Chairs/Stools Back	Verus Work Chairs/Stools Seat	Verus Side Chairs Back	Verus Side Chairs Seat	Ergon 3® Chairs	Equa 2 Fully Upholstered Chairs/Stools	Equa 2 Split-Pad Upholstered Chairs/Stools	Aside® Chairs	Caper® Chairs/Stools	Celeste™ Seating	Keyn Chair Group Back	Keyn Chair Group Seat	Lino™ Chairs Back	Lino Chairs Seat	Locale® Bench Cushion	Public Office Landscape® Back	Public Office Landscape Seat	Plex™ Lounge Furniture	Swoop™ Lounge Seating - Fully Upholstered	Swoop Lounge Seating - Plywood	Eames Tandem Sling Seating	Cushion Tops	Workspaces		
Price Category 5																																		
14A__ Hopsak			14		•	•	•	•	•	•	•	•	•	•	•	•	•			•	•	•		•	•			•	•	•	•	•	•	•
22N__ Noble (22H__) [A]			14		•	25	•			•	•	•	•	•	•	3	8			•	•	•		•	•			•	•	•	•	•	•	•
Price Category 6																																		
35__ Balance					•																													
Price Category 7																																		
COL Customer's Own Leather [A]	1		14											1	1	1	8																	1
Price Category 8																																		
No fabrics available at this time																																		
Price Category 9																																		
21__ Leather	23		14												•	•	8		4			•									•		•	

continued on next page

Proprietary Textiles Application Chart — Seating

• Available

[A] Assigned lead-time textile.

See following page for exception notes.

[N] Non-woven textile.

All foam and Proprietary Textiles on

HermanMiller seating comply with California TB 117-2013.

Fire-Retardant Chairs/Fabrics

	Aeron® Chairs - Graphite	Mirra® 2 Chairs/Stools with Butterfly Back	Celle® Chairs/Stools	Embody® Chairs	Sayl® Work Chairs/Stools	Sayl Side Chairs	Setu® Chairs/Stools	Setu Lounge Chair/Ottoman	Ergon 3® Chairs	Equa 2® Fully Upholstered Chairs/Stools	Equa 2 Split-Pad Upholstered Chairs/Stools	Aside® Chairs	Caper® Chairs/Stools	Celeste™ Seating	Plex™ Lounge Furniture	Swoop™ Lounge Seating - Fully Upholstered	Fames™ Tandem Sling Seating
Price Category 1																	
COM Customer's Own Material [A]									1	1	1	1	1				
23103 8Z Pellicle - Graphite	•																
1A7__ AireWeave™ 2		•															
3P__ ColorGuard [N]			15	24	22			2		3	8					•	6
8T__ Crossing			14			•	•	•	•	•	•			•		•	
3DE__ Dex			14		•	•	•							•	19	•	
6V__ Flexnet™													•				
95__ Gem			14			•	•	•	•	•	•			•	•	•	
4W__ Lyris 2™							18	•									
1MN__ Monologue			14	21	22	•	•	2						•	•	•	
235__ Tailored [A]		•				•								•	•	•	
1WS__ Whisper			14	21	22	•	•	•	•	•	•			•	•	•	
Price Category 2																	
3AR__ Aristo			14		•	•	•	•					•	•	•	•	
92__ Crepe			14		•	•				•	•	•		•	•	•	
3EP__ Epic			14		•	•						•		•	•	•	
22Q__ Fish Net			•		•	•	•								•		
3A__ Moiré			14		•	•	•	•	•	•	•			•			
30__ Rhythm			14	24	•							8				•	
1RV__ Rivet			14	21	22	•						•		•	•	•	
8R__ Twist			14		•	•	•	•	•			•	8	•	•	•	
Price Category 3																	
70__ Bento					•	•	•	•	2	•		8				•	
8M__ Latitude™			•		•	•											
22R__ Pins and Needles					•	•	•										
8U__ Stitches			14		•	•	•	•	•	•	•	•			•	•	•
22V__ String Plaid					•									•			
Price Category 4																	
6J__ Plateau												•					
6S__ Quilty			14		•	•											•
Price Category 5																	
14A__ Hopsak			14		•			•	•	•	•				•	•	
Price Category 6																	
35__ Balance				17													
Price Category 9																	
21__ Leather			14									8					

Application Note: Herman Miller cannot guarantee material/pattern alignment in adjacent products. For example, a fabric's pattern may not align from one pedestal cushion top to the next, or from one chair to another.

- 1 Refer to price book appendices and Omni for COM/COL information.
- 2 Available on all Ergon 3 chairs except for fabric back (FB) option.
- 3 Available on A-and B-size Equa 2 split-pad upholstered chairs.
- 4 See specific products for information on specifying leather in combination with fabric.
- 6 Only available in 3P02 Navy, 3P03 Spruce, 3P14 Black, 3P19 Slate, and 3PC7 Bucksuede.
- 8 Only available on nonupholstered outer back option (PB).
- 14 Available on Celle UC (upholstered seat) and HC (upholstered seat with protective edge) Chairs.
- 15 Available only on Celle HC (upholstered seat with protective edge) Chairs.
- 17 Only available in 3512 Carbon and 3513 Black.
- 18 Only available in 4W26 Slate Grey, 4W30 Java, and 4W31 Graphite.
- 19 Available on Plex seat only.
- 21 Not available on Sayl upholstered back work chairs.
- 22 Not available on Sayl side chairs with upholstered backs.
- 23 Available in select colors. Refer to "Proprietary Textile Colors-Seating" for color offering.
- 24 Not available on Sayl upholstered High-Back Work Chairs.
- 25 Not available on Sayl side chairs with upholstered backs. Available in select colors. Refer to "Proprietary Textile Colors-Seating" for color offering.



Proprietary Textile Colors — Seating

Price Category 1

Customer's Own Material
See Order Information in
Appendices.
Assigned lead-time textile. A

8Z Pellicle®
For New Aeron® Chairs
56% elastomeric
44% polyester
23101 Mineral
23102 Carbon
23103 Graphite

AireWeave™ 2
For Mirra® 2 Chairs
67% elastomeric
33% antimony-free polyester
1A701 Alpine
1A702 Slate Grey
1A703 Graphite
1A704 Lime Green
1A705 Cappuccino
1A706 Urban Orange
1A707 Dark Turquoise
1A708 Twilight

ColorGuard
54" wide
100% vinyl
3P01 Grey
3P02 Navy *
3P03 Spruce * A
3P08 Blueberry A
3P12 Black Plum A
3P14 Black *
3P19 Slate *
3P31 Horizon Blue A
3P33 Pumice
3P54 Candy Apple A
3P72 Allspice A
3P96 Manzanita A
3P97 Fudge A
3PB2 Sea Grass A
3PB5 Vizcaya Palm A
3PB9 Neptune A
3PC7 Bucksuede * A
3PD4 Otter A

* Colors available on Eames®
Tandem Sling Seating.
A Assigned lead-time color.

Crossing
54" wide
86% antimony-free polyester
14% polyester
8T03 Wicker
8T04 Porcelain
8T05 Warm Grey
8T06 Sepia
8T07 Pumpkin
8T08 Copper
8T09 Cranberry
8T10 Tomato
8T11 Mulberry
8T12 Plum
8T13 Green Apple
8T14 Loden
8T15 Spruce
8T16 Periwinkle
8T17 Cerulean
8T18 Indigo
8T19 Shale
8T20 Brownstone
8T21 Bark
8T22 Tin
8T23 Graphite
8T24 Black

Dex
54" wide
50% recycled polyester
50% polyester
3DE01 Frost
3DE02 Silver Pine
3DE03 Stone
3DE04 Shale
3DE05 Charcoal

Duo
For Lino™ Chairs
52% polyester
48% elastomeric
4RM01 Mineral
4RM02 Poppy
4RM03 Green Leaf
4RM04 Jade
4RM05 Shadow
4RM06 Graphite

Flexnet™
For Caper® Chairs
69% elastomeric
31% polyester
6V01 Black
6V02 Silver Grey

Gem
54" wide
100% antimony-free polyester
9501 Sesame
9502 Tangerine
9503 Red
9504 Red Violet
9505 Mulberry
9506 Java
9507 Twilight
9508 Bayou
9509 Iris
9510 Berry Blue
9511 Aqua Green
9512 Green Apple
9513 Spruce
9514 Black
9515 Slate Grey
9516 Fog

Intercept
For Cosm™ Chairs
60% elastomeric
40% polyester
84501 Graphite
84502 Carbon
84503 Mineral
84504 Nightfall
84505 Glacier
84506 Canyon

Interweave
For Verus™ Chairs
71% elastomeric
29% polyester
6504 Pewter
6505 Charcoal
6506 Black

Price category 1 continued on
next page

Proprietary Textile Colors — Seating

continued

Price Category 1

continued

Appendix: Proprietary Textile Colors — Seating

Lyris 2™	
For Setu® Chairs	
74% elastomeric	
26% polyester	
4W21	Alpine
4W22	Mango
4W23	Chartreuse
4W25	Berry Blue
4W26	Slate Grey
4W28	Chino
4W29	Rattan
4W30	Java
4W31	Graphite

Monologue	
54" wide	
56% recycled polyester	
44% polyester	
1MN01	Linen
1MN02	Alabaster
1MN03	Truffle
1MN04	Folkstone
1MN05	Silver Pine
1MN06	Slate
1MN07	Seed
1MN08	Yellow Oxide
1MN09	Persimmon
1MN10	Tundra
1MN11	Meadow
1MN12	Blue Sky
1MN13	Blue Spruce
1MN14	Deep Sea

Stretch Knit	
Assigned lead-time textile. A	
Available only on Sayl®	
Suspension Back Work Chairs	
97% polyester, 3% spandex	
3DK01	Fog
3DK02	Slate Grey
3DK03	Java
3DK04	Black
3DK05	Red
3DK06	Green Apple
3DK07	Berry Blue

Tailored	
Assigned lead-time textile. A	
54" wide	
56% polyester	
44% recycled polyester	
23501	Studio White *
23502	Sugar *
23503	Tomato
23504	Orchid
23505	Boysenberry
23506	Chive
23507	Bluegrass
23508	Cobalt
23509	Cadet
23510	Fog
23511	Graphite
23512	Black
23513	Coffee

* Colors not available on Plex™ Lounge Furniture.

Whisper	
54" wide	
73% recycled polyester	
27% polyester	
1WS01	Sand Dollar
1WS02	Pebble
1WS03	Silver Birch
1WS04	Iceberg
1WS05	Silver Pine
1WS06	Carbon
1WS07	Cumin
1WS08	Adobe
1WS09	Strawberry
1WS10	Blush
1WS11	Eggplant
1WS12	Willow
1WS13	Sea Grass
1WS14	Pool
1WS15	Blueberry

Price Category 2

Aristo	
54" wide	
88% recycled polyester	
12% polyester	
Acrylic backing	
3AR01	Forest Moss
3AR02	Light Brindle
3AR03	Mink
3AR04	Copper
3AR05	Adobe
3AR06	Cherry
3AR07	Lilac
3AR08	Green Apple
3AR09	Surf
3AR10	Waterfall
3AR11	Cadet
3AR12	Tin
3AR13	Pewter
3AR14	Grey Brindle
3AR15	Grey Black

Crepe	
54" wide	
100% recycled polyester	
9201	Licorice
9203	Smoke
9207	Cherry
9209	Claret
9212	Raisin
9218	Aquamarine
9223	Cadet
9241	Beachglass
9243	Midnight
9244	Artichoke
9248	Warm White
9249	Stone
9250	Earth
9251	Fog
9252	Slate Grey
9253	Yellow Dark
9254	Coral
9255	Blush Grey
9256	Wild Berry
9257	Clover
9258	Caribbean
9259	Cerulean

Crepe continued	
9260	Brownstone
9261	Shale
9262	Graphite
9263	Tomato
9264	Green Apple

Epic	
54" wide	
56% recycled polyester	
44% polyester	
Acrylic backing	
3EP01	Alabaster
3EP02	Smoke
3EP03	Falcon
3EP04	Citrus Spring
3EP05	Copper
3EP06	Urban Orange
3EP07	Poppy
3EP08	Wild Plum
3EP09	Sugar Plum
3EP10	Clover
3EP11	Loden
3EP12	Everglade
3EP13	Mist
3EP14	Peacock
3EP15	Cadet
3EP16	Indigo
3EP17	Spring Wood
3EP18	Grey Brindle
3EP19	Seed
3EP20	Carbon Dark

Price category 2 continued on next page

Proprietary Textile Colors — Seating

continued

Price Category 2

continued

Fish Net

55" wide	
100% recycled polyester	
22Q01	Oyster
22Q02	Stone
22Q03	Citrus
22Q04	Curry
22Q05	Chipotle
22Q06	Cherry
22Q07	Fuschia
22Q08	Claret
22Q09	Purple
22Q10	Clover
22Q11	Pesto
22Q12	Peacock
22Q13	Lagoon
22Q14	Twilight
22Q15	Bluestone
22Q16	Storm
22Q17	Black
22Q18	Cocoa

Loom

54" wide	
100% polyester	
1LM01	Linen
1LM02	Brown Sugar and Spice
1LM03	Brick and Mortar
1LM04	Salt and Pepper
1LM05	Black
1LM06	Lemongrass
1LM07	Poppy
1LM08	Wild Berry
1LM09	Loden
1LM10	Jade
1LM11	Deep Sea

Marvel

54" wide	
100% pvc-free polyurethane	
1MV01	Summer White
1MV02	Sand Dollar
1MV03	Espresso
1MV04	Folkstone Grey
1MV05	Graphite
1MV06	Onyx
1MV07	Polar Blue
1MV08	Blush Grey
1MV09	Woodrose
1MV10	Citrus
1MV11	Adobe
1MV12	Red
1MV13	Kiwi Green
1MV14	Pine
1MV15	Teal Green
1MV16	Twilight

Medley

54" wide	
100% polyester	
1HA01	Stone
1HA02	Trail
1HA03	Charcoal
1HA04	Cinder
1HA05	Citrus
1HA06	Papaya
1HA07	Chutney
1HA08	Tundra
1HA09	Feather Grey
1HA10	Chartreuse
1HA11	Loden
1HA12	Peacock
1HA13	Bayou
1HA14	Blue Grotto
1HA15	Blueberry
1HA22	Khaki
1HA23	Pewter
1HA24	Yellow Oxide
1HA25	Vintage Rose
1HA26	Raspberry
1HA27	Acai Berry

Moiré

54" wide	
100% recycled polyester	
3A01	Concrete
3A02	Biscotti
3A03	Rattan
3A04	Chambray
3A05	Fern
3A08	Violet
3A09	Zin
3A10	Curry
3A11	Spice
3A12	Cork

Rhythm

54" wide	
100% polyester	
3001	Kiwi Green *
3002	Green Apple
3003	Peacock
3004	Bayou *
3005	Berry Blue
3006	Iris
3007	Twilight
3008	Pumpkin *
3009	Poppy *
3010	Molasses
3011	Mulberry
3012	Khaki *
3013	Mink
3014	Black
3015	Charcoal

* Colors not available on Embody® Chair.

Rivet

54" wide	
100% recycled polyester	
1RV01	Twig
1RV02	Deep Clay
1RV03	Woodrose
1RV04	Otter
1RV05	Hemlock
1RV06	Olive
1RV07	Lagoon
1RV08	Deep Sea
1RV09	Charcoal
1RV10	Grey Brindle

Twist

54" wide	
80% antimony-free polyester	
13% recycled polyester	
7% polyester	
8R05	Wicker
8R10	Poppy
8R14	Tin
8R15	Shale
8R16	Graphite
8R17	Birch
8R18	Sepia
8R22	Blueberry
8R23	Green Apple
8R26	Gunmetal
8R27	Cinder
8R28	Citrus
8R29	Pekoe
8R30	Tangerine
8R31	Red Plum
8R32	Wisteria
8R33	Forest
8R34	Jade Dark
8R35	Waterfall
8R36	Midnight Blue
8R37	Carbon Dark

Price category 2 continued on next page

Proprietary Textile Colors — Seating

continued

Price Category 2

continued

Well Suited

55" wide
79% polyester
21% recycled polyester

22T01	Oyster *
22T02	Raffia *
22T03	Peppermint *
22T04	Wild Berry *
22T05	Spring Green *
22T06	Mint *
22T07	Periwinkle *
22T08	Cool Grey *
22T09	Citrus *
22T10	Pumpkin
22T11	Red
22T12	Fuschia
22T13	Orchid
22T14	Chartreuse *
22T15	Green Apple
22T16	Jade
22T17	Peacock
22T18	Blueberry
22T19	Bluestone *
22T20	Mink

* Colors not available on Swoop™ Plywood Lounge Seating.

Price Category 3

Ace

54" wide
100% polyurethane
Polyester knit backing
Stain resistant finish

3AC01	Summer White
3AC02	White Ash
3AC03	Rye
3AC04	Metal
3AC05	Clay
3AC06	Chestnut
3AC07	Citrus
3AC08	Camelback
3AC09	Chipotle
3AC10	Claret
3AC11	Slate Purple
3AC12	Artichoke
3AC13	Sepia Dark
3AC14	Aloe
3AC15	Flint
3AC16	Blue Sky
3AC17	Oceanside
3AC18	Midnight
3AC19	Spring Wood
3AC20	Frost
3AC21	Lead
3AC22	Black

Bento

54" wide
100% antimony-free polyester

7001	Frost
7002	Linen
7003	Khaki
7004	Truffle
7005	Grey Black
7006	Pumpkin
7007	Cranberry
7008	Everglade
7009	Cobalt

Latitude™

61" wide
100% polyester

8M01	Graphite
8M02	Shadow
8M10	Alpine
8M17	Black
8M21	Slate Grey
8M22	Lime Green
8M23	French Press
8M24	Urban Orange
8M25	Dark Turquoise
8M26	Twilight

Latitude

Colors for Mirra 2 Chairs
100% polyester

8M10	Alpine
8M17	Black
8M21	Slate Grey
8M22	Lime Green
8M23	French Press
8M24	Urban Orange
8M25	Dark Turquoise
8M26	Twilight

Pins and Needles

58" wide
76% recycled polyester
24% polyester

22R01	Day and Night
22R02	Night and Day

Stitches

54" wide
54% polyester
46% recycled polyester

8U02	Rye
8U03	Khaki
8U04	Honey
8U05	Cattail
8U08	Cool Grey
8U09	Slate Blue
8U11	Evening Blue
8U12	Charcoal
8U13	Kiwi Green
8U16	Cocoa
8U17	Seed

String Plaid

54" wide
100% recycled polyester

22V01	Warm White on Khaki
22V02	Mint on Yellow Green
22V03	Mist on Blue Grey
22V04	Sky Blue on Red
22V05	Lime on Magenta
22V06	Bright Green on Green
22V07	Aqua Blue on Cerulean
22V08	Ivory on Black

Proprietary Textile Colors — Seating

continued

Price Category 4

Bingo

54" wide
100% PVC-free polyurethane
Resilience® finish

7Y01	Oyster
7Y02	Natural
7Y03	Cashew
7Y05	Rattan
7Y06	Root
7Y07	Woodland
7Y10	Allspice
7Y11	Canyon
7Y17	Seed
7Y18	Mushroom
7Y19	Blue Grey
7Y21	Black
7Y22	Mint
7Y23	Seaport
7Y24	Evening Blue
7Y26	Kiwi Green
7Y27	Celadon
7Y29	Pesto

Dialogue

For Public Office Landscape®
Sectional Back/Social Chair Back
knit to size
100% polyester

1DL01	Light Brindle
1DL02	Dark Brindle

Mercer

54" wide
50% solution dyed recycled nylon
50% solution dyed nylon
BLOCKaide

21301	Stone
21303	Cayenne
21305	Pesto
21306	Teal Blue
21307	Ultramarine
21310	Charcoal

Network

For Public Office Landscape®
Sectional Back/Social Chair Back
knit to size
100% polyester

1A901	Warm White
1A902	Fog
1A903	Red
1A904	Wildberry
1A905	Green Apple
1A906	Twilight
1A907	Graphite

Plateau

Perspectives® Collection

knit to size
100% polyester

6J01	Feather Grey
6J02	Trail
6J06	Twig
6J08	Sagebrush
6J09	Winter Berry
6J10	Thunder
6J11	Blueberry
6J12	Rosemary
6J14	Black

Quilty

56" wide
100% antimony-free polyester
GreenShield

6S03	Khaki
6S04	Straw
6S07	Brick
6S10	Mink
6S11	Green Apple
6S13	Indigo
6S14	Zinc
6S15	Slate
6S16	Beachwood
6S17	Paprika
6S18	Plum
6S19	Juniper
6S20	Grey Black

Spools

54" wide
51% recycled polyester
49% polyester
Crypton® Green

8Y03	Trail
8Y05	Copper
8Y08	Bluegrass
8Y09	Lagoon
8Y11	Beachglass
8Y12	Marsh
8Y13	Bud

Strata

54" wide
50% solution dyed recycled nylon
50% solution dyed nylon
BLOCKaide

22P04	Pesto
22P05	Peacock
22P06	Blue Jay
22P07	Blueberry
22P09	Mango
22P10	Paprika
22P12	Wheat
22P13	Brownstone
22P14	Bayou

Price Category 5

Hopsak

56" wide
100% recycled polyester

14A20	Black
14A22	Raw Umber Dark
14A26	Grey Blue Dark
14A30	Sepia Dark
14A38	Emerald Dark
14A39	Yellow Dark
14A40	Orange
14A41	Sienna
14A42	Olive Green Dark
14A43	Crimson
14A44	Crimson Dark Dark
14A45	Violet Dark
14A46	Pink Dark Dark
14A47	Ultramarine Dark
14A48	Cobalt Blue
14A49	Terra Cotta
14A50	Ochre Dark

Noble

Assigned lead-time textile. ^A

54" wide 100% wool	
22N02	Chipotle *
22N04	Cherry *
22N07	Cadet *
22N08	Berry Blue *
22N09	Peacock *
22N11	Pesto *
22N12	Blue Grey Mix *
22H15	Heathered Black **
22H16	Heathered Grey **
22H17	Heathered Twilight **
22H18	Heathered Rye Grass **
22N19	Lemongrass Mix *
22H20	Heathered Red **
22H21	Heathered Wild Berry **
22N22	Pesto Mix *
22N23	Lagoon Mix *

* Colors not available on Sayl® Side Chairs.

** Colors not available on Sayl Side Chairs Back.

Proprietary Textile Colors — Seating

continued

Price Category 6

Balance

For Embody® chairs
100% polyester

3506	Green Apple
3507	Blue Moon
3509	Berry Blue
3510	Iris
3512	Carbon
3513	Black

Price Category 7

Customer's Own Leather

See Order Information in
Appendices. Assigned lead-time
textile. A

Price Category 8

No fabrics available at this time.

Price Category 9

Leather

approx. 50 sq. ft. per hide
100% leather

2101	Ivory
2109	Black *
2110	Smoke
2111	Graphite
2112	Khaki
2113	Rattan
2114	Truffle
2115	Alpine
2116	Haze
2117	Sable Grey
2118	Dark Mineral **
2119	Dark Carbon ***
2120	Cranberry
2121	Deep Sea

* Armpad color available on
Aeron® Chair, Graphite.
** Armpad color available on
Aeron Chair, Mineral.
*** Armpad color available on
Aeron Chair, Carbon.

Maharam® Application Chart — Seating

- Available

See below for exception notes.

Maharam textiles are on assigned lead times. A

[N] Non-woven textile.

	Mirra® Chairs/Stools	Celle® Chairs	Sayl® Work Chairs/Stools	Sayl Side Chairs	Setu® Chairs/Stools	Setu Lounge Chair/Ottoman	Verus™ Work Chairs/Stools Back	Verus Work Chairs/Stools Seat	Verus Side Chairs Back	Verus Side Chairs Seat	Ergon 3® Chairs	Equa 2® Fully Upholstered Chairs/Stools	Equa 2 Split-Pad Upholstered Chairs/Stools	Aside® Chairs	Caper® Chairs/Stools	Celeste™ Seating	Keyn Chair Group Back	Keyn Chair Group Seat	Lino™ Chairs Seat	Locale® Bench Cushions	Public Office Landscape® Seat	Plex™ Lounge Furniture	Swoop™ Lounge Seating - Fully Upholstered	Swoop Lounge Seating - Plywood	Cushion Tops	Workspaces		
Price Category 1-2																												
No fabrics available at this time.																												
Price Category 3																												
ZM2__ Meld - Maharam	14	•	•	•	•	•	•	•	•	•	•	•	•	•	•	•	•	•	•	•	•	•	•	•	•	•	•	
Price Category 4-9																												
No fabrics available at this time.																												
Price Category A																												
No fabrics available at this time.																												
Price Category B																												
VM__ Medium - Maharam	14	•	•				•	•			•	•	•	•	•	•							•	•	•	•	•	
TI__ Messenger - Maharam *	14	•	•	•	•	•	•	•	•	•		•	•			•	•	•	•				•	•	•	•	•	
Price Category C																												
ZLR__ Lariat - Maharam [N]	14	•	•				•	•									•	•				•	20			•		
Z27__ Manner - Maharam	14	•	•				•	•	•	•	•	•	•			•	•	•	•				•	•	•	•	•	
Z3__ Metric - Maharam	14	•	•				•	•	•	•	•	•	•			•	•	•	•				•	•	•	•	•	
Price Category D																												
ZMD__ Mode - Maharam	14	18	•				•	•	•			•	•					•	•			•	•	•	•	•	•	
Price Category E																												
ZFS__ Focus - Maharam	14	16	16									•					•									•		
VgG__ Ledger - Maharam [N]	14	18	16				•	•	•							•	•	•								•		
ZBQ__ Oblique - Maharam			16				•	•	•			•					•	•					•	•	•			
ZP2__ Pick - Maharam		18	•				•	•	•			•					•	•					•	•	•			
Z32__ Skein - Maharam	14	16	16	•								•					•	•								•	•	
ZT3__ Technic - Maharam	14	18	•									•					•	•										
Price Category F																												
ZCH__ Chock - Maharam			•									•																
ZC8__ Coin - Maharam	14	•	16									•					•									•		
ZCJ__ Coincide - Maharam		16	•														•									•		
VS__ Crush - Maharam				•	•											•							•			•		
ZD1__ Disc - Maharam	14	18	16									•					•	•								•		
ZD3__ Divide - Maharam	14	18	•									•					•	•								•		
ZEE__ Exchange - Maharam	14	18	16				•	•				•					•	•				20				•		
Z29__ Plait - Maharam	14	16	•				•	•	•							•	•						•	•	•	•	•	
V26__ Remix - Maharam		16	16													•	•	•				•		•	•	•	•	
ZRV__ Rove - Maharam	14	16	•				•	•									•	•										
ZRA__ Runner Standard - Maharam	14	18	•														•	•										
ZSM__ Seam - Maharam	14	•	•									•					•	•										
Z31__ Sequence - Maharam	14	•	•				•					•	•			•	•						•			•		
ZSS__ Shuttle Standard - Maharam	14	•	•														•	•										
Z33__ Strum - Maharam [N]			16													•	•					•						
ZWX__ Waxen - Maharam	14	16	•																									

* Available in select colors on 20-day lead-time.
Refer to "Maharam Colors - Seating" for 20-day colors.

continued on next page

Maharam® Application Chart — Seating *continued*

- Available

See below for exception notes.

Maharam textiles are on assigned lead times. A

[N] Non-woven textile.

	Mirra® Chairs/Stools	Celle® Chairs	Sayl® Work Chairs/Stools	Sayl Side Chairs	Setu® Chairs/Stools	Setu Lounge Chair/Ottoman	Verus™ Work Chairs/Stools Back	Verus Work Chairs/Stools Seat	Verus Side Chairs Back	Verus Side Chairs Seat	Ergon 3® Chairs	Equa 2® Fully Upholstered Chairs/Stools	Equa 2 Split-Pad Upholstered Chairs/Stools	Aside® Chairs	Caper® Chairs/Stools	Celeste™ Seating	Keyn Chair Group Back	Keyn Chair Group Seat	Lino™ Chairs Seat	Locale® Bench Cushions	Public Office Landscape® Seat	Plex™ Lounge Furniture	Swoop™ Lounge Seating - Fully Upholstered	Swoop Lounge Seating - Plywood	Cushion Tops	Workspaces	
Price Category G																											
ZC9__ Coin Crypton - Maharam			•	16				•											•								
ZCF__ Coincide High Performance - Maharam	14	16	16					•		•									•								
ZCQ__ Colline - Maharam																											
ZC2__ Compound - Maharam [N]			16	16				•		•	•		•	8					•	•			•		•		
ZD2__ Disc Crypton - Maharam	14	16	16																•								
ZD4__ Divide Crypton - Maharam	14	16	•																•								
Z23__ Divina MD - Maharam	14	•	16	•			•	•	•	•	•	•	•	•			•	•	•	•			•		•	•	•
TF__ Divina - Maharam	14	•	•	•	•	•	•	•	•	•	•	•	•	•	8		•	•	•	•			•	•	•	•	•
TG__ Divina Melange - Maharam	14	•	•	•	•	•	•	•	•	•	•	•	•	•	8		•	•	•	•			•	•	•	•	•
ZEM__ Emboss - Maharam [N]	14	16	16																•								
ZF1__ Fold - Maharam [N]	14	16	16																•								
ZH1__ Hero by Kvadrat - Maharam	14	•	16				•	•	•	•									•	•							
ZQM__ Omen - Maharam	14	18	16																•								
ZP1__ Pick Crypton - Maharam	14	16	•																•	•							
ZP3__ Pocket - Maharam	14							•		•									•	•				•		•	
ZRG__ Ring - Maharam	14	16	16																•								
ZRF__ Runner - Maharam	14	16	16																•								•
ZSN__ Sheen - Maharam	14	18	•				•	•		•									•								
ZSE__ Steelcut - Maharam			•	•				•		•									•	•			•				
V25__ Steelcut Trio - Maharam	14	16	•																•				•			•	
ZS1__ Stride - Maharam	14	•	•																•								
ZT4__ Ticker - Maharam	14	•	•					•		•									•							•	•
ZVT__ Vestige - Maharam	14	18	•																•	•							
Price Category H																											
ZT__ Circles - Maharam	14	16	16																•								•
ZS__ Crosspatch - Maharam	14		•																•								•
Z2D__ Ditto - Maharam	14	•	16																•				•				•
ZK__ Dot Pattern - Maharam	14	•	•	•	•			•		•				•					•								•
Z24__ Hallingdal - Maharam	14	•	•	•			•	•	•	•	•	•	•	•					•				•			•	•
ZQF__ Offset - Maharam	14	16	•																•								•
ZL__ Small Dot Pattern - Maharam	14	•	•	•	•			•		•				•					•								•
ZTN__ Tonus - Maharam			16	16																•							
Price Category I																											
ZLC__ Latch - Maharam	14	•	•					•		•				•					•								
ZT2__ Teatro - Maharam			•	•				•		•																	
Price Category J																											
ZT1__ Tokyo - Maharam																											•
Price Category K																											
ZC7__ Coda by Kvadrat - Maharam	14	16	16																								•
Price Category L																											
ZMK__ Minicheck - Maharam	14	•	•																								
Price Category M																											
ZF2__ Fruit - Maharam	14		16																								
Price Category N-Z																											
No fabrics available at this time.																											

- 3 Available on A- and B-size Equa 2 split-pad upholstered chairs.
- 8 Only available on nonupholstered outer back option (PB).
- 14 Available on Celle UC (upholstered seat) and HC (upholstered seat with protective edge) chairs.
- 16 Available on Sayl Chair seat.

- 18 Available on Sayl Chair seat and upholstered mid-back.
- 20 Not available on Plex Club Chair with Headrest.

Maharam® Colors — Seating

Price Category 1-2

No fabrics available at this time.

Price Category 3

Meld – Maharam

54" wide
68% post-consumer recycled polyester
32% polyester
PFOA-Free stain resistant
ZM201/466387-201 Vast
ZM202/466387-202 Panda
ZM203/466387-203 Skyline
ZM204/466387-204 Knight
ZM205/466387-205 Quill
ZM206/466387-206 Pipe
ZM207/466387-207 Grate
ZM208/466387-208 Gloss
ZM209/466387-209 Bulb
ZM210/466387-210 Bride
ZM211/466387-211 Stark
ZM212/466387-212 Seashell
ZM213/466387-213 Antler
ZM214/466387-214 Crater
ZM215/466387-215 Perennial
ZM216/466387-216 Mulberry
ZM217/466387-217 Fuchsia
ZM218/466387-218 Amethyst
ZM219/466387-219 Merlot
ZM220/466387-220 Magma
ZM221/466387-221 Rooster
ZM222/466387-222 Heat
ZM223/466387-223 Clementine
ZM224/466387-224 Fox
ZM225/466387-225 Kiss
ZM226/466387-226 Bare
ZM227/466387-227 Blonde
ZM228/466387-228 Mimosa
ZM229/466387-229 Comet
ZM230/466387-230 Honeydew
ZM231/466387-231 Wild
ZM232/466387-232 Vine
ZM233/466387-233 Seed
ZM234/466387-234 Kale

Meld continued

ZM235/466387-235 Waterfall
ZM236/466387-236 Nordic
ZM237/466387-237 Reef
ZM238/466387-238 Wave
ZM239/466387-239 Isle
ZM240/466387-240 Creek
ZM241/466387-241 Mariner
ZM242/466387-242 Globe
ZM243/466387-243 Spa

Price Category 4-9

No fabrics available at this time.

- Maharam textiles are on assigned lead times **A** unless otherwise noted.
- Fabric numbers are listed as Herman Miller fabric number/Maharam fabric number.

Maharam® Colors — Seating

continued

Price Category A

No fabrics available at this time.

Price Category B

Medium – Maharam

54" wide

100% polyester

VM01/463490-001	Raven
VM02/463490-002	Smoke
VM03/463490-003	Alloy
VM04/463490-004	Flax
VM06/463490-006	Bark
VM07/463490-007	Espresso
VM08/463490-008	Pecan
VM12/463490-012	Pumpkin
VM13/463490-013	Persimmon
VM14/463490-014	Laser
VM16/463490-016	Port
VM22/463490-022	Marina
VM29/463490-029	Pistachio
VM32/463490-032	Prospect
VM36/463490-036	Delight
VM39/463490-039	Nautical
VM40/463490-040	Pool
VM44/463490-044	Washed
VM45/463490-045	Sculpture
VM46/463490-046	Thatched
VM47/463490-047	Hike
VM48/463490-048	Tangle
VM49/463490-049	Pacific
VM50/463490-050	Cosmic
VM51/463490-051	Cascade
VM52/463490-052	Blackberry
VM53/463490-053	Nasturtium
VM54/463490-054	Wooded

Messenger – Maharam

54" wide

78% recycled polyester

15% polyester, 7% nylon

TI01/458640-001	Balsa
TI06/458640-006	Tobacco
TI07/458640-007	Shadow *
TI08/458640-008	Bayou *
TI10/458640-010	Zinc
TI24/458640-024	Poppy
TI25/458640-025	Mao
TI29/458640-029	Onyx
TI31/458640-031	Cloud *
TI38/458640-038	Depth *
TI40/458640-040	Nile
TI41/458640-041	Azure *
TI45/458640-045	Cactus *
TI46/458640-046	Ice *
TI48/458640-048	Neon *
TI50/458640-050	Hydrangea *
TI51/458640-051	Lilac
TI52/458640-052	Chestnut
TI53/458640-053	Tangelo
TI54/458640-054	Lumine *
TI58/458640-058	Snow
TI59/458640-059	Fennel
TI60/458640-060	Peridot *
TI61/458640-061	Capri
TI62/458640-062	Ultramarine
TI63/458640-063	Squall
TI66/458640-066	Cassis
TI67/458640-067	Aster
TI68/458640-068	Spice
TI69/458640-069	Cherry
TI70/458640-070	Vibrant
TI71/458640-071	Satsuma *
TI72/458640-072	Maize

Messenger continued

TI76/458640-076	Fossil
TI77/458640-077	Ash
TI78/458640-078	Tusk
TI79/458640-079	Oyster
TI80/458640-080	Pensive
TI81/458640-081	Husk
TI82/458640-082	Fireside
TI83/458640-083	Chili
TI84/458640-084	Robust
TI85/458640-085	Beyond
TI86/458640-086	Voyage
TI87/458640-087	Everglade
TI88/458640-088	Electric

* Colors available on 20-day lead time.

- Maharam textiles are on assigned lead times A unless otherwise noted.
- Fabric numbers are listed as Herman Miller fabric number/Maharam fabric number.

Maharam® Colors — Seating

continued

Price Category C

Lariat – Maharam	
54" wide	
100% vinyl	
ZLR01/440401-001	001
ZLR02/440401-002	002
ZLR03/440401-003	003
ZLR04/440401-004	004
ZLR06/440401-006	006
ZLR07/440401-007	007
ZLR08/440401-008	008
ZLR10/440401-010	010
ZLR11/440401-011	011
ZLR12/440401-012	012
ZLR13/440401-013	013
ZLR14/440401-014	014
ZLR15/440401-015	015
ZLR16/440401-016	016
ZLR18/440401-018	018
ZLR20/440401-020	020
ZLR21/440401-021	021
ZLR23/440401-023	023
ZLR24/440401-024	024
ZLR25/440401-025	025
ZLR26/440401-026	026
ZLR27/440401-027	027
ZLR28/440401-028	028
ZLR29/440401-029	029
ZLR30/440401-030	030
ZLR31/440401-031	031
ZLR32/440401-032	032
ZLR33/440401-033	033
ZLR34/440401-034	034
ZLR35/440401-035	035
ZLR36/440401-036	036
ZLR37/440401-037	037
ZLR38/440401-038	038

Manner - Maharam	
54" wide	
100% recycled polyester	
Z2701/466177-001	Magic
Z2702/466177-002	Carob
Z2703/466177-003	Porpoise
Z2704/466177-004	Flint
Z2705/466177-005	Hush
Z2706/466177-006	Nuance
Z2707/466177-007	Thicket
Z2708/466177-008	Cocoa
Z2709/466177-009	Pathway
Z2710/466177-010	Cola
Z2711/466177-011	Ember
Z2712/466177-012	Wagon
Z2713/466177-013	Ablaze
Z2714/466177-014	Peel
Z2715/466177-015	Penny
Z2716/466177-016	Butterscotch
Z2717/466177-017	Harvest
Z2718/466177-018	Lioness
Z2719/466177-019	Caper
Z2720/466177-020	Parakeet
Z2721/466177-021	Greenway
Z2722/466177-022	Aquatic
Z2723/466177-023	Cottage
Z2724/466177-024	Dahlia
Z2725/466177-025	Vivid
Z2726/466177-026	Basin
Z2727/466177-027	Schooner

Metric – Maharam	
54" wide	
51% recycled polyester	
49% polyester	
Z301/466014-001	Phantom
Z302/466014-002	Fog
Z303/466014-003	Fleece
Z304/466014-004	Sourdough
Z305/466014-005	Toffee
Z306/466014-006	Driftwood
Z307/466014-007	Mineral
Z308/466014-008	Bittersweet
Z309/466014-009	Arabica
Z310/466014-010	Cerise
Z311/466014-011	Brick
Z312/466014-012	Cardinal
Z313/466014-013	Lava
Z314/466014-014	Oriole
Z315/466014-015	Cedar
Z317/466014-017	Caramel
Z318/466014-018	Pollen
Z319/466014-019	Tupelo
Z320/466014-020	Alligator
Z321/466014-021	Envy
Z322/466014-022	Bonsai
Z323/466014-023	Tar
Z324/466014-024	Anchor
Z325/466014-025	Twilight
Z326/466014-026	Admiral
Z327/466014-027	Seaport
Z328/466014-028	Scuba

Price Category D

Mode – Maharam	
54" wide	
80% post-consumer recycled polyester	
20% polyester	
PFOA-Free stain resistant finish	
ZMD01/466337-001	Stroll
ZMD02/466337-002	Intaglio
ZMD03/466337-003	Ominous
ZMD04/466337-004	Machine
ZMD05/466337-005	Talus
ZMD06/466337-006	Marsh
ZMD07/466337-007	Hollow
ZMD08/466337-008	Sycamore
ZMD09/466337-009	Clavicle
ZMD10/466337-010	Billygoat
ZMD11/466337-011	Spindle
ZMD12/466337-012	Lemon
ZMD13/466337-013	Oxeye
ZMD14/466337-014	Henge
ZMD15/466337-015	Goldenrod
ZMD16/466337-016	Cottontail
ZMD17/466337-017	Lioness
ZMD18/466337-018	Oriole
ZMD19/466337-019	Rust
ZMD20/466337-020	Carotene
ZMD21/466337-021	Blush
ZMD22/466337-022	Vermillion
ZMD23/466337-023	Alder
ZMD24/466337-024	Kermes
ZMD25/466337-025	Barberry
ZMD26/466337-026	Petal
ZMD27/466337-027	Valley
ZMD28/466337-028	Odyssey
ZMD29/466337-029	Ballpoint
ZMD30/466337-030	Toile
ZMD31/466337-031	Paradise
ZMD32/466337-032	Angelfish
ZMD33/466337-033	Denim

Price category D continued on next page

- Maharam textiles are on assigned lead times A unless otherwise noted.
- Fabric numbers are listed as Herman Miller fabric number/Maharam fabric number.

Maharam® Colors — Seating

continued

Price Category D

continued

Mode continued

ZMD34/466337-034	Crush
ZMD35/466337-035	Jetty
ZMD36/466337-036	Saltwater
ZMD37/466337-037	Mallard
ZMD38/466337-038	Celtic
ZMD39/466337-039	Eucalyptus
ZMD40/466337-040	Bonsai
ZMD41/466337-041	Sassafras
ZMD42/466337-042	Yucca
ZMD43/466337-043	Lichen

Focus - Maharam

57" wide	
54% post-industrial recycled polyester	
33% polyester	
13% post-consumer recycled polyester	
ZFS01/465910-001	Ivory
ZFS02/465910-002	Allow
ZFS04/465910-004	Lichen
ZFS06/465910-006	Sierra
ZFS07/465910-007	Merlot
ZFS08/465910-008	Clove
ZFS09/465910-009	Carbon
ZFS10/465910-010	Regatta
ZFS11/465910-011	Emerald

Ledger – Maharam

54" wide	
100% polyurethane	
V9G1/463770-001	001
V9G2/463770-002	002
V9G3/463770-003	003
V9G4/463770-004	004
V9G6/463770-006	006
V9G7/463770-007	007
V9GG/463770-017	017
V9GH/463770-018	018
V9GJ/463770-019	019
V9GM/463770-022	022
V9GQ/463770-025	025
V9GS/463770-026	026
V9GU/463770-028	028
V9GV/463770-029	029
V9GW/463770-030	030
V9GX/463770-031	031
V9GY/463770-032	032
V9GZ/463770-033	033
V9G10/463770-034	034
V9G11/463770-035	035
V9G12/463770-036	036
V9G13/463770-037	037
V9G14/463770-038	038

.....

Ledger continued

V9G15/463770-039	039
V9G16/463770-040	040
V9G17/463770-041	041
V9G18/463770-042	042
V9G19/463770-043	043
V9G20/463770-044	044
V9G21/463770-045	045
V9G22/463770-046	046

Oblique - Maharam

58" wide	
100% polyester	
with stain resistant finish	
ZBQ01/466222-001	001
ZBQ02/466222-002	002
ZBQ03/466222-003	003
ZBQ04/466222-004	004
ZBQ05/466222-005	005
ZBQ06/466222-006	006
ZBQ07/466222-007	007

Pick - Maharam

58" wide	
100% polyester	
with stain resistant finish	
ZP201/466224-001	001
ZP202/466224-002	002
ZP203/466224-003	003
ZP204/466224-004	004
ZP205/466224-005	005
ZP206/466224-006	006
ZP207/466224-007	007
ZP208/466224-008	008
ZP209/466224-009	009
ZP210/466224-010	010

.....

Skein - Maharam

54" wide	
56% recycled polyester	
44% polyester	
Z3201/466170-001	Burrow
Z3204/466170-004	Sumac
Z3205/466170-005	Pomegranate
Z3206/466170-006	Cavern
Z3207/466170-007	Bitter
Z3208/466170-008	Cinder
Z3209/466170-009	Dock
Z3210/466170-010	Cadet
Z3211/466170-011	Marsh

Technic - Maharam

56" wide	
60% post-industrial recycled polyester	
40% post-consumer recycled polyester	
PFOA-Free stain resistant finish	
Acrylic backing	
ZT301/466226-001	Cumin
ZT302/466226-002	Evergreen
ZT303/466226-003	Cobalt
ZT304/466226-004	Bear
ZT305/466226-005	Squirrel

.....

- Maharam textiles are on assigned lead times **A** unless otherwise noted.
- Fabric numbers are listed as Herman Miller fabric number/Maharam fabric number.

Maharam® Colors — Seating

continued

Price Category F

Chock - Maharam	
59" wide	
36% rayon	
35% cotton	
29% solution-dyed post-industrial recycled nylon	
PFOA-Free stain resistant finish	
Acrylic backing	
ZCH01/466219-001	Beige
ZCH02/466219-002	Stone
ZCH03/466219-003	Brown
ZCH04/466219-004	Red
ZCH05/466219-005	Copper
ZCH07/466219-007	Smoke
ZCH08/466219-008	Ebony

Coin - Maharam	
57" wide	
43% polyester	
37% post-industrial recycled polyester	
20% post-consumer recycled polyester	
PFOA-Free stain resistant finish	
Acrylic backing	
ZC801/466233-001	Nickel
ZC802/466233-002	Diner
ZC803/466233-003	Copper
ZC804/466233-004	Maroon
ZC805/466233-005	Penny
ZC806/466233-006	Exchange
ZC807/466233-007	Lead

Coincide - Maharam	
54" wide	
100% polyester	
ZCJ01/465808-001	Mist
ZCJ02/465808-002	Drizzle
ZCJ03/465808-003	Cicada
ZCJ04/465808-004	Bungalow
ZCJ05/465808-005	Aurora
ZCJ06/465808-006	Currant
ZCJ07/465808-007	Raisin
ZCJ08/465808-008	Tranquil
ZCJ09/465808-009	Caribbean
ZCJ10/465808-010	Woodland
ZCJ11/465808-011	Acre

Crush - Maharam	
54" wide	
85% solution-dyed nylon	
13% polyester	
2% polyolefin	
VS01/464780-001	001
VS02/464780-002	002
VS05/464780-005	005
VS08/464780-008	008
VS13/464780-013	013
VS16/464780-016	016
VS17/464780-017	017
VS18/464780-018	018
VS19/464780-019	019
VS20/464780-020	020
VS22/464780-022	022
VS23/464780-023	023
VS26/464780-026	026
VS27/464780-027	027

Disc - Maharam	
57" wide	
100% polyester	
PFOA-Free stain resistant finish	
Acrylic backing	
ZD101/466221-001	Nude
ZD102/466221-002	Khaki
ZD103/466221-003	Festive
ZD104/466221-004	Vibrant
ZD105/466221-005	Somber
ZD106/466221-006	Warm
ZD107/466221-007	Steel

Divide - Maharam	
57" wide	
45% polyester	
36% post-industrial recycled polyester	
19% post-consumer recycled polyester	
PFOA-Free stain resistant finish	
Acrylic backing	
ZD301/466220-001	Ecru
ZD302/466220-002	Café
ZD303/466220-003	Concrete
ZD304/466220-004	Forest
ZD305/466220-005	Tropic
ZD306/466220-006	Lagoon
ZD307/466220-007	Mocha
ZD308/466220-008	Singe
ZD309/466220-009	Cayenne

Exchange - Maharam	
58" wide	
58% post-industrial recycled polyester	
42% post-consumer recycled polyester	
ZEE01/466027-001	Cinder
ZEE02/466027-002	Sable
ZEE04/466027-004	Gull
ZEE06/466027-006	Coastline
ZEE07/466027-007	Clay
ZEE08/466027-008	Buck
ZEE10/466027-010	Rhubarb
ZEE11/466027-011	Punch

Plait - Maharam	
58" wide	
68% recycled polyester	
32% polyester	
Z2901/466052-001	Cobblestone
Z2902/466052-002	Sachet
Z2903/466052-003	Mesa
Z2904/466052-004	Tavern
Z2905/466052-005	Sequoia
Z2906/466052-006	Rhubarb
Z2907/466052-007	Sangria
Z2908/466052-008	Reef
Z2909/466052-009	Stormy
Z2910/466052-010	Dapper

Remix - Maharam	
54" wide	
90% wool	
10% nylon	
V2601/465956-113	113
V2602/465956-123	123
V2603/465956-133	133
V2604/465956-143	143
V2605/465956-152	152
V2606/465956-163	163
V2607/465956-173	173
V2608/465956-183	183
V2609/465956-223	223
V2610/465956-233	233
V2611/465956-242	242
V2612/465956-252	252
V2613/465956-362	362
V2614/465956-373	373
V2615/465956-383	383
V2616/465956-393	393
V2617/465956-412	412
V2618/465956-422	422
V2619/465956-433	433
V2620/465956-443	443
V2621/465956-452	452
V2622/465956-543	543
V2623/465956-612	612

Price category F continued on next page

- Maharam textiles are on assigned lead times ^A unless otherwise noted.
- Fabric numbers are listed as Herman Miller fabric number/Maharam fabric number.

Maharam® Colors — Seating

continued

Price Category F

continued

Remix continued	
V2624/465956-632	632
V2625/465956-643	643
V2626/465956-653	653
V2627/465956-662	662
V2628/465956-672	672
V2629/465956-682	682
V2630/465956-692	692
V2631/465956-722	722
V2632/465956-733	733
V2633/465956-743	743
V2634/465956-753	753
V2635/465956-762	762
V2636/465956-773	773
V2637/465956-783	783
V2638/465956-823	823
V2639/465956-842	842
V2640/465956-852	852
V2641/465956-873	873
V2642/465956-912	912
V2643/465956-923	923
V2644/465956-933	933
V2645/465956-942	942
V2646/465956-962	962
V2647/465956-973	973
V2648/465956-982	982
V2649/465956-954	954

Rove - Maharam	
54" wide	
100% solution-dyed polyolefin with silver-based antimicrobial	
ZRV01/466096-001	Rice
ZRV02/466096-002	Soba
ZRV03/466096-003	Owl
ZRV04/466096-004	Till
ZRV05/466096-005	Dijon
ZRV06/466096-006	Mum
ZRV07/466096-007	Nasturtium
ZRV08/466096-008	Vixen
ZRV09/466096-009	Roast
ZRV10/466096-010	Llama
ZRV11/466096-011	Rind
ZRV12/466096-012	Grackle
ZRV13/466096-013	Indigo
ZRV14/466096-014	Drip
ZRV15/466096-015	Neptunia
ZRV16/466096-016	Pomelo
ZRV17/466096-017	Fairy

Runner Standard - Maharam	
58" wide	
57% post-industrial recycled polyester	
43% post-consumer recycled polyester	
ZRA07/466167-007	Bluff
ZRA08/466167-008	Arid
ZRA09/466167-009	Grove
ZRA10/466167-010	Starboard
ZRA11/466167-011	Plot
ZRA12/466167-012	Carousel

Seam - Maharam	
54" wide	
100% polyester	
PFOA-Free stain resistant finish	
Acrylic backing	
ZSM01/466289-001	Reed
ZSM02/466289-002	Console
ZSM03/466289-003	Play
ZSM04/466289-004	Jock
ZSM05/466289-005	Engine
ZSM06/466289-006	Haunted
ZSM07/466289-007	Transmit
ZSM08/466289-008	Spark
ZSM09/466289-009	Storm
ZSM10/466289-010	Tunnel

Sequence - Maharam	
54" wide	
100% solution-dyed polyolefin with silver-based antimicrobial	
Z3101/466179-001	Driftwood
Z3102/466179-002	Boardwalk
Z3103/466179-003	Rattan
Z3104/466179-004	Alfresco
Z3105/466179-005	Plunge
Z3106/466179-006	Starboard
Z3107/466179-007	Veranda
Z3108/466179-008	Lodge
Z3109/466179-009	Flare

Shuttle Standard - Maharam	
54" wide	
84% post-industrial recycled polyester	
16% post-consumer recycled polyester	
ZSS16/466168-016	Clam
ZSS17/466168-017	Plateau
ZSS18/466168-018	Shoal

Strum - Maharam	
54" wide	
100% polyurethane with silver-based antimicrobial	
Z3301/466122-001	Overcast
Z3302/466122-002	Ridge
Z3303/466122-003	Twilight
Z3304/466122-004	Pigeon
Z3305/466122-005	Char
Z3306/466122-006	Cabin
Z3307/466122-007	Bur
Z3308/466122-008	Abalone
Z3309/466122-009	Prawn
Z3310/466122-010	Gourd
Z3311/466122-011	Wheat
Z3312/466122-012	Lemongrass

Waxen - Maharam	
54" wide	
100% polyester	
ZWX01/466078-001	Appear
ZWX03/466078-003	Savanna
ZWX05/466078-005	Frozen
ZWX06/466078-006	Highland
ZWX07/466078-007	Patina
ZWX10/466078-010	Ruby
ZWX11/466078-011	Ember
ZWX12/466078-012	Harvest
ZWX14/466078-014	Fresh
ZWX16/466078-016	Jay
ZWX17/466078-017	Gazer
ZWX19/466078-019	Bayou

- Maharam textiles are on assigned lead times **A** unless otherwise noted.
- Fabric numbers are listed as Herman Miller fabric number/Maharam fabric number.

Maharam® Colors — Seating

continued

Price Category G

Coin Crypton - Maharam	
54" wide	
43% polyester	
37% post-industrial recycled polyester	
20% post-consumer recycled polyester	
Crypton Green finish and backing	
ZC901/466236-001	Nickel
ZC902/466236-002	Diner
ZC903/466236-003	Copper
ZC904/466236-004	Maroon
ZC905/466236-005	Penny
ZC906/466236-006	Exchange
ZC907/466236-007	Lead

Coincide High Performance-Maharam	
54" wide	
100% polyester	
ZCF02/466132-002	Drizzle
ZCF03/466132-003	Cicada
ZCF04/466132-004	Bungalow
ZCF07/466132-007	Raisin
ZCF10/466132-010	Woodland
ZCF11/466132-011	Acre

Colline - Maharam	
55" wide	
75% wool	
17% acrylic	
8% nylon	
ZCQ01/466155-108	108
ZCQ02/466155-118	118
ZCQ03/466155-148	148
ZCQ04/466155-188	188
ZCQ05/466155-228	228
ZCQ06/466155-348	348
ZCQ07/466155-448	448
ZCQ08/466155-548	548
ZCQ09/466155-568	568
ZCQ10/466155-668	668
ZCQ11/466155-688	688
ZCQ12/466155-788	788

Compound - Maharam	
54" wide	
100% polyurethane	
silane-based antimicrobial	
ZC201/466196-001	001
ZC202/466196-002	002
ZC203/466196-003	003
ZC204/466196-004	004
ZC205/466196-005	005
ZC206/466196-006	006
ZC207/466196-007	007
ZC208/466196-008	008
ZC209/466196-009	009
ZC210/466196-010	010
ZC211/466196-011	011
ZC212/466196-012	012
ZC213/466196-013	013
ZC214/466196-014	014
ZC215/466196-015	015
ZC216/466196-016	016
ZC217/466196-017	017
ZC218/466196-018	018
ZC219/466196-019	019

Disc Crypton - Maharam	
57" wide	
100% polyester	
Crypton finish and backing	
ZD204/466237-004	Vibrant
ZD205/466237-005	Somber
ZD207/466237-007	Steel

Divide Crypton - Maharam	
57" wide	
45% polyester	
36% post-industrial recycled polyester	
19% post-consumer recycled polyester	
Crypton Green finish and backing	
ZD401/466238-001	Ecru
ZD402/466238-002	Café
ZD403/466238-003	Concrete
ZD404/466238-004	Forest
ZD405/466238-005	Tropic
ZD406/466238-006	Lagoon
ZD407/466238-007	Mocha
ZD408/466238-008	Singe

Divina MD - Maharam	
59" wide	
100% wool	
Z2301/466150-193	193
Z2302/466150-203	203
Z2303/466150-213	213
Z2304/466150-293	293
Z2305/466150-343	343
Z2306/466150-353	353
Z2307/466150-363	363
Z2308/466150-413	413
Z2309/466150-433	433
Z2310/466150-453	453
Z2311/466150-613	613
Z2312/466150-633	633
Z2313/466150-653	653
Z2314/466150-673	673
Z2315/466150-683	683
Z2316/466150-713	713
Z2317/466150-733	733
Z2318/466150-743	743
Z2319/466150-753	753
Z2320/466150-773	773
Z2321/466150-783	783
Z2322/466150-813	813
Z2323/466150-843	843
Z2324/466150-873	873
Z2325/466150-913	913
Z2326/466150-943	943
Z2327/466150-973	973

Divina - Maharam	
59" wide	
100% wool	
TF01/460730-154	154
TF03/460730-171	171
TF04/460730-173	173
TF05/460730-181	181
TF06/460730-191	191
TF08/460730-224	224
TF10/460730-334	334
TF13/460730-384	384
TF14/460730-393	393
TF16/460730-444	444
TF17/460730-462	462
TF18/460730-542	542

- Maharam textiles are on assigned lead times ^A unless otherwise noted.
- Fabric numbers are listed as Herman Miller fabric number/Maharam fabric number.

Price category G continued on next page

Maharam® Colors — Seating

continued

Price Category G

continued

Divina continued	
TF19/460730-552	552
TF20/460730-562	562
TF22/460730-584	584
TF23/460730-623	623
TF25/460730-652	652
TF26/460730-662	662
TF27/460730-671	671
TF29/460730-684	684
TF30/460730-691	691
TF31/460730-692	692
TF33/460730-712	712
TF37/460730-742	742
TF41/460730-782	782
TF42/460730-791	791
TF43/460730-793	793
TF47/460730-893	893
TF49/460730-922	922
TF51/460730-944	944
TF53/460730-984	984
TF55/460730-106	106
TF56/460730-236	236
TF57/460730-246	246
TF58/460730-346	346
TF59/460730-356	356
TF60/460730-376	376
TF61/460730-426	426
TF62/460730-526	526
TF63/460730-536	536
TF64/460730-626	626
TF65/460730-636	636
TF66/460730-666	666
TF67/460730-676	676
TF68/460730-686	686
TF69/460730-696	696
TF70/460730-756	756
TF71/460730-826	826
TF72/460730-836	836
TF73/460730-846	846
TF74/460730-856	856
TF75/460730-876	876
TF76/460730-886	886
TF77/460730-936	936
TF78/460730-956	956
TF79/460730-966	966

Divina Melange — Maharam	
59" wide	
100% wool	
TG01/460830-120	120
TG02/460830-170	170
TG03/460830-180	180
TG04/460830-220	220
TG05/460830-260	260
TG06/460830-280	280
TG07/460830-871	871
TG08/460830-821	821
TG09/460830-771	771
TG10/460830-721	721
TG11/460830-731	731
TG12/460830-681	681
TG13/460830-631	631
TG15/460830-671	671
TG16/460830-581	581
TG17/460830-531	531
TG18/460830-521	521
TG19/460830-571	571
TG20/460830-421	421
TG21/460830-471	471
TG22/460830-931	931
TG24/460830-971	971
TG25/460830-925	925
TG26/460830-620	620

Emboss - Maharam	
54" wide	
100% polyurethane	
Polyester backing	
ZEM01/466281-001	Bronze
ZEM02/466281-002	Brass
ZEM03/466281-003	Gold
ZEM04/466281-004	Platinum
ZEM05/466281-005	Silver
ZEM06/466281-006	Aqua
ZEM07/466281-007	Aegean
ZEM08/466281-008	Cobalt
ZEM09/466281-009	Ultraviolet
ZEM10/466281-010	Copper
ZEM11/466281-011	Molten

Fold - Maharam	
54" wide	
100% polyurethane	
Polyester backing	
ZF101/466292-001	Jet
ZF102/466292-002	Chalk
ZF103/466292-003	Smoke
ZF104/466292-004	Putty
ZF105/466292-005	Fatigue
ZF106/466292-006	Splash
ZF107/466292-007	Apple
ZF108/466292-008	Moss
ZF109/466292-009	Graphite
ZF110/466292-010	Midnight

Hero by Kvadrat - Maharam	
55" wide	
96% wool	
4% nylon	
ZH101/466318-101	101
ZH102/466318-141	141
ZH103/466318-151	151
ZH104/466318-181	181
ZH105/466318-191	191
ZH106/466318-201	201
ZH107/466318-211	211
ZH108/466318-231	231
ZH109/466318-311	311
ZH110/466318-381	381
ZH111/466318-411	411
ZH112/466318-441	441
ZH113/466318-451	451
ZH114/466318-481	481
ZH115/466318-511	511
ZH116/466318-541	541
ZH117/466318-551	551
ZH118/466318-601	601
ZH119/466318-681	681
ZH120/466318-701	701
ZH121/466318-711	711

Hero by Kvadrat continued	
ZH122/466318-751	751
ZH123/466318-791	791
ZH124/466318-901	901
ZH125/466318-931	931
ZH126/466318-941	941
ZH127/466318-981	981
ZH128/466318-991	991

Omen - Maharam	
54" wide	
75% polyester	
16% post-industrial recycled polyester	
9% post-consumer recycled polyester	
ZQM01/466172-001	Clam
ZQM02/466172-002	Pewter
ZQM03/466172-003	Hazel
ZQM04/466172-004	Grain
ZQM05/466172-005	Bundle
ZQM07/466172-007	Glacier
ZQM08/466172-008	Surf
ZQM09/466172-009	Wade
ZQM10/466172-010	Marble
ZQM11/466172-011	Silt
ZQM12/466172-012	Persimmon
ZQM13/466172-013	Rocket

Pick Crypton - Maharam	
54" wide	
100% polyester	
Crypton finish and backing	
ZP102/466235-002	Olive
ZP103/466235-003	Slate
ZP104/466235-004	Espresso
ZP105/466235-005	Pepper
ZP106/466235-006	Masala
ZP107/466235-007	Fresh
ZP108/466235-008	Cool
ZP109/466235-009	Ink
ZP110/466235-010	Jet

Price category G continued on next page

- Maharam textiles are on assigned lead times **A** unless otherwise noted.
- Fabric numbers are listed as Herman Miller fabric number/Maharam fabric number.

Maharam® Colors — Seating

continued

Price Category G

continued

Pocket - Maharam	
54" wide	
76% recycled polyester	
24% nylon	
ZP301/466243-001	001
ZP302/466243-002	002
ZP303/466243-003	003
ZP304/466243-004	004
ZP305/466243-005	005
ZP306/466243-006	006
ZP307/466243-007	007

Ring - Maharam	
54" wide	
48% polyester	
34% post-industrial recycled polyester	
18% post-consumer recycled polyester	
ZRG02/466182-002	Flax
ZRG04/466182-004	Black
ZRG05/466182-005	Scarlet
ZRG06/466182-006	Rust
ZRG07/466182-007	Green
ZRG09/466182-009	Royal

Runner - Maharam	
54" wide	
57% post-industrial recycled polyester	
43% post-consumer recycled polyester	
ZRF01/466108-001	Bluff
ZRF02/466108-002	Arid
ZRF03/466108-003	Grove
ZRF04/466108-004	Starboard
ZRF05/466108-005	Plot
ZRF06/466108-006	Carousel

Sheen - Maharam	
54" wide	
100% polyurethane with silane-based antimicrobial	
ZSN01/466246-001	Sail
ZSN02/466246-002	Silver
ZSN03/466246-003	Pewter
ZSN04/466246-004	Hearth
ZSN05/466246-005	Fern
ZSN06/466246-006	Bog
ZSN07/466246-007	Cricket
ZSN08/466246-008	Clove
ZSN09/466246-009	Mystic
ZSN10/466246-010	Vat
ZSN11/466246-011	Huckleberry
ZSN12/466246-012	Mauve
ZSN13/466246-013	Brick
ZSN14/466246-014	Ruby
ZSN15/466246-015	Dragon
ZSN16/466246-016	Kumquat
ZSN17/466246-017	Cinnamon
ZSN18/466246-018	Alder

Steelcut - Maharam	
55" wide	
90% wool	
10% nylon	
ZSE01/464470-110	110
ZSE02/464470-120	120
ZSE03/464470-135	135
ZSE04/464470-140	140
ZSE05/464470-155	155
ZSE06/464470-160	160
ZSE07/464470-180	180
ZSE08/464470-190	190
ZSE09/464470-220	220
ZSE10/464470-240	240
ZSE11/464470-255	255
ZSE12/464470-265	265
ZSE13/464470-365	365
ZSE14/464470-370	370
ZSE15/464470-380	380
ZSE16/464470-435	435
ZSE17/464470-445	445
ZSE18/464470-535	535
ZSE19/464470-545	545
ZSE20/464470-550	550
ZSE21/464470-605	605
ZSE22/464470-615	615
ZSE23/464470-625	625
ZSE24/464470-635	635
ZSE25/464470-655	655
ZSE26/464470-660	660
ZSE27/464470-685	685
ZSE28/464470-695	695
ZSE29/464470-760	760
ZSE30/464470-775	775
ZSE31/464470-780	780
ZSE32/464470-820	820
ZSE33/464470-835	835
ZSE34/464470-935	935
ZSE35/464470-950	950
ZSE36/464470-975	975
ZSE37/464470-985	985

Steelcut Trio - Maharam	
55" wide	
90% wool	
10% nylon	
V2501/465906-105	105
V2502/465906-113	113
V2503/465906-124	124
V2504/465906-133	133
V2506/465906-153	153
V2507/465906-195	195
V2508/465906-205	205
V2509/465906-213	213
V2513/465906-253	253
V2514/465906-283	283
V2518/465906-383	383
V2523/465906-453	453
V2525/465906-515	515
V2526/465906-533	533
V2527/465906-553	553
V2529/465906-645	645
V2534/465906-713	713
V2542/465906-865	865
V2543/465906-883	883
V2544/465906-915	915
V2545/465906-933	933
V2546/465906-945	945
V2547/465906-953	953
V2548/465906-965	965
V2549/465906-983	983
V2550/465906-176	176
V2551/465906-226	226
V2552/465906-236	236
V2553/465906-246	246
V2554/465906-266	266
V2555/465906-276	276
V2556/465906-336	336
V2557/465906-376	376
V2558/465906-416	416
V2559/465906-426	426
V2560/465906-436	436
V2561/465906-446	446

Appendix: Maharam Colors — Seating

Price category G continued on next page

- Maharam textiles are on assigned lead times A unless otherwise noted.
- Fabric numbers are listed as Herman Miller fabric number/Maharam fabric number.

Maharam® Colors — Seating

continued

Price Category G

continued

Steelcut Trio <i>continued</i>	
V2562/465906-466	466
V2563/465906-476	476
V2564/465906-506	506
V2565/465906-526	526
V2566/465906-576	576
V2567/465906-616	616
V2568/465906-636	636
V2569/465906-666	666
V2570/465906-686	686
V2571/465906-716	716
V2572/465906-746	746
V2573/465906-756	756
V2574/465906-776	776
V2575/465906-796	796
V2576/465906-806	806
V2577/465906-906	906
V2578/465906-916	916
V2579/465906-946	946
V2580/465906-966	966
V2581/465906-976	976
V2582/465906-996	996

Stride - Maharam	
58" wide	
40% post-industrial recycled polyester	
39% polyester	
21% post-consumer recycled polyester	
PFOA-Free stain resistant finish	
Acrylic backing	
ZS103/466252-003	Midnight
ZS104/466252-004	Moss
ZS106/466252-006	Ember

Ticker - Maharam	
54" wide	
47% polyester	
31% post-industrial recycled polyester	
22% post-consumer recycled polyester	
Crypton green finish and backing	
ZT401/466304-001	Calm
ZT402/466304-002	Millet
ZT403/466304-003	Sow
ZT404/466304-004	Beaver
ZT405/466304-005	Patch
ZT406/466304-006	Balloon
ZT407/466304-007	Squad
ZT408/466304-008	Bale
ZT409/466304-009	Fecund
ZT410/466304-010	Aquarium
ZT411/466304-011	Drink
ZT412/466304-012	Depth
ZT413/466304-013	Far

Vestige - Maharam	
54" wide	
71% polyester	
29% rayon	
ZVT01/466259-001	001
ZVT02/466259-002	002
ZVT03/466259-003	003
ZVT04/466259-004	004
ZVT05/466259-005	005
ZVT06/466259-006	006
ZVT07/466259-007	007
ZVT08/466259-008	008
ZVT09/466259-009	009
ZVT10/466259-010	010

Price Category H

Circles — Maharam	
55" wide	
70% cotton	
30% polyester	
ZT01/458310-001	Khaki
ZT02/458310-002	Fatigue
ZT03/458310-003	Document
ZT04/458310-004	Engine
ZT05/458310-005	Charcoal

Crosspatch — Maharam	
54" wide	
75% rayon	
25% polyester	
ZS01/458920-001	Song
ZS02/458920-002	Fresh
ZS04/458920-004	Document
ZS06/458920-006	Circus
ZS08/458920-008	Grounded

Ditto — Maharam	
54" wide	
77% recycled polyester	
23% solution dyed nylon	
Z2D1/465993-001	Nacre
Z2D2/465993-002	Shadow
Z2D3/465993-003	Saddle
Z2D9/465993-009	Fern
Z2DA/465993-010	Fountain
Z2DB/465993-011	Cobalt
Z2DC/465993-012	Iron
Z2DD/465993-013	Driftwood

Dot Pattern — Maharam	
55" wide	
71% cotton	
29% polyester	
ZK01/458300-001	Document
ZK02/458300-002	Taupe
ZK04/458300-004	Red
ZK05/458300-005	Navy

Hallingdal - Maharam	
51" wide	
70% wool	
30% rayon	
Z2401/460760-100	100
Z2402/460760-103	103
Z2403/460760-110	110
Z2404/460760-113	113
Z2405/460760-116	116
Z2406/460760-123	123
Z2407/460760-126	126
Z2408/460760-130	130
Z2409/460760-143	143
Z2410/460760-153	153
Z2411/460760-166	166
Z2412/460760-173	173
Z2413/460760-180	180
Z2414/460760-190	190
Z2415/460760-200	200
Z2416/460760-220	220
Z2417/460760-224	224
Z2418/460760-227	227
Z2419/460760-270	270
Z2420/460760-350	350
Z2421/460760-368	368
Z2422/460760-370	370
Z2423/460760-376	376
Z2424/460760-390	390
Z2425/460760-407	407
Z2426/460760-420	420
Z2427/460760-457	457
Z2428/460760-526	526
Z2429/460760-547	547
Z2430/460760-563	563
Z2431/460760-573	573
Z2432/460760-590	590
Z2433/460760-596	596
Z2434/460760-600	600
Z2435/460760-657	657
Z2436/460760-660	660
Z2437/460760-674	674
Z2438/460760-680	680
Z2439/460760-687	687

Price category H continued on next page

- Maharam textiles are on assigned lead times **A** unless otherwise noted.
- Fabric numbers are listed as Herman Miller fabric number/Maharam fabric number.

Maharam® Colors — Seating

continued

Price Category H

continued

Hallingdal continued

Z2440/460760-694	694
Z2441/460760-702	702
Z2442/460760-723	723
Z2443/460760-733	733
Z2444/460760-750	750
Z2445/460760-753	753
Z2446/460760-754	754
Z2447/460760-763	763
Z2448/460760-764	764
Z2449/460760-773	773
Z2450/460760-810	810
Z2451/460760-840	840
Z2452/460760-850	850
Z2453/460760-890	890
Z2454/460760-907	907
Z2455/460760-944	944
Z2456/460760-960	960
Z2457/460760-968	968
Z2458/460760-980	980

Offset — Maharam

54" wide	
40% cotton	
36% nylon	
24% wool	
ZQF01/465951-001	Passage
ZQF02/465951-002	Fieldstone
ZQF03/465951-003	Coast
ZQF04/465951-004	Esplanade
ZQF05/465951-005	Oasis
ZQF06/465951-006	Spice
ZQF07/465951-007	Bloom

Small Dot Pattern — Maharam

55" wide	
71% cotton	
29% polyester	
ZL01/458320-001	Document
ZL02/458320-002	Sand
ZL03/458320-003	Khaki
ZL04/458320-004	Taupe
ZL05/458320-005	Charcoal
ZL06/458320-006	Document
Reverse	
ZL07/458320-007	Red
ZL08/458320-008	Yellow
ZL09/458320-009	Green

Tonus - Maharam

51" wide	
90% wool	
10% helanka	
ZTN01/460800-100	100
ZTN03/460800-109	109
ZTN05/460800-118	118
ZTN10/460800-125	125
ZTN13/460800-128	128
ZTN14/460800-129	129
ZTN15/460800-130	130
ZTN16/460800-131	131
ZTN17/460800-132	132
ZTN19/460800-135	135
ZTN21/460800-207	207
ZTN23/460800-210	210
ZTN26/460800-216	216
ZTN27/460800-240	240
ZTN29/460800-440	440
ZTN32/460800-508	508

Tonus continued

ZTN34/460800-605	605
ZTN35/460800-608	608
ZTN36/460800-609	609
ZTN37/460800-610	610
ZTN38/460800-613	613
ZTN40/460800-615	615
ZTN41/460800-619	619
ZTN51/460800-631	631
ZTN54/460800-634	634
ZTN56/460800-636	636
ZTN59/460800-690	690
ZTN62/460800-840	840
ZTN63/460800-940	940
ZTN65/460800-224	224
ZTN66/460800-244	244
ZTN67/460800-364	364
ZTN68/460800-374	374
ZTN69/460800-394	394
ZTN70/460800-424	424
ZTN71/460800-454	454
ZTN72/460800-464	464
ZTN73/460800-474	474
ZTN74/460800-554	554
ZTN75/460800-654	654
ZTN76/460800-664	664
ZTN77/460800-684	684
ZTN78/460800-754	754
ZTN79/460800-764	764
ZTN80/460800-854	854
ZTN81/460800-914	914
ZTN82/460800-934	934
ZTN83/460800-954	954
ZTN84/460800-964	964
ZTN85/460800-974	974

Price Category I

Latch - Maharam

55" wide	
61% cotton	
39% solution-dyed post-industrial recycled nylon	
16% rayon	
PFOA-Free stain resistant finish	
Acrylic backing	
ZLC01/466301-001	Rescue
ZLC02/466301-002	Guide
ZLC03/466301-003	Rotary
ZLC04/466301-004	Radar
ZLC05/466301-005	Sphere
ZLC06/466301-006	Solemn

Teatro - Maharam

55" wide	
100% polyester	
Polyester/Cotton backing	
ZT201/466309-001	Crumb
ZT202/466309-002	Dorper
ZT203/466309-003	Herd
ZT204/466309-004	Deep
ZT205/466309-005	Robe
ZT206/466309-006	Heat
ZT207/466309-007	Caspian
ZT208/466309-008	Misty
ZT209/466309-009	Boulder
ZT210/466309-010	Elixir
ZT211/466309-011	Guard
ZT212/466309-012	Throne

- Maharam textiles are on assigned lead times A unless otherwise noted.
- Fabric numbers are listed as Herman Miller fabric number/Maharam fabric number.

Maharam® Colors — Seating

continued

Appendix: Maharam Colors — Seating

Price Category J	Price Category K	Price Category L	Price Category M
Tokyo - Maharam 59" wide 67% wool 24% polyester 9% nylon ZT101/466247-112 112 ZT102/466247-132 132 ZT103/466247-182 182 ZT104/466247-242 242 ZT105/466247-252 252 ZT106/466247-352 352 ZT107/466247-432 432 ZT108/466247-632 632 ZT109/466247-652 652 ZT110/466247-682 682 ZT111/466247-692 692 ZT112/466247-732 732 ZT113/466247-782 782 ZT114/466247-952 952 ZT115/466247-982 982	Coda by Kvadrat - Maharam 55" wide 90% wool 10% nylon ZC701/464480-100 100 ZC702/464480-103 103 ZC703/464480-116 116 ZC704/464480-182 182 ZC705/464480-222 222 ZC706/464480-232 232 ZC707/464480-242 242 ZC708/464480-362 362 ZC709/464480-382 382 ZC710/464480-410 410 ZC711/464480-422 422 ZC712/464480-442 442 ZC713/464480-610 610 ZC714/464480-632 632 ZC715/464480-642 642 ZC716/464480-722 722 ZC717/464480-762 762 ZC718/464480-962 962	Minicheck - Maharam 55" wide 78% cotton 22% polyester PFOA-Free stain resistant finish ZMK01/466268-001 Black/White	Fruit - Maharam 54" wide 55% cotton 32% nylon 13% post-consumer recycled polyester PFOA-Free stain resistant finish Acrylic backing ZF201/466262-001 Opal ZF202/466262-002 Lime ZF203/466262-003 Olive ZF204/466262-004 Sky ZF205/466262-005 Kernal ZF206/466262-006 Droplet ZF207/466262-007 Russet

- Maharam textiles are on assigned lead times A unless otherwise noted.
- Fabric numbers are listed as Herman Miller fabric number/Maharam fabric number.

Maharam® Colors — Seating

continued

Price Category N-Z

No fabrics available at this time.

- Maharam textiles are on assigned lead times **A** unless otherwise noted.
- Fabric numbers are listed as Herman Miller fabric number/Maharam fabric number.

For more information about our products and services or to see a list of dealers, please visit us at HermanMiller.com or call (800) 851 1196.

© 2018 Herman Miller, Inc., Zeeland, Michigan

® **HermanMiller**, 3D Intelligent, AO, Action Office, Aeron, ArcSpan, Aside, Avall, Avive, Bubble Lamps, Canvas Office Landscape, Caper, Celle, Co/Struc, Daisiyone, Distil, Eames, Eco-Dematerialized, Embody, Envelop, Equa 2, Ergon 3, Ethospace, Exclave, Fine-Tune, FlexFront, Flo, Formcoat, Formwork, Ground Cloth, Herman Miller for the Home, Herman Miller for Healthcare, Intersect, Kinemat, Lapjack, Layout Studio, Lifework, Limerick, Live Unframed, Living Office, Locale, Maharam, Meridian, Mirra, Passage, Pellicle, Perspectives, PostureFit, Public Office Landscape, Resolve, Rodney, Sayl, Setu, Thrive, Tu, Wishbone, and Y-Tower are among the registered trademarks of Herman Miller, Inc., and its owned subsidiaries.

™ 8Z Pellicle, About Face, AireWeave, Albert, Backfit, Bubbletack, Burdick Group, Butterfly Back, Celeste, Cellular Suspension, Clam, Compass, Connect, Cosm, Cubert, DOT, Duracare, Durawrap, Eames Soft Pad, EnhancedAccess, Everywhere, Flex-Edge, Flute, Harmonic, Herman Miller Select, Hopsak 2, Intent, Iota, Jaw, Keyless Entry, Keyn Chair Group by Herman Miller, Latitude, Lino, Locale, Logic Mini, Logic Power Access Solutions, Live OS, Loop, Lyris, Lyris 2, Made-to-Measure Storage, Metaform Portfolio, Mora, Motia, Multiscrim, Nelson, Pari, Pixelated Support, Plex, PostureFit SL, Prospect, Q, Renew, Sense, Soft Pad, Stackable, Stackable Storage, Striad, Swoop, Tone, TriFlex, Twist, Ubi, Verus and Wireframe are among the trademarks of Herman Miller, Inc., and its owned subsidiaries.

SM Herman Miller Options is among the service marks of Herman Miller, Inc.

Alexander Girard® is a registered trademark of The Alexander Girard Estate.

Chemsurf® is a registered trademark of Wilsonart International.

Corian® is a registered trademark of E. I. du Pont de Nemours and Company Corporation.

Crypton® is a registered trademark of Crypton, Inc.

DACRON® is a registered trademark of INVISTA S.a r.l.

Edelman® Leather is a registered trademark of Edelman Leather, Inc.

FENIX NTM® is a registered trademark of Arpa Industriale S.p.A.

FLEXNET™ is a trademark of Milliken & Company.

Floor Saver Glide® is a registered trademark of Carpin Manufacturing, Inc.

Geiger® is a registered trademark, and Bumper™, Saiba™, and Ward Bennett™ are trademarks, of Geiger International.

Goetz™ is a trademark of Mark W. Goetz.

Hang-It-All® is a registered trademark of Lucia Eames Demetrios, d.b.a. Eames Office.

Holophane® is a registered trademark of Holophane.

Ingeo™ is a trademark of Cargill Dow LLC.

iPad® is a registered trademark of Apple, Inc.

LifeSize® is a registered trademark of LifeSize Communications, Inc.

Magis®, Bombo®, and Me Too® are registered trademarks of Magis S.p.A.

Microsoft® and Natural® Keyboard are registered trademarks of Microsoft Corporation.

Noguchi® and the Noguchi table configuration (trade dress) are registered trademarks, and Rudder Table™ is a trademark, of The Isamu Noguchi Foundation and Garden Museum.

Place Textiles® is a registered trademark of Place Textiles.

SuperSeat™ is a trademark of Dahti Seating, a division of ITW.